



40 YEARS OF RESEARCH ON NITROGEN

# Proceedings

of the

20th

# Nitrogen

# WORKSHOP

**“Coupling C - N - P - S cycles”**

June 25-27, 2018

Rennes, France  
Couvent des Jacobins  
Conference Centre



ORGANIZING PARTNERS





40 YEARS OF RESEARCH ON NITROGEN



20th  
**N**itrogen  
 WORKSHOP  
**Coupling C - N - P - S Cycles**

June 25-27, 2018 ■ Rennes, France



## SCIENTIFIC COMMITTEE

Patrick Durand (INRA, France); Alberto Sanz Cobeña (Universidad Politecnica de Madrid, Espagne); Claudia Cordovil (Univ Lisboa, Portugal); Tommy Dalgaard (Aarhus University, Danemark); Sofia Delin (SLU Skara, Suède); Jan Willem Erisman (Louis Bolk Instituut, NL); Philippe Faverdin (INRA, France); Josette Garnier (UPMC Paris, France); Chantal Gascuel (INRA, France); Melynda Hassouna (INRA, France); Marie-Hélène Jeuffroy (INRA, France); Penny Johnes (Univ Bristol, UK); Édith Le Cadre (AGROCAMPUS OUEST, France); Tom Misselbrook (Rothamsted, UK); Maria Mooshammer (Univ Vienna, Autriche); Thierry Morvan (INRA, France); Stefaan de Neve (Univ Ghent, Belgique); Virginie Parnaudeau (INRA, France); Sylvie Recous (INRA, France); Karl Richards (Teagasc, Irlande); Zahra Thomas (AGROCAMPUS OUEST, France); Françoise Vertès (INRA, France)

## ORGANISING COMMITTEE (INRA - AGROCAMPUS OUEST)

Patrick Durand; Virginie Parnaudeau; Laure Beff; Sylvaine Bitteur; Michael Corson; Monique Delabuis; Rémi Dupas; Cédric Durand; Karine Derrien; Olivier Godinot; Melynda Hassouna; Tiphaine Labbe; Lucie Lefèvre; Thierry Morvan; Maryvonne Pertue; Thierry Trochet

June 25-27, 2018 ■

Couvent des Jacobins Congres Centre  
Rennes, France

## Sunday June 24 2018

- **18:00 - 21:00** Registration
- **19:00 - 21:00** Welcome reception

## Monday June 25 2018

- **8:30 - 09:45** Registration and Welcome coffee
- **09:45 - 10:00** Welcome address - S. Recous, P. Durand (INRA, France)

### ■ Plenary session I - Landscape studies

La Nef room

Chairperson: Gilles Billen (Sorbonne Université, France)

- **10:00 - 10:30** Keynote presentation

How Nitrogen changed different landscapes?

[Erisman J.W.](#), [Galloway J.N.](#), [Leach A.M.](#), and [Bleeker A.](#)

**10:30 - 10:45** Rebalancing nutrient ratios in streams and rivers - [Wade, A.J.](#), [Stutter, M.](#), [Jarvie, H.P.](#), [Halliday, S.J.](#), [Cooper, D.M.](#)

**10:45 - 11:00** Multi-decadal trajectory of riverine nitrogen, phosphorus and carbon dynamics in rural catchments - [Dupas, R.](#), [Minaudo, C.](#), [Gruau, G.](#), [Ruiz, L.](#), [Gascuel-Odoux, C.](#)

**11:00 - 11:15** The role of coupled macronutrient cycles for ecosystem service supply at the landscape scale - [Reinsch, S.](#), [Blanes, M.A.](#), [Cosby, B.](#), [Glanville, H.](#), [Harmens, H.](#), [Jones, D.](#), [De Sosa, L.L.](#), [Marshal, M.](#), [Mercado, L.](#), [Smart, S.](#), [Winterbourn, J.B.](#), [Emmett, B.A.](#)

**11:15 - 11:30** Decadal trajectories of nitrate input and output in three central German catchments with differing land uses - [Ehrhardt, S.](#), [Musolf, A.](#), [Fleckenstein, J.H.](#), [Attinger, S.](#), [Kumar, R.](#)

**11:30 - 11:45** A landscape scale assessment of environmental controls on the composition of dissolved organic matter delivered to aquatic ecosystems - [Yates, C.A.](#), [Johnes, P.J.](#), and the NERC DOMAINE team

**11:45 - 12:00** Exploring the spatial variability of N<sub>2</sub>O emissions from a grazed upland and lowland site - [Cardenas, L.M.](#), [Charteris, a.F.](#), [Harris, P.](#), [Marsden, K.A.](#), [Harris, I.](#), [Guo, Z.](#), [Beaumont, D.A.](#), [Taylor, H.](#), [Sanfratello, G.](#), [Jones, D.L.](#), [Whelan, M.J.](#), [Chadwick, D.R.](#)

**12:00 - 12:15** Spatially differentiated scenarios to reduce agricultural nitrogen emissions - [Hashemi F.](#), [Olesen J.E.](#), [Dalgaard T.](#), [Børgesen C.D.](#)

- **12:30 - 14:00** Lunch break  
Halle 1

### ■ Plenary session II - Regional studies

La Nef room

Chairperson: [Claudia Cordovil](#) (Instituto Superior de Agronomia, University of Lisbon, Portugal)

- **14:00 - 14:30** Keynote presentation

Nitrogen dynamics in agricultural systems under Mediterranean climate - [Lassaletta L.](#)

**14:30 - 14:45** Potentials for simultaneous improvement of phosphorus and nitrogen management in Austria - [Tanzer, J.](#), [Rechberger, H.](#), [Zessner, M.](#), [Zoboli, O.](#)

**14:45 - 15:00** Greenhouse gases emissions from agriculture in the north of France (1852-2014): consequence of specialisation and intensification - [Garnier J.](#), [Le Noë J.](#), [Marescaux A.](#), [Sanz-Cobena A.](#), [Thieu V.](#), [Billen G.](#)

**15:00 - 15:15** Driving forces of food system nitrogen flows in China, 1990 to 2012 - [Gao Bing](#), [Huang, Wei](#), [Cui Shenghui](#)

**15:15 - 15:30** Assessment of spatially explicit needed increase in nitrogen use efficiency in European agricultural soils in view of air and water quality - [de Vries, W.](#), [Kros, J.](#), [Voogd, J.C.](#), [Louwagie, G.](#)

**15:30 - 15:45** Historic trends in n and s deposition in the UK: 1800 to present - [Dragosits U.](#), [Tomlinson S.J.](#), [Carnell E.J.](#), [Dore A.J.](#), [Misselbrook T.H.](#), [Simpson D.](#), [Langford B.](#), [Mullinger N.](#), [Nemitz E.G.](#), [Sutton M.A.](#)

**15:45 - 16:00** The nitrogen operating space of world food production - [Harchaoui, S.](#), [Chatzimpiros, P.](#)

**16:00 - 16:15** Impact of nitrogen management plans on winter soft wheat yield and nitrogen balance at European scale, simulated with the STICS crop model - [Lecerf, R.](#), [Van Der Velde, M.](#), [Dentener, F.](#)

- **16:30 - 18:00** Coffee break (Mezzanine) and Poster session (Rooms 3, 4, 5-6, level -1)

**17:00 - 17:30** Flash poster presentations (3 minutes each)

- **19:00 - 23:30** Gala dinner and Social event (Breton music and dance)  
Halle 1

**Tuesday June 26 2018**

### ■ Plenary session III - Local process studies

La Nef room

Chairperson: Alberto Sanz-Cobeña (CEIGRAM, Universidad Politécnica de Madrid, Spain)

• **8:30 - 9:00** Keynote presentation

Interactions between C-N-P cycles from the point of view of soil microbial ecology - [Wanek, W.](#), [Mooshammer, M.](#), [Richter, A.](#)

**9:00 - 9:15** Zinc chelates influenced N<sub>2</sub>O emissions and nitrifying and denitrifying communities in a rainfed and irrigated crops - [Montoya, M.](#), [Castellano-Hinojosa, A.](#), [Vallejo, A.](#), [Álvarez, J.M.](#), [Bedmar, E.J.](#), [Recio, J.](#), [Guardia, G.](#)

**9:15 - 9:30** Evaluation of N<sub>2</sub>O and NH<sub>3</sub> emissions from the use of digestate as fertilizer on silage maize - [Verdi L.](#), [Kuikman P.J.](#), [Orlandini S.](#), [Mancini M.](#), [Napoli M.1](#), [Dalla Marta A.](#)

**9:30 - 9:45** Tri-isotope (<sup>13</sup>C, <sup>15</sup>N, <sup>33</sup>P) labeling method to quantify rhizodeposition from a legume - [Stevenel, P.](#), [Frossard, E.](#), [Abiven, S.](#), [Rao, I.M.](#), [Tamburini, F.](#), [Oberson, A.](#)

**9:45 - 10:00** Silicon increases leaf life span in N-deprived brassica Napus l. - [Haddad, C.](#), [Arkoun, M.](#), [Yvin, J.-C.](#), [Etienne, P.](#), [Laine, P.](#)

**10:00 - 10:15** Tillage, simulated animal treading and soil moisture affect denitrification, NO<sub>3</sub> leaching, N<sub>2</sub>O and N<sub>2</sub> emissions - [Thomas, S.M.](#), [Fraser, P.M.](#), [Hu, W.](#), [Clough, T.J.](#)

**10:15 - 10:30** An original experiment to determine impact of catch crop introduction in a crop rotation on soil greenhouse gas emissions - [Tallec, T.](#), [Boussac, M.](#), [Zawilski, B.](#), [Claverie, N.](#), [Brut, A.](#), [Ferlicoq, M.](#), [Ceschia, E.](#), [Mordelet, P.](#), [Le Dantec, V.](#)

**10:30 - 10:45** Sugarcane trash removal reduces ammonia volatilization after surface urea application - [Pinheiro, P.L.](#), [Dietrich, G.](#), [Recous, S.](#), [Giovelli, R. L.](#), [Schu, A. L.](#), [Giacomini, S. J.](#)

**10:45 - 11:00** Effect of N application rate on growing season and spring-thaw N<sub>2</sub>O emissions in Norwegian spring wheat - [Russenes, A.L.](#), [Korsaeth, A.](#), [Bakken, L.R.](#), [Dörsch, P.](#)

• **11:00 - 12:30** **Coffee break (Mezzanine) and Poster session (Rooms 3, 4, 5-6, level -1)**

**11:30 - 12:00** **Flash poster presentations (3 minutes each)**

• **12:30 - 14:00** **Lunch break**  
Halle 1

**Wednesday June 27 2018**

• **7:45 - 13:00** **Scientific tours**

The buses to the scientific tours will leave from “Villejean Université” metro station at the time indicated below. “Villejean Université” is 3 stops from the conference center and 7 from the train station, on Rennes single metro line.

- |                     |  |
|---------------------|--|
| <b>7.45 – 13.00</b> | <b>Tour 1.</b> Catchment observatory               |
| <b>8.15 – 13.00</b> | <b>Tour 2.</b> Livestock experimental facilities   |
| <b>8.15 – 13.00</b> | <b>Tour 3.</b> Platforms for managing animal waste |
| <b>8.15 – 13.00</b> | <b>Tour 4.</b> Commercial organic farm             |

On the way back, buses will stop at Agrocampus Ouest for delegates attending the side event (at **12:45**), and at Villejean-Université metro station for other delegates a few minutes later.

### Plenary session IV - Farming system studies

La Nef room

Chairperson: Sylvie Recous (INRA, France)

• **14:00 - 14:30** Keynote presentation

Sources of nitrogen in cereal production and mitigation options  
[Ladha J.K.](#)

**14:30 - 14:45** Do agricultural practices impact carbon, nitrogen and phosphorus stoichiometry in plants and soils on the long-term? - [Ferchaud, E.](#), [Mary, B.](#), [Keuper, F.](#), [Mollier, A.](#), [Denoroy, P.](#), [Morel, C.](#), [Gallet-Budynek, A.](#), [Houot, S.](#), [Jouany, C.](#), [Hedde, M.](#), [Hinsinger, P.](#), [Jourdan, C.](#), [Bertrand, I.](#)

**14:45 - 15:00** Identifying NEMO: a model-based methodology to identify strategic N application rates in rainfed crop - [Pattey, E.](#), [Mesbah, M.](#), [Jego, G.](#)

**15:00 - 15:15** Ammonia emission from animal manure and mineral fertilizer measured with cheap, reliable & simple to use method - [Sommer, S.G.](#), [Kure, J.L.](#), [Krabben, J.](#), [Duelund L.](#), [Pedersen, S.V.](#)

**15:15 - 15:30** Nitrogen use efficiency as an indicator of farm performance - [Quemada, M.](#), [Brenttrup, F.](#), [Rutkowska, L.](#), [Stoumann, L.](#), [Schulman, M.](#), [Oenema, O.](#)

**15:30 - 15:45** Aquaponics system, a solution to limit nutrient released by fish farming? - [Jaeger, C.](#), [Foucard, P.](#), [Tocqueville, A.](#), [Nahon, S.](#), [Aubin, J.](#)

**15:45 - 16:00** A comparative nitrogen balance of novel cropping systems for feedstock production to future biorefineries: the role of perennial grasses and grass-legumes - [Manevski, K.](#), [Lærke, P.E.](#), [Jørgensen, U.](#)

**16:00 - 16:15** Multi-model assessment of mitigation options for GHG emissions in croplands - [Carozzi, M.](#), [Ehrhardt, F.](#), [Brilli, L.](#), [Bellocchi, G.](#), [Bhatia, A.](#), [De Antoni Migliorati, M.](#), [Doltra, J.](#), [Dorich, C.](#), [Doro, L.](#), [Fitton, N.](#), [Grace, P.](#), [Grant, B.](#), [Giacomini, S.J.](#), [Léonard, J.](#), [Loubet, B.](#), [Massad, R.S.](#), [Mula, L.](#), [Pattey, E.](#), [Sharp, J.](#), [Smith, P.](#), [Smith, W.](#), [Zhang, Q.](#), [Recous, S.](#)

• **16:30 - 17:00** **Coffee break**

• **17:00 - 18:00** **General discussion and Closing session**

Monday June 25 2018 / 17:00 - 17:30 / (Rooms 3, 4, 5-6, level -1)

Flash poster presentations (3 minutes each)

**Session I: Landscape and regional studies**  
(Room 3, level -1)

Identification of Key Atmospheric N Sources at Designated Sites - A Case Study for Special Areas of Conservation in Northern Ireland - Ed Carnell

Feasibility of using industrial anion exchange resin to remove nitrate from tile water - Kari A. Wolf

Climate indicators explaining the variability of carbon, nitrogen and phosphorus emissions to streams in headwater agricultural catchment - Laurent Strohmenger

Exposure time vs. Residence time in upscaling nitrate turnover in the hyporheic zone - Ben Gilfedder

Searching for the control mechanisms of nitrogen removal in a mediterranean riparian forest - Sílvia Poblador

Modelling mitigation scenarios - Catherine Pasquier

Modelling biomass and nutrient flows in agro-food systems at the local scale. Scenario simulation and assessment in a French case-study - Hugo Fernandez-Mena

A comparison of disaggregated nitrogen budgets for Danish agriculture using Europe-wide and national approaches - Hans Kros

**Session III: Local process studies**  
(Room 5-6, level -1)

Protein and amino acid breakdown in soil along a plant fertility gradient - Lucy Greenfield

How do soil and fertiliser type affect  $N_2O$  and  $N_2$  fluxes? A short-term helium oxygen incubation experiment - Caroline Buchen

Interactive plant and soil effects on denitrification potential in agricultural soils - Francois Malique

Nitrogen leaching and nitrous oxide emissions from maize: mitigation potential of Vizura®, a novel formulation of 3,4-dimethylpyrazole phosphate (DMPP) - Drishya Nair

Comparative effect of inorganic n on plant growth and  $N_2$  fixation of ten legume crops - Maé Guinet

The effect of separating pig slurry on nitrogen use efficiency and nitrogen loss pathways from winter wheat on contrasting soil types - Rachel Thorman

What limits sheep urine- $N_2O$  emissions in the uplands: nitrification or C availability? - Karina Marsden

Gaseous emissions of 3 treatments (control, covered, covered + compacted) solid manure heap at storage - Elise Lorinquer

Recovery of nitrogen from depth by grassland species in Norway - Erin Byers

Is the spatial dependence of nitrogen and sulphur combinable for site-specific management? - Carolin Córdova

Nitrogen turnover from contrasting complex organic matrixes - examples from  $^{15}N$  stable isotope studies with compost and digested slurries - Jochen Mayer

**Session IV: Farming system studies**  
(Room 4, level -1)

Fine tuning abatement of ammonia emissions from livestock housing according to impact on protected habitats - David De Pue

Nitrate leaching risk assessment after incorporation of fertilized catch crops - Jeroen De Waele

Nitrous oxide-nitrogen emission factors for a biofuel crop - Heitor Cantarella

Illustrative modelling of nitrate leaching from fertiliser and manure nitrogen applications - Nick Hutchings

Nitrogen supply by roller-crimped agro-ecological service crops in organic cabbage production - Margita Hefner

Acidification prior to drying of digestate solids as a bio-based fertiliser affects nitrogen and phosphorus uptake and fertiliser value when applied to maize - Jingna Liu

A novel platform to provide services in the measurement of potentials for ammonia volatilisation - Génermont S.

Yield of winter crops with legumes monocropped and intercropped with grasses and effects on a subsequent maize crop in a double cropping system - Maria Dolores Baez

Tuesday June 26 2018 / 11:30 - 12:00 / (Rooms 3, 4, 5-6, level -1)

Flash poster presentations (3 minutes each)

### Session II: Regional studies

(Room 3, level -1)

Nitrogen management in French dairy systems: evaluation and enhancement of nitrogen efficiency and economic performance - Sylvain Foray

Regionalized ammonia emission reduction potentials in Germany - Uwe Häussermann

Production, nitrogen exportation and nitrate leaching from managed grasslands in France - Anne-Isabelle Graux

SYNERGY: a model to assess the economic and environmental impacts of increasing regional protein self-sufficiency - Julia Jouan

Model assessment and validation of ammonia concentrations at high spatial and temporal resolution over Europe - Ge Xinrui

Using the bottom-up inventory method cadastre\_NH<sub>3</sub> to assess the efficiency of mitigation technics to reduce ammonia emissions in France - Karine Dufosse

Global nitrous oxide database for improved analysis and extrapolation - Chris Dorich

The problem of regional nutrient imbalances - Shabtai Bittman

### Session III: Local process studies

(Room 5-6, level -1)

Modelling C-N-P-K soil dynamics in a context of repeated composts applications - Agathe Revallier

Impact of the urease inhibitor Limus® on agronomic and environmental parameters in temperate grassland - Dominika Krol

Gas emissions during solid manure management at housing and storage stages from dairy cattle in contrasted feeding and climatic situations - Nadège Edouard

Predicting C and N fate from mixture of sugarcane straw and organic fertilizers. Mechanistic approach by modeling - Vladislav Kyulavski

Quality of carbon compounds of maize root and shoot litter controls short-term CO<sub>2</sub> and N<sub>2</sub>O emissions from agricultural soils - Pauline Sophie Rummel

Nitrification inhibitor N-LOCKTM with OPTINYTETM technology - research on environmental and agricultural benefits in grain corn and oilseed rape - Marcin Dzikowski

Maintaining soil nitrogen and carbon stocks in long-term grassland experiments in Norway - Levina Sturite

Nitrogen leaching after solid manure application in autumn - Sofia Delin

Human urine as a nitrogen fertilizer: a greenhouse experiment - Tristan Martin

Nutrient cycling in grassland systems - Kate Le Cocq

The impacts of soil incorporation of conventional and novel organic fertilizers on N availability and microbial parameters - Mesfin Gebremikael

### Session IV: Farming system studies

(Room 4, level -1)

Implications of the cover crop termination date on n and water cycles - Jose L. Gabriel

Fertilizer strategies to improve NUE in grazed dairy pastures - Andrew Smith

Modelling the effect of wide ranging drip irrigation regimes and N-fertigation rates on potato growth and production on a coarse sand - Finn Plauborg

Nitrogen input mapping at the field scale using Remotely Piloted Aircraft Systems imagery - Juliette Maire

Manure n plays a dual role in C stabilization and N supply soil functions – evidence from long-term field studies - Martin Chantigny

Carbon and nitrogen sequestration and nitrate leaching mitigation by cover crops - Miguel Quemada

Grain yield and nitrogen use efficiency (NUE) response in old and new durum wheat genotypes to different fertilization timing - Paola Gioacchini

Decision rules for environment-friendly wheat N fertilization: combining crop model and viability theory - Arthur Lenoir

Conserving carbon stocks and mitigating nitrous oxide emissions by using a forage crop rotation instead of continuous maize cultivation - Friedhelm Taube

# PROGRAMME

June 25-27, 2018 ■

Couvent des Jacobins congrès centre  
Rennes, France

20th  
**N**itrogen  
WORKSHOP  
Coupling C - N - P - S Cycles

<b>Session I: N cycle in landscapes - Oral presentations.....</b>	<b>16</b>
Keynote presentation: How Nitrogen changed different landscapes.....	17
Erisman J. W., Galloway J. N., Leach A. M., and Bleeker A.	
Rebalancing nutrient ratios in streams and rivers .....	18
Wade, AJ., Stutter, M., Jarvie, HP., Halliday, SJ., Cooper, DM.	
Multi-decadal trajectory of riverine nitrogen, phosphorus and carbon dynamics in rural catchments	20
Dupas, R., Minaudo, C., Gruau, G., Ruiz, L., Gascuel-Odoux, C.	
The role of coupled macronutrient cycles for ecosystem service supply at the landscape scale.....	22
Reinsch, S., Blanes, M.A., Cosby, B., Glanville, H., Harmens, H., Jones, D., De Sosa, L.L., Marshal, M., Mercado, L., Smart, S., Winterbourn, J.B., Emmett, B.A.	
Decadal trajectories of nitrate input and output in three central German catchments with differing land uses.....	24
Ehrhardt, S., Musolff, A., Fleckenstein, J.H., Attinger, S., Kumar, R.	
Dissolved organic matter delivered to aquatic ecosystems.....	26
Yates, C.A., Johnes, P.J., and the NERC DOMAINE team	
Exploring the spatial variability of N <sub>2</sub> O emissions from a grazed upland and lowland site.....	29
Cardenas, L.M., Charteris, a.F., Harris, P., Marsden, K.A., Harris, I., Guo, Z., Beaumont, D.A., Taylor, h., Sanfratello, G., Jones, D.L., Whelan, M.J., Chadwick, D.R	
Spatially differentiated scenarios to reduce agricultural nitrogen emissions .....	32
Hashemi F., Olesen J.E., Dalgaard T., Børgesen C.D.	
<b>Session I: N cycle in landscapes - Highlighted posters .....</b>	<b>34</b>
Better understanding nitrate sources and sinks in agricultural watersheds .....	35
Xia, Yongqiu, Weller Donald E., Yan Xiaoyuan	
Identification of key atmospheric N sources at designated sites - a case study for special areas of conservation in Northern Ireland.....	37
Carnell, E.J., Dore, A.J., Misselbrook, T.H, Sutton M.A. & Dragosits, U.	
Feasibility of using industrial anion exchange resin to remove nitrate from tile water .....	39
Wolf, K.A., Gupta, S.C.	
Climate indicators explaining the variability of carbon, nitrogen and phosphorus emissions to streams in headwater agricultural catchment.....	42
Strohmenger, L., Fovet, O., Gascuel-Odoux, C.	
Exposure time vs. residence time in upscaling nitrate mass loss in the hyporheic zone.....	44
Gilfedder, B.S., Durejka, S., Thomas, Z., Le lay, H., Frei, S.	
Searching for the control mechanisms of nitrogen removal in a mediterranean riparian forest.....	47
Poblador, S. , Thomas, Z. , Rousseau-Gueutin, P. , Lupon, A. , Sabaté, S., Sabater, F.	
Modelling mitigation scenarios on a landscape in Central France.....	49
Pasquier, c., Benhamou, C. , Franqueville, D. , Drouet, J.L., Henault, C.	



**Session I: N cycle in landscapes - Posters ..... 51**

GIS-based estimation of shallow groundwater nitrate concentrations: from point measurements to the landscape scale..... 52

Knoll, L., Breuer, L., Bach, M.

Tracing the fate of <sup>15</sup>N-labelled animal manure in the environment..... 54

Frick, H., Oberson, A., Frossard, E., Wettstein, H.-R., Bünemann, E. K.

High water tables during winter have no impact on winter wheat nitrogen uptake and yields under Danish conditions ..... 56

Deichmann, M. M., Børgesen, C. D., Thomsen, I. K., Andersen, M. N.

Increasing the nitrogen use efficiency and consequently the groundwater quality In the Gäu region, Switzerland ..... 58

Wey, H., Hunkeler, D., Buenemann, E.K.

Upscaling water and nutrient use efficiencies from field to catchment scale: a case study in the Selke catchment, Germany ..... 60

Silva, J.V., Jomaa, S., Chukalla, A., Yang, X., Merbach, I., Rode, M., Anten, N.P.R., van Ittersum, M.K., Reidsma, P.

In-stream nitrate assimilatory uptake analysis based on high frequency measurements ..... 62

Yang, X., Jomaa, S., Rode, M.

Agricultural nitrogen budget and groundwater quality in a portuguese vulnerable zone ..... 64

Faro, A.F., Cameira, M.R., Rolim, J. Cordovil, C., Dragosits, U.

Indirect emission of nitrous oxide from rivers: first results of a study on the Loir watershed..... 67

Grossel, A., Pasquier, C., Bourennane, H., Henault, C.

Plant growth indicates soil spatial variability related to water shortage and nitrate leaching vulnerability..... 69

Haberle, J., Svoboda, P., Šimon, T., Lukáš, J., Kurešová, G., Křížová, K. Madaras, M.

Assessment of artificial wetland for nitrate removal from subsurface drained watershed ..... 71

Tournebize, J., Chaumont, C., Blandin, M., Soosaar, K., Hansen, R., Muhel, M., Teemusk, A., Pärn, J., Mander, U.

Evaluating scenarios of land management practices in contrasted landscapes using a nitrogen landscape model ..... 73

Casal L., Durand P., Akkal-Corfini N., Benhamou C., Salmon-Monviola J., Ferrant S., Probst A., Probst J.L., Sauvage S., Vertès F.

N<sub>2</sub>O emissions in response to the addition of nitrification inhibitors to digestate: a case study in the Po Valley (Northern Italy) ..... 76

Chiodini, M.E., Perego, A., Sanz-Gomez, J., Tarlazzi, S., Acutis, M.

Changes in land use and impact in water quality for water supply. Example of “Cstelo de Bode” in Portugal ..... 78

Cordovil, C.M.d.S., Reis, R., Miranda, R., Vale, M.

Eutrophication: causes, mechanisms, consequences and predictability ..... 80

Pinay, G., Gascuel-Oudoux, C., Ménesguen, A., Souchon, Y., Le Moal, M. , Durand, P., Levain , A., Pannard, A., Souchu, P., Etrillard, C., Moatar, F.

<b>Session II: Regional studies – Oral presentations .....</b>	<b>82</b>
Keynote presentation: Nitrogen dynamics in agricultural systems under Mediterranean climate.....	83
Lassaletta, L.	
Potentials for simultaneous improvement of phosphorus and nitrogen management in Austria.....	85
Tanzer, J., Rechberger, H., Zessner, M., Zoboli, O.	
Greenhouse gases emissions from agriculture in the North of France (1852-2014): Consequence of specialisation and intensification .....	87
Garnier J., Le Noë J., Marescaux A., Sanz-Cobena A., Thieu V., Billen G.	
Driving forces of food system nitrogen flows in China, 1990 to 2012 .....	89
Gao Bing, Huang Wei, Cui Shenghui	
Assessment of spatially explicit needed increase in nitrogen use efficiency in european agricultural soils in view of air and water quality.....	91
de Vries, W., Kros, J., Voogd, J.C., Louwagie, G	
Historic trends in N and S deposition in the UK: 1800 to present .....	94
Dragosits U., Tomlinson S.J., Carnell E.J., Dore A.J., Misselbrook T.H., Simpson D. Langford B., Mullinger N., Nemitz E.G., Sutton M.A.	
The nitrogen operating space of agriculture: connecting nitrogen self-sufficiency to maximum net production .....	96
Harchaoui,S., Chatzimpiros, P.	
Impact of nitrogen management plans on winter soft wheat yield and nitrogen balance at European scale, simulated with the stics crop model .....	99
Lecerf, R., Van Der Velde, M., Dentener, F.	
<b>Session II: Regional studies - Highlighted posters.....</b>	<b>101</b>
Modelling biomass and nutrient flows in agro-food systems at the local scale. Scenario simulation and assessment in a French case-study .....	102
Fernandez-Mena H., Nesme T., MacDonald G.K., Pellerin S.	
A comparison of disaggregated nitrogen budgets for Danish agriculture using Europe-wide and national approaches .....	105
Kros, J., Hutchings, N.J., Toft Kristensen, I., Sillebak Kristensen, I., Duus Børgesen, C., Voogd, J.C.H., Dalgaard, T., de Vries, W.	
Nitrogen management in french dairy systems: evaluation and enhancement of nitrogen efficiency and economic performance .....	107
Foray, S., Vertes, F., Godinot, O.	
Regionalized ammonia emission reduction potentials in Germany.....	110
Häussermann, U., Klement, L., Bach, M., Breuer, L.	
Production, nitrogen exportation and nitrate leaching from managed grasslands in France .....	112
Graux, A.-I., Resmond, R., Casellas, E., Delaby, L., Faverdin, P., Le Bas, C., Meillet, A., Pomeon, T., Raynal, H., Ripoche, D., Ruget, F., Therond, o., Vertes, f., Peyraud, J.-L.	
SYNERGY: a model to assess the economic and environmental impacts of increasing regional protein self-sufficiency.....	114
Jouan, J., Carof, M., Ridier, A.	

Model assessment and validation of ammonia concentrations at high spatial and temporal resolution over Europe .....	116
Ge, X., Schaap, M., Kros, J., Kranenburg, R., Segers, A.J., de Vries, W.	
Using the bottom-up inventory method cadastre_NH <sub>3</sub> to assess the efficiency of mitigation techniques to reduce ammonia emissions in France.....	118
Dufosse, K., Gilliot, J.-M., Ramanantenasoa M. M. J., Voylokov P., Genermont, S., Bessagnet, B.	
Estimation of the growth of NH <sub>3</sub> emissions from anaerobic digestion in the UK.....	121
Tomlinson, S.J., Schmidt-hansen, A., Sutton, M., Tang, y.s., Dragosits, U.	
Global nitrous oxide database for improved analysis and extrapolation .....	124
Dorich, C.D., Conant, R.T., Grace, P., Snow, V., Vogeler, I., Van Der Weerden, T., Albanito, F.	
The problem of regional nutrient imbalances.....	127
Bittman, S. Sheppard, S.C. Poon, D.Hunt D.E.	
<b>Session II: Regional studies - Posters .....</b>	<b>129</b>
Nitrogen use effectiveness of territorial agro-food systems: a long term perspective at the French regional scale.....	130
Billen, G., Le Noe, J., Garnier, J.	
Regional N and P cycling in agro-food systems: long term historical and future trajectories in France .....	132
Le Noë, J., Billen, G., Garnier, J.	
Nitrogen and carbon footprints of contrasting dairy farm systems in China and New Zealand.....	134
Ledgard, S.F., Wei, S., Wang, X., Falconer, S., Zhang, N., Zhang, X., Ma, L.,	
An overview of nitrogen fertilisation practices in France .....	136
Dufosse, K., Ramanantenasoa M. M. J., Mignolet C., Trochard R., Gilliot, J.-M., Bessagnet, B., Genermont, S.	
Large scale modelling of nitrate leaching from arable land in Germany .....	138
Klement, L., Bach, M., Breuer, L., Nendel, C., Kersebaum, K.-C., Stella, T., Berg-Mohnicke, M.	
Regulation of organic nitrogen in France .....	140
Loyon, L.....	
The configuration of the agro-food system in the Mediterranean basin: implications for food security in a vulnerable area .....	142
Lassaletta, L., Bondeau, A., Sanz-Cobena, A., Quemada, M., Cramer, W.	
<b>Session III: Local process studies – Oral presentations .....</b>	<b>144</b>
Keynote presentation: Interactions between C-N-P cycles from the point of view of soil microbial ecology .....	145
Wanek, W., Mooshammer, M., Richter, A.	
Zinc chelates influenced N <sub>2</sub> O emissions and nitrifying and denitrifying communities in two different crop systems.....	147
Montoya, M., Castellano-Hinojosa, A., Vallejo, A., Álvarez, JM.1, Bedmar, EJ.2, Recio, J., Guardia, G.	
Evaluation of N <sub>2</sub> O and NH <sub>3</sub> emissions from the use of digestate as fertilizer on silage maize .....	149
Verdi L., Kuikman P.J., Orlandini S., Mancini M., Napoli M., Dalla Marta A.	

Tri-isotope ( <sup>13</sup> C, <sup>15</sup> N, <sup>33</sup> P) labeling method to quantify rhizodeposition from a legume .....	152
Stevenel, P., Frossard, E., Abiven, S., Rao, I.M., Tamburini, F., And Oberson, A.	
Silicon increases leaf life span in N-deprived Brassica Napus L. ....	154
Haddad, C., Arkoun, M., Yvin, J.C., Etienne, P., Laine, P.	
Tillage, simulated animal treading and soil moisture affect denitrification, NO <sub>3</sub> leaching, and N <sub>2</sub> O and N <sub>2</sub> emissions .....	156
Thomas, S.M., Fraser, P.M., Hu, W., Clough, T.J.	
An original experiment to determine impact of catch crop introduction in a crop rotation on soil greenhouse gas emissions.....	158
Tallec, T., Boussac, M. , Zawilski, B. , Claverie, N. , Brut, A. , Ferlicoq, M. , Ceschia, E. , Mordelet, P. , Le Dantec, V.	
Sugarcane trash removal reduces ammonia volatilization after surface urea application.....	160
Pinheiro, P. L., Dietrich, G., Recous, S., Giovelli, R. L., Schu, A. L., Giacomini, S. J.	
Effect of N application rate on growing season and spring-thaw N <sub>2</sub> O emissions in Norwegian spring wheat.....	162
Russenes, A.L., Korsæth, A, Bakken, L.R., Dörsch, P.	
<b>Session III: Local process studies – Highlighted posters .....</b>	<b>165</b>
Protein and amino acid breakdown in soil along a plant fertility gradient.....	166
Greenfield, L.M., Hill, P.W., Paterson, E., Baggs, E.M., Seaton, F.M., Jones, D.L.	
How do soil and fertiliser type affect N <sub>2</sub> O and N <sub>2</sub> fluxes? A short-term helium oxygen incubation experiment .....	168
Buchen, C., Hagemann, U., Augustin J.	
Interactive plant and soil effects on denitrification potential in agricultural soils .....	170
Malique F., Ke P., Maurer D., Dannenmann M., Butterbach-Bahl K.	
Nitrogen leaching and nitrous oxide emissions from maize: mitigation potential of VIZURA®, a novel formulation of 3,4-dimethylpyrazole phosphate (DMPP).....	172
Nair, D., Sanz-Gomez, J., Brendstrup, I., Petersen, S.O.	
Comparative effect of inorganic N on plant growth and N <sub>2</sub> fixation of ten legume crops .....	174
Guinet, M., Nicolardot, B., Durey, V., Revellin, C., Lombard, F., Pimet, E., Bizouard, F., Voisin, A.S.	
The effect of separating pig slurry on nitrogen use efficiency and nitrogen loss pathways from winter wheat on contrasting soil types .....	176
Thorman, R.E., Munro, D.G, Bennett, G., Edwards, D.J, Kingston, H.L, Williams, J.R.	
What limits sheep urine-N <sub>2</sub> O emissions in the uplands: nitrification or C availability?.....	178
Marsden, K.A., Holmberg, J.a., Jones, D.L., CharTeris, A. F., Cárdenas, L.M. and CHADWICK, D.R.	
Gaseous emissions of 3 treatments (control, covered, covered+compacted) solid manure heap at storage.....	180
Lorinquer, E., Charpiot, A., Fougere, M., Lecomte, M., Robin, P.	
Recovery of nitrogen from depth by grassland species In Norway.....	182
Byers, E., Raut, P., Dörsch, P., Eich-Greatorex, S., Bleken, M.A.	

Is the spatial dependence of nitrogen and sulphur combinable for site specific management? .....	184
Córdova, C.	
Nitrogen turnover from contrasting complex organic matrixes - examples from <sup>15</sup> N stable isotope studies with compost and digested slurries .....	186
Mayer, J., Koeppe, P., Dubois, A., Hutter, M.	
Modelling C-N-P-K soil dynamics in a context of repeated composts applications .....	188
Revallier, A., Orvain, M., Bisinella De Faria, A. B., Naves-Maschietto, G., Albuquerque, M., Houot, S., Hartman, M., Parton, B.	
Impact of the urease inhibitor Limus® on agronomic and environmental parameters in temperate grassland.....	190
Krol, D.J., Forrestal, P.J., Wall, D., Lanigan, G.J., Sanz-Gomez, J., Knauer, M., Ford, I., Kelly, G., Richards, K.G.	
Gas emissions during solid manure management at housing and storage stages from dairy cattle in contrasted feeding and climatic situations .....	192
Edouard, N., Robin, P., Almeida, J.G.R., Alves, T.P. , Lambertson, P., Lorinquer, E.	
Predicting C and N fate from mixture of sugarcane straw and organic fertilizers. Mechanistic approach by modeling.....	194
Kyulavski, V. , Thuriès, L., Recous, S. , Paillat, J.-M., Garnier, P.	
Quality of carbon compounds of maize root and shoot litter controls short-term CO <sub>2</sub> and N <sub>2</sub> O emissions from agricultural soils.....	196
Rummel, P.S., Pfeiffer, B., Pausch, J., Dittert, K.	
Nitrification inhibitor N-Lock with Optinyte Technology – research on environmental and agricultural benefits in grain corn and oilseed rape.....	198
Dzikowski, M., Peterson, M., Lourdet, Y.	
Maintaining soil nitrogen and carbon stocks in long-term grassland experiments in Norway.....	200
Sturite I., Opstad S.	
Nitrogen leaching after solid manure application in autumn before spring sowing .....	202
Delin, s.	
Human urine as a nitrogen fertilizer: a greenhouse experiment.....	204
Martin, T.M.P., Levavasseur, F., Esculier, F., , Houot, S.	
Nutrient cycling in grassland systems; N, P and C cycling in a plot experiment on the North Wyke farm platform.....	207
Le Cocq, K., McAuliffe, G., Horrocks, C., Darch, T., Takahashi, T., Blackwell, M., Misselbrook, T., Lee, M.R.F., Cardenas, L.	
The impacts of soil incorporation of conventional and novel organic fertilizers on N availability and microbial parameters .....	209
Gebremikael, M., Ranasinghe, A., Salehi, P., Pipan, M., De Neve, S.	

**Session III: Local process studies – Posters .....211**

Substitution of urea by calcium ammonium nitrate in a rainfed semi-arid crop: effect on N oxides emissions, yield and quality .....	212
Guardia, G.; Sánchez-Martín, L.; Sanz-Cobena, A.; Rodríguez De Quijano, M.; Fuertes-Mendizábal, T., González-Murua, C., Vallejo, A.	
Nitrogen and phosphorous availability of organic fertilizers- a greenhouse study .....	214
Palmborg, C., Hahlin A.-H.	
Impact of conventional tillage and no-tillage cover crops on nitrous oxide emissions from vineyards in mediterranean portugal.....	216
Marques, F.J.M., Pedroso, V., Trindade, H., Pereira, J.L.S.	
Ammonia and greenhouse gas emissions from a breeding hen building in Portugal.....	218
Pereira, J.L.S., Ferreira, S., Conde, A., Ferreira, P., Pinheiro, V., Trindade, H.	
Residual effect and nitrogen use efficiency of N fertilizers in a maize/wheat rotation.....	220
Valentin, F., Calvo, M., Gabriel, J.L., Alonso-Ayuso, M., Quemada, M.	
Long – term consequences of unbalanced fertilization with nitrogen and phosphorus .....	222
Rutkowska, A.	
Nitrogen balance and crop nitrogen uptake in long-term lysimetric investigation.....	225
Miroslav F., Smatanová M., Hynšt J., Němec P.	
The effect of nitrogen application methods on maize ( <i>zea mays</i> l.) yield .....	227
Széles, A., Horváth, É., Kith, K., Ragán, P.	
Agent based modelling of sheep movement and urine deposition to support N <sub>2</sub> O emission estimates in upland pastures.....	229
Johnson, S.C.M., Whelan, M.J., Balzter, H., Lush, L., King, A.J., Tucny, E., Wilson, R.P., Perroto-Baldivieso, H.L., Cardenas, L., Charteris, A.F., Marsden, K.A., Harris, I., Holmberg, J. Chadwick D.	
Comparison between different stabilized nitrogen fertilizers in maize crop.....	231
Mateo-Marín, N., Quílez, D., Guillén, M., Isla, R.	
N <sub>2</sub> O emissions during and after legume crops cultivation .....	233
Nicolardot, B., Bizouard, F., Coffin, A., Guinet, M., Henault, C., Lombard, F., Pauthenet, G., Pimet, E., Voisin, A.S.,	
An incubation study about the potential of high organic carbon soil amendments to improve agricultural nitrogen retention capacity .....	235
Reichel R, Wei J, Islam M.S., Amelung W., Schmid C. Schröder P., Schloter M., Brüggemann N	
Effects of long-term application of mineral nitrogen and manure on selected soil properties.....	237
Pikuła D., Martyniuk S.	
Short-term fate of <sup>15</sup> N in maize on tropical sandy soils as affected by N form, tillage and biochar addition .....	239
Munera-Echeverri, J.L., Martinsen, V., Obia, A.,dörsch, P., Mulder, J.	
Effect of fertilizer N forms on root growth in winter wheat ( <i>Triticum aestivum</i> L.) .....	241
Kirschke, T., Thiel, E., Christen, O.	

Effect of N-fertilizers on the abundance of nitrification and denitrification genes in bulk and rhizospheric soil of tomato and beans plants .....	243
Castellano-Hinojosa, A., González-López, J., Bedmar E.J.	
Can N <sub>2</sub> O isotopocules help to improve our understanding of N <sub>2</sub> O processes during grassland conversion to maize cropping? .....	245
Buchen, C., Lewicka-Szczebak, D., Helfrich, M., Flessa, H., Well, R.	
Is soybean yield limited by nitrogen supply? .....	247
Cafaro La Menza, N., Monzon, J.P., Specht, J. E., Grassini, P.	
Simulation of long term C & N dynamics in a Northern agro-ecosystem with DNDC.....	249
Jégo, G., Crépeau, M., Chantigny, M., D'Amours, E., Smith, W., Grant, B., Lafond, J., Angers, D.	
Dimethyl pyrazol-based nitrification inhibitors effect on N cycle bacteria responsible of N <sub>2</sub> O emissions in grassland.....	251
Fuertes-Mendizabal, T., Huerfano, X., Torralbo, F., Vega-Mas, I., Menendez, S., Gonzalez-Murua, C., Estavillo, J.M.	
3,4-dimethylpyrazole-succinic acid (DMPSA) nitrification inhibitor effectively reduces N <sub>2</sub> O emissions in a winter wheat crop under no-tillage management .....	253
Corrochano-Monsalve, M., Huérfano, X., Fuertes-Mendizabal, T., Estavillo, J.M., González-Murua, C.	
Effect of N fertilization rate and soil tillage on N <sub>2</sub> O emissions from irrigated corn in a Mediterranean agroecosystem	
Pareja-Sánchez, E., Plaza-Bonilla, D., Álvaro-Fuentes, J., Cantero-Martínez C. ....	255
Evaluation of the sensitivity of portable chlorophyll meters to estimate leaf chlorophyll and N contents under excessive N conditions.....	257
Padilla, F.M., Peña-Fleitas, M.T., De Souza, R., Giménez, C., Thompson, R.B., Gallardo, M.	
Leaf nitrogen and <sup>δ15</sup> N fractionation during resorption in beech and larch trees in Japan .....	259
Lopez C, M.L., Enta, A., Fujiyoshi, L. Yamanaka, T., Oikawa, A.	
Linking biochar properties with its ability to promote n <sub>2</sub> o reduction to N <sub>2</sub> in agricultural soils.....	261
Pascual De Vega, M.B., Sánchez-Monedero, M.A., Cayuela, M.L.	
Monitoring RNA induction to evaluate nitrogen absorption and assimilation following biostimulant application on wheat ( <i>Triticum aestivum</i> L.).....	263
Kremer, L., Belval, L., Besson, M., Meyer, L., Haas, J., Benbrahim, M.	
Effects of a natural nitrogen-nutritional agent on winter wheat ( <i>Triticum aestivum</i> ).....	266
Bras, P.Y. , Levivier, S. Klarzynski, O.	
Effects of organic waste application on N <sub>2</sub> O emissions and N leaching in sugarcane plantation soils in Reunion Island.....	269
Poultney, D.M, Versini, A., Thuries, L.	
N <sub>2</sub> O mitigation potential of N-stabilizers applied with urea to winter oilseed rape .....	271
Thiel, E., Spott, O., Kreuter, T., Lietsch, A., Schuster, C.	
Effect of delayed N application on spring barley productivity.....	274
Hackett, R.	

N <sub>2</sub> O soil emissions after biochar amendment: contrasting responses depending on the original feedstock .....	276
Sánchez-García, M., Sánchez-Monedero, M.A, Cayuela, M.L.	
N <sub>2</sub> O emission during sugarcane cultivation with different levels of straw removal .....	278
Giacomini, S. J., Pinheiro, P. L., Dietrich, G., Recous, S., Pollet, C. S., Bick, R. A.	
Ammonia loss from urea and calcium ammonium nitrate after application to winter wheat and winter oilseed rape .....	280
Spott, O., Kreuter, T., Schuster, C.	
A comparison of the nitrogen use efficiency and nitrogen losses attributed to three fertiliser types applied to an intensively managed silage crop .....	283
Cowan N., Levy P, Moring A,. Loubet B, Polina Voylokov P,. Skiba U	
Nitrogen use efficiency of raw and anaerobically digested slurries: a field study with different <sup>15</sup> N methods.....	285
Hutter, M., Krebs, R., Mayer, J.	
Interactive effects of the factors controlling urine-N <sub>2</sub> O emissions from an upland soil.....	288
Charteris, A.F., Marsden, K.A., Castellano-Hinojosa, A., Loick, N., Chadwick, D.R., Ravella, S.R., Mead, A., Field, N., Whelan, M., Cárdenas, L.M.	
Optimizing nitrogen rate of pearl millet under arid and semi-arid environments .....	290
Ullah, A., Ahmad, A., Khaliq, T. Saeed, U. Ahmad, I. Hussain, J. Mahmood, A.	
Evaluation of the efficiency of a new additive to UAN 32 on the improvement of the nitrogen assimilation by wheat.....	292
Maignan, VM., Geliot, PG.	
Influence of pea, lentil and faba bean on soil microbial activities implicated in sulfur and nitrogen mineralization.....	294
Slezack-Deschaumes, S., Genestier J., Voisin, A.S., Piutti, S.	
Soil nitrogen dynamics in intercropped wheat ( <i>Triticum aestivum</i> ) and white lupin ( <i>Lupinus albus</i> )	297
De Oliveira, A. B.; Hinsinger, P.; Yvin, J. -C.; Arkoun, M.; Le Cadre, E.	
Quantification of ammonia, nitrous oxide and methane emissions following biogas digestate application in an orchard field in the North China Plain .....	299
Deharde, A., Yuan, Y., Gao, Z., Ma, W., Roelcke, M., Nieder, R.	
Effects of the nitrification inhibitor DMPSA on nutrient uptake, nitrate leaching and crop growth in barley and potato in pot and field trials.....	302
Pacholski , A., Goebel, M., Meyer, A., Mannheim, T.	
Calibrating airborne multispectral data to autumnal fresh matter and N content of winter oilseed rape .....	304
Bukowiecki, J., Pahlmann, I., Kage, H.	
Impact of band application at 2-5 cm of pelleted meat bone meal on winter oilseed rape yield.....	306
Engström, L., Delin, S.	
First analysis of the nitrate leaching risk for different fertilisers in the Persephone project .....	308
Daigneux, B., Molitor, N., Gennen, J., Debbaut, V., Tsachidou, B.	



Biodiversity of indigenous rhizobia nodulating <i>Phaseolus vulgaris</i> in Croatia.....	310
Rajnovic, I., Ramírez-Bahena, M.H., Sánchez Juanes, F., González Buitrago, J.M., Kajic, S., Peix, A., Velázquez, E., Sikora, S.	
Simulated nitrogen deposition in two Italian beech forests exposed to different climate conditions: effect on soil nitrogen cycling .....	312
Marcolini, G., Gioacchini, P., Mazzenga, F., D'andrea, E., Ravaioli, D., Muzzi, E., Mezzini, E., Matteucci, G., Magnani, F.	
Effects of n fertilizer forms and soil pH on N <sub>2</sub> O emissions during nitrification.....	314
Tierling, J., Lebender, U., Brueck, H.	
Estimating wheat grain yield and N uptake by multispectral imaging.....	316
Corti, M., Cabassi, G., Cavalli, D., Vigoni, A., Ortuani, B., Degano, L., Pricca, N., Marino Gallina, P.	
Effect of modifying root distribution on growth of wheat and net nitrogen budgets.....	318
Buckingham S, Jones S, Crawford C, Bingham I J	
Compound-specific <sup>15</sup> N stable isotope probing to provide novel insights into the response of bacterial and fungal communities in soil to fertiliser.....	320
Reay, M.K., Jones, D.L., Evershed, R.P.	
Long term effect of NPK and manure fertilisation and crop/grass rotations on soil C and N and plant N concentrations.....	322
Palmborg, C., Carlsson, G., Albertsson, J. Jensen, E.S.	
Climate and management effects on N <sub>2</sub> O emissions from two crop sites in the Southwestern France .....	324
Bigaignon, L., Le Dantec, V., Zawilski, B., Granouillac, F., Claverie, N., Brut, A., Ceschia, E., Mordelet, P., Tallec, T.	
Analyzing and modeling the variability of soil organic nitrogen mineralization from five years of field measurements.....	326
Beff, L., Lambert, Y., Germain, P., Louis, B., Mary, B., Beaudoin, N., Morvan, T.	
Estimation of delayed effect of some organic matter types on sugarcane .....	328
Fevrier A., Paillat J., Marion D.	
A novel platform to provide services in the monitoring of greenhouse gases for agricultural systems .....	331
Decuq, C., Genermont, S., Loubet, B., Cellier, C. Gabrielle, B.	
Comparing ammonia volatilisation of livestock effluents having undergone different treatments in field conditions .....	333
Voylokov, P., Loubet, B., Houot, S., Savoie, A., Genermont, S.	
Effect of urease and nitrification inhibitors on nitric and nitrous oxide emissions, and yield in an irrigated maize crop .....	335
Recio, J., Montoya, M., Guardia, G., Gines, C., Sanz-Cobeña, A. Vallejo, A., Álvarez, JM.	
Higher nitrogen use efficiency under reduced tillage.....	337
Ernfors, M., Jensen, ES..	
N fertilizer forms affect nitrous oxide emissions in a fertigated potato system.....	339
Lebender, U., Tierling, J., Brueck, H.	

Contribution of <i>Escherichia coli</i> for reducing greenhouse gas and ammonia emissions from treated cattle-slurry liquid fraction.....	341
Miranda, C., Soares, A.S., Teixeira, C.A., Coelho A.C., Trindade, H.	
Changes of phosphorus availability in soils under different nitrogen fertilization levels in a long-term field experiment .....	343
Čermák, P., Mühlbachová, G., Káš, M., Marková, K., Pechová, M.	
Changes of sulphur availability in soils under different nitrogen fertilization levels in a long-term field experiment .....	345
Mühlbachová, G., Čermák, P., Káš, M., Marková, K., Pechová, M.	
Effects of suppression of herbicides on vineyard nitrogen status, and soil microbial and chemical indicators.....	347
Durocher E., Langenfeld, A., Ley L., Klein C., Thiollet-Scholtus M., Nassr, N.	
Legume nutrients management for sustaining crop productivity and soil biodiversity .....	350
Toleikienė, M., Arlauskienė, A., Kadžiulienė, Ž., Supronienė, S.	
Towards a better understanding of C and N cycling in agricultural soils.....	352
Samson, M-E., Chantigny, M., Angers, D. Menasseri-Aubry, S. Vanasse, A.	
Urea deep placement for transplanted rice: complementarity of <sup>15</sup> N-labelling and ammoniacal N diffusion studies to understand the fertilizer-N efficiency.....	354
Gaudin, R., D'Onofrio, G.	
A comprehensive analysis of N-losses from urine patches in dairy pasture systems .....	356
Carozzi, M., Bretscher D., Voglmeier K., Ammann, C.	
Increasing Nutrient Use Efficiency by using controlled release fertilizers fitted to the crop needs... 358	
Clemens, R., Terrones, C., Pardossi, A., Incrocci, L.	
Polysulphate - a new multi nutrient fertilizer with sulphur, potassium, magnesium and calcium - for better nitrogen use efficiency .....	360
Imas, P.	
Impact of anaerobic digestion on N balance in a crop succession fertilized with treated or untreated manures: first results.....	362
Savoie A., Pasquier C., Ayzac A., Voylokov P., Lemekhova A., Genermont S., Loubet B., Henault C., Houot S.	
No-tillage reduces yield-scaled nitrous oxide emissions in rainfed mediterranean conditions: a long-term field and modelling approach.....	364
Plaza-Bonilla, D., Álvaro-Fuentes, J., Bareche, J., Pareja-Sánchez, E., Justes, E., Cantero-Martínez, C.	
<b>Session IV: Studies and mitigation options at the farm level – Oral presentations .....</b>	<b>366</b>
Keynote presentation: Sources of nitrogen in cereal production and mitigation options .....	367
Ladha, J.K.	
Do agricultural practices impact carbon, nitrogen and phosphorus stoichiometry in plants and soils on the long-term?.....	369
Ferchaud, F., Mary, B., Keuper, F., Mollier, A., Denoroy, P., Morel, C., Gallet-Budynek, A., Houot, S., Jouany, C., Hedde, M., Hinsinger, P., Jourdan, C., Bertrand, I.	

Identifying NEMO: a model-based methodology to identify strategic N application rates for rainfed crop.....	371
Pattey, E., Mesbah, M., Jego, G.	
Ammonia emission from animal manure and mineral fertilizer measured with a cheap, reliable & simple to use method .....	373
Sommer, S.G., Kure, J.L., Krabben, J., Duelund L., Pedersen, S.V.	
Nitrogen use efficiency as an indicator of farm performance .....	376
Quemada, M., Brentrup, F., Rutkowska, L., Stoumans, L., Schulman, M., Oenema, O.	
Aquaponics system, a solution to limit nutrient release by fish farming?.....	378
Jaeger, C., Foucard, P., Tocqueville, A., Nahon, S., Aubin, J.	
A comparative nitrogen balance of novel cropping systems for feedstock production to future biorefineries: the role of perennial grasses and grass-legumes .....	380
Manevski, K., Lærke, P.E., Jørgensen, U.	
Multi-model assessment of mitigation options for GHG emissions in croplands.....	382
Carozzi, M., Ehrhardt, F., Brilli, L., Bellocchi, G., Bhatia, A., De Antoni Migliorati, M., Doltra, J., Dorich, C., Doro, L., Fitton, N., Grace, P., Grant, B., Giacomini, S.J., Léonard, J., Loubet, B., Massad, R.S., Mula, L., Pattey, E., Sharp, J., Smith, P., Smith, W., Zhang, Q., Recous, S.	
<b>Session IV: Studies and mitigation options at the farm level - Highlighted posters .....</b>	<b>384</b>
Finetuning abatement of ammonia emissions from livestock housing according to impact on protected habitats.....	385
de Pue, D., Bral, A., Buysse, J.	
Nitrate Leaching risk assessment after Incorporation of fertilized catch crops .....	390
de Waele, J., Radam, E.D., de Vliegheer, A., Vandecasteele, B., de Neve, S.	
Nitrous oxide-nitrogen emission factors for a biofuel crop .....	393
Cantarella, H., Carvalho, B.G.O., Lourenço, K., Carvalho, J.L.N., Gonzaga, L.C.; Kuramae, E., Soares, J.R.; Carmo, J.B.	
Illustrative modelling of nitrate leaching from fertiliser and manure nitrogen applications .....	395
Hutchings, N.J., Sørensen, P.	
Nitrogen supply by roller-crimped agro-ecological service crops in organic cabbage production.....	397
Hefner, M., Kristensen, H.L.	
Acidification prior to drying of digestate solids as a bio-based fertiliser affects nitrogen and phosphorus uptake and fertiliser value when applied to maize.....	399
Liu, JN., Müller-Stöver, DS., Jensen, LS.	
A novel platform providing services in the measurement of potentials for ammonia volatilisation ..	401
Genermont, S., Decuq, C., Flura, D., Masson, S., Esnault, B., Autret, H.	
Yield of winter crops with legumes monocropped and intercropped with grasses: effects on a subsequent maize crop in a double cropping system.....	403
Báez, M.D., García, M.I., M. Mella, Gilsanz, C.	
Implications of the cover crop termination date on N and water cycles.....	405
Alonso-Ayuso, M, Quemada, M, Vanclouster, M, Ruiz, M, Rodriguez, A, Gabriel, J.L.,	

Fertilizer strategies to improve NUE in grazed dairy pastures.....	407
Smith, A. P. , Christie, K. C. , Rawnsley, R. P. ,Eckard, R. J.	
Modelling the effect of wide ranging drip irrigation regimes and N-fertigation rates on potato growth and production on a coarse sand.....	409
Motarjemi, S.K., Zhou, Z., Andersen, M.N, Plauborg, F.	
Nitrogen input mapping at the field scale using remotely piloted aircraft systems imagery.....	411
Maire J., Gibson-Poole S., Cowan N., Richards K., Skiba U., Rees R.M., Reay D.S., Lanigan G.	
Manure N plays a dual role in C stabilization and N supply soil functions – evidence from long-term field studies .....	413
Chantigny, M.H., Angers, D.A.	
Carbon and nitrogen sequestration and nitrate leaching mitigation by cover crops .....	415
García-González, I., Hontoria, C., Gabriel, J.L. Alonso-Ayuso, M., Quemada, M.	
Grain yield and nitrogen use efficiency (NUE) response in old and new durum wheat genotypes to different fertilization timing.....	417
Gioacchini, P., Palumbo, M., Sciacca, F., Virzi, N., Allegra, M., Rocuzzo, G. Ciavatta, C.	
Decision rules for environment-friendly wheat N fertilization: combining crop model and viability theory .....	419
Jeuffroy, M.-H., Lenoir, A., Ravier, C., Sabatier, R., Meynard, J.-M.	
Conserving carbon stocks and mitigating nitrous oxide emissions by using a forage crop rotation instead of continuous maize cultivation .....	421
Loges, R., Bunne, I., Hermann, A., Taube, F.	
<b>Session IV: Studies and mitigation options at the farm level Posters.....</b>	<b>423</b>
A spatial framework to facilitate testing and adoption of new technologies.....	424
Grassini, P, Rattalino Edreira, JI, Cassman, KG	
Shade tree species impacts on soil fauna and C, N, P cycles in Costa Rican organic and conventional coffee agroforestry systems.....	427
Sauvadet, M., Van Den Meersche, K., Allinne, C., Gay, F., Virginio Filho, E.De.M., Chauvat, M., Becquer, T., Tixier, P., Harmand, J-M.	
N fertilizer value of legume-based catch crops.....	429
de Notaris, C., Sørensen, P., Rasmussen, J., Olesen, J. E.	
More profit from nitrogen in Australian agriculture.....	431
Smith, A. P. , White, M.	
Benchmarking on-farm N footprint using a simplified N-balance approach .....	433
Tenorio, F.A., Mcllellan, E. , Eagle, A., Grassini, P.	
Effect of feeding the grass fibrous fraction obtained from biorefinery on N and P utilisation of dairy cows.....	436
Pijlman, J., Koopmans, S., De Haan, G., Lenssinck, F. , Van Houwelingen, K.M., Sanders, J.P.M.,Deru, J.G.C., Erisman, J.W.	

Crop residues decomposition dynamics in farms practising conservation agriculture in the Grand Est region, France.....	439
Thiebeau, P., Recous, S.	
An evaluation of nitrogen balances at the whole-farm and field scale on 21 Irish dairy farms .....	441
Murphy, P.M., Murphy, P.N.C., and Wall, D.P.	
UMT ALTER'N: to strengthen the strategic farm advisory for cropping systems based on legume crops or organic fertilisers with low nitrogen losses and low dependency to synthetic fertilisers.....	443
Schneider A., Colnenne-David C., Cadoux S., Drouet J.-L. , Houot S., Jeuffroy M.-H., Le Gall C., Reau R.	
Comparative analysis of some ecosystem services components linked to nitrogen fluxes of cropping systems with grain legumes .....	445
Schneider A., Oddos L., Pelzer E., Jeuffroy M.-H.	
Optimising N-transfer in oilseed rape based crop rotations in Northern Germany .....	448
Rose, M., Pahlmann, I., Kage, H.	
Towards nitrogen self sufficiency in cropping system of chalk soils in Champagne-Ardenne and Picardie (France).....	450
Cros, C., Duparque, A., Reau, R.	
N and S cycles in crucifer-legume cover crop mixtures .....	452
Couédel, A., Alletto, L., Justes, E.	
Autumn soil mineral nitrogen concentration as potential predictor of nitrogen leaching.....	454
Swartz, E., Børgesen, C.D., Blicher-Mathiesen, G., Piil, K., Vinther, F.P., Østergaard, H.S.	
Living cover competition in banana plantation and nitrogen management after a legume cover crop rotation.....	457
Achard, R., Rosalie, E., Dorel M..	
Landscape and national level solutions for a more sustainable N management in Denmark.....	459
Dalgaard, T., Brock, S., Cordovil, C.M.S., Graversgaard, M., Hansen, B., Hashemi, F., Hasler, B., Hutchings, N.J., Jacobsen, B., Jensen, L.S., Kjeldsen, C., Olesen J.E., Schjørring, J.K., Sigsgaard, T., Stubkjær Andersen, P., Termansen, M., Vejre, H., Vestergaard Odgaard, M., Wiborg, I.A.	
Controlled traffic farming increases root growth, crop and soil nitrogen in vegetable cropping systems .....	461
Hefner, M., Labouriau, R., Nørremark, M., Kristensen, H.L.	
Evaluating the potential of dietary crude protein manipulation in reducing ammonia emissions from cattle and pig manure .....	463
Amon, B., E.P.M, Sajeev., Zollitsch, W., Ammon, C., Winiwarter, W.	
Supporting transition to low inputs production systems: economic and environmental assessment	465
Devienne S., Vertes F., Garambois N., Akkal-Corfini N., Durand P., Parnaudeau V.	
Organic N fertilization effects on pasture establishment and forest fire prevention.....	467
Ferreiro-Dominguez N, Rodriguez-Rigueiro J, Rigueiro-Rodriguez A, Mosquera-Losada Mr	
Pasture production in a silvopastoral system established with <i>juglans regia</i> l. and fertilized with sewage sludge .....	469
Mosquera-Losada, M.R., Arias-Martinez, D., Rigueiro-Rodríguez A, Ferreiro-Dominguez, N.	

N<sub>2</sub>O emissions from crop residues vary greatly with residue quality and management..... 471  
Olesen, J.E., Recous, S., Hansen, S., Jensen, E.S., Butterbach-Bahl, K., Rees, R.M., Bleken, M.A., Smith, K.E., Ernfors, M., Laville, P., Lashermes, G., Loubet, B., Massad, R., Petersen, S.O., Thorman, R.E., Taghizadeh-Toosi, A., Topp, C.F.E.

# 20<sup>th</sup> Nitrogen Workshop

## Coupling C-N-P-S cycles

June 25-27, 2018

Le Couvent des Jacobins, Rennes – France

### **Session I: N cycle in landscapes - Oral presentations**

**KEYNOTE PRESENTATION: HOW NITROGEN CHANGED DIFFERENT LANDSCAPES**

ERISMAN J. W.<sup>1</sup>, GALLOWAY J. N.<sup>2</sup>, LEACH A. M.<sup>3</sup>, AND BLEEKER A.<sup>4</sup>

<sup>1</sup>Louis Bolk Institute, Kosterijland 3, 3981 AJ Bunnik, The Netherlands and VU Amsterdam, The Netherlands, [j.w.erisman@vu.nl](mailto:j.w.erisman@vu.nl) <sup>2</sup>University of Virginia, 291 McCormick Rd, Charlottesville, VA 22904, USA <sup>3</sup>University of New Hampshire, Durham, New Hampshire 03824, USA. <sup>4</sup>PBL, Bezuidehouthoutseweg 30, The Hague, The Netherlands.

**ABSTRACT**

For a long time there was enough naturally occurring nitrogen (N) to provide food for the world's peoples. Then we decided to live in settlements and in cities and while the population started to grow nitrogen management became important. Still there was no shortage. Major breakthroughs in nitrogen science was more driven by warfare and market mechanisms than for food. When population increased further nitrogen became limited for our food. With the invention of the chemical fixation of N the scarcity problem was solved. But this transition from enough, to scarcity, to plenty has come with a tremendous environmental cost. It has changed the physical, societal, industrial and economic landscapes in the world.

The history of nitrogen (N) use by people is a field well-fertilized with materials detailing the evolution of knowledge about nitrogen, the development of the Haber-Bosch process and the extent and impact of N cycle alteration by people. This presentation provides an historical overview of the growth of knowledge about N and about its impacts, both positive and negative. It marks the major needs for nitrogen and the accumulation of N knowledge with respect to its benefits (feeding the wars) and its problems (specialization in agriculture and cascading and accumulating N impacts).

By focusing on the major drivers for managing nitrogen in the future we explore different potential solutions of how to feed the world's population while preserving the landscape. Furthermore, we will identify the need for continuous knowledge and technology development.



## REBALANCING NUTRIENT RATIOS IN STREAMS AND RIVERS

WADE, AJ.<sup>1</sup>, STUTTER, M.<sup>2</sup>, JARVIE, HP.<sup>3</sup>, HALLIDAY, SJ.<sup>4</sup>, COOPER, DM.<sup>5</sup>

<sup>1</sup>Department of Geography and Environmental Science, University of Reading, UK; <sup>2</sup> James Hutton Institute, Aberdeen, UK; <sup>3</sup> Centre for Ecology and Hydrology, Wallingford, UK; <sup>4</sup> Department of Geography and Environmental Science, University of Dundee, UK; <sup>5</sup> Centre for Ecology and Hydrology, Bangor, UK.

### INTRODUCTION

Eutrophication of fresh and coastal waters is a widely recognised problem and river-system primary production is known to depend on carbon (C), nitrogen (N) and phosphorus (P), light, temperature and residence time, with other factors becoming limiting under certain conditions such as silicon during diatom blooms (Bowes et al., 2016). A further consideration is that microbial growth and respiration can be limited by organic carbon availability in rivers and there may be potential within the heterotrophic cycling system for stream water N and P removal (Stanley et al. 2012). Whilst a good understanding of the links between the biochemical cycles of C, N and P in freshwaters has been developed through manipulation experiments and single site studies, there has been less focus on C, N and P variation in space and time at the catchment, national and global scales, and how instream inorganic and organic C:N:P ratios relate to catchment sources and within-channel processes including autotrophic and heterotrophic production. This work aims to quantify stream and river C:N:P ratio variation across spatial and temporal scales, comparing and contrasting inorganic and organic stoichiometry and how the re-balancing of each may aid a reduction in river-system eutrophication.

### MATERIAL AND METHODS

#### Catchment scale

Atomic inorganic C:N:P ratios in eight catchments in Great Britain were plotted and related to key catchment characteristics. The catchments represent key land cover types found across Great Britain and the water quality measurements start in 1975 with a samples taken each week or fortnight typically. These data were supplemented by sub-hourly sampling from two catchments over a two year period. This was done to analyse the short-term dynamics to explore instream processing in addition to the flow-related, seasonal and long-term variations using the longer term, less frequent data.

#### National scale

The Centre for Ecology and Hydrology's Countryside Survey (CS) was used to provide a snap shot of water samples (Reactive Phosphorus, Total Oxidised Nitrogen, pH and alkalinity) for 2007 across 591 1 km x 1 km sample squares outside major urban areas. The THINCARB model was used to estimate the dissolved inorganic carbon concentrations from pH, alkalinity and water temperature measurements (Jarvie et al., 2017). A key feature is the study of headwater streams in relation to the lower reaches. The atomic inorganic C:N:P ratios were again related to catchment characteristics and used to determine N and P depletion and the occurrence of N-limited, P-limited and N and P co-limited rivers amongst a broader analysis (Jarvie et al., 2018).

#### Global scale

A global database of DOC and dissolved N and P forms, concentrations and ratios was assembled to describe global catchment nutrient sources and rivers, categorised by climate and land use. A second review assembled global evidence for the bioavailability of dissolved organic C, N and P (DOC, DON, DOP). This was necessary to scale the stoichiometric ratios of the first database to available resources, required to correctly evaluate constraints on microbial metabolism (Stutter et al., 2018).

### RESULTS AND DISCUSSION

### **Catchment and national scales**

The combined results highlight that land use and point source inputs largely determine streamwater C:N:P ratios in Great Britain and, typically, the effect of instream processing on C:N:P concentrations is masked by the C, N and P inputs to the stream network. Stoichiometric P depletion is more commonly seen in lowland rivers, with a greater prevalence of N-limitation, and P and N co-limitation, in headwater streams.

### **Global scale**

Within the context of heterotrophic cycling systems, the atomic ratios of bioavailable C:N and C:P in rivers with urban and agricultural land use were often distant from the 'microbial optimum'. This C-deficiency relative to high availabilities of N and P likely appears to offer opportunity to retain N and P within the microbial biomass by active stoichiometric rebalancing.

### **CONCLUSION**

These studies indicate that, to reduce eutrophication of rivers, prioritisation of P concentration reduction in lowland, high alkalinity catchments and N concentration reduction in upland, low alkalinity catchments appears beneficial. In terms of heterotrophic cycling, alleviating organic-C depletion may lead to greater assimilation of nitrogen and phosphorus into the microbial biomass thereby aiding further reduction in instream N and P concentrations. Increased organic-C could be achieved through the reintegration of wetlands into river systems. Further work is needed to better integrate understanding derived from macro-scale data analysis with the more nuanced assessments of C:N:P interactions at local and short-time scales to provide the evidence on which to base eutrophication management and mitigation approaches on the ground. Of particular importance is development of an integrated understanding of the inorganic and organic C, N and P controls on autotrophic and heterotrophic production across a wide-range of river-system settings. Comparison with studies of C:N:P cycling in soil-vegetation systems may also help develop integrated soil and water strategies to better reduce eutrophication.

**Acknowledgements:** All authors acknowledge funding from the UK Natural Environment Research Council (UK NERC grant numbers: NE/J011908/1; NE/J011991/1; NE/J011967/1 under the Macronutrient Cycles Program) and MS additionally from Scottish Government's Rural Environment Science and Analytical Services, and HPJ from the UK NERC via the Strategic Importance of Headwaters for UK Water Resources project (NEC05966).

### **REFERENCES**

- Bowes MJ., Lowenthal M., Read DS., Hutchins MG., Prudhomme C., Armstrong LK., et al., 2016. Identifying multiple stressor controls on phytoplankton dynamics in the River Thames (UK) using high-frequency water quality data. *Sci. Tot. Environ.*, 434, 201-212.
- Jarvie, HP, King SM, Neal, C., 2017. Inorganic carbon dominates total dissolved carbon concentrations and fluxes in British rivers: Application of the THINCARB model - Thermodynamic modelling of inorganic carbon in freshwaters. *Sci. Tot. Environ.*, 575, 496-512.
- Jarvie HP., Smith DR., Norton LR., Edwards FK., Bowes MJ., King SM., Scarlett P., Davies S., Dils RM., Bachiller-Jareno N. 2018. Phosphorus and nitrogen limitation and impairment of headwater streams relative to rivers in Great Britain: a national perspective on eutrophication. *Sci. Tot. Environ.*, 621, 849-862.
- Stanley EH., Powers S M., Lottig NR, Buffam I., Crawford JT., 2012. Contemporary changes in dissolved organic carbon (DOC) in human-dominated rivers: is there a role for DOC management? *Freshwater Biol.* 57 (suppl. 1), 26-42.
- Stutter M., Evans CD., Graeber D., Wade AJ., Withers PJA., 2018. Stoichiometric rebalancing allows microbial regulation of aquatic nutrient pollution. *Sci. Tot. Environ.*, 634, 439-447.

## **MULTI-DECADAL TRAJECTORY OF RIVERINE NITROGEN, PHOSPHORUS AND CARBON DYNAMICS IN RURAL CATCHMENTS**

DUPAS, R.<sup>1</sup>, MINAUDO, C.<sup>2</sup>, GRUAU, G.<sup>3</sup>, RUIZ, L.<sup>1</sup>, GASCUEL-ODOUX, C.<sup>1</sup>

<sup>1</sup> INRA, UMR1069 SAS, Rennes, France; <sup>2</sup> University Francois Rabelais de Tours, E.A. 6293 GeoHydrosystemes Continentaux, Tours, France; <sup>3</sup> Observatoire des Sciences de l'Univers de Rennes, CNRS, UMR 6118 Geosciences Rennes, Rennes, France

### **INTRODUCTION**

Human activities have substantially altered riverine exports of nitrogen, phosphorus and carbon in the Anthropocene, causing major alterations of freshwater and marine ecosystems worldwide (Steffen et al., 2015). Documenting anthropogenic alterations of nutrient and carbon cycles in aquatic ecosystems is a challenge as industrialization in western countries began in the 18th century and the green revolution in the mid-20th century, while river monitoring became widespread only since the 1990's (Gascuel-Odoux et al., 2010). Brittany - France, is one of the few noticeable exceptions of a region with multi-decadal datasets of nitrate (N-NO<sub>3</sub><sup>-</sup>), soluble reactive phosphorus (SRP), total phosphorus (TP) and dissolved organic carbon (DOC) in meso-scale (< 5000 km<sup>2</sup>) rural catchments.

### **MATERIAL AND METHODS**

Here we analyze these multi-decadal and multi-parameter time series in seven rivers with the objective to investigate: i) long term trajectory of N, P, C concentrations in relation to the history of diffuse and point source pressures since the 1970's (Figure 1), ii) medium term variations in relation to inter-annual climate variability (during 5-year wet-dry cycles) and iii) seasonal variations (and their long term evolution) in relation to catchments properties and history. Statistical analyses include a seasonal-trend decomposition procedure based on Loess (STL), breakpoints detection (BFAST) and long term input-output hysteresis plots.

### **RESULTS AND DISCUSSION**

Results show that long term N-NO<sub>3</sub><sup>-</sup> concentration is controlled by the agricultural N surplus with a hysteresis effect, indicating a time lag of approximately 10 years between decrease in N inputs and decrease in N-NO<sub>3</sub><sup>-</sup> loads. Long term SRP and TP concentrations are mainly controlled by point source emissions that have decreased continuously since the 1980's. Long term DOC concentration shows little variation contrary to many catchments of the northern hemisphere (Monteith et al., 2007). Medium term inter-annual N-NO<sub>3</sub><sup>-</sup> concentration is controlled by discharge, with an increase in concentrations during wet years and a hysteresis effect indicating the flushing of a pool of nitrate stored in the catchments during antecedent drier years (Dupas et al., 2016). Medium term SRP concentration is also controlled by discharge, with a dilution during wet years supporting the hypothesis of point-source dominated emissions. Medium term variations in TP and DOC concentrations are less clear, possibly because of opposite flushing and dilution effects during wet years. Seasonal variations exhibited winter maxima for N-NO<sub>3</sub><sup>-</sup> and summer maxima for SRP, TP and DOC, confirming the dominant diffuse nature of N-NO<sub>3</sub><sup>-</sup> emissions, the point-source dominated P emissions and possibly autochthonous DOC production during the summer period.

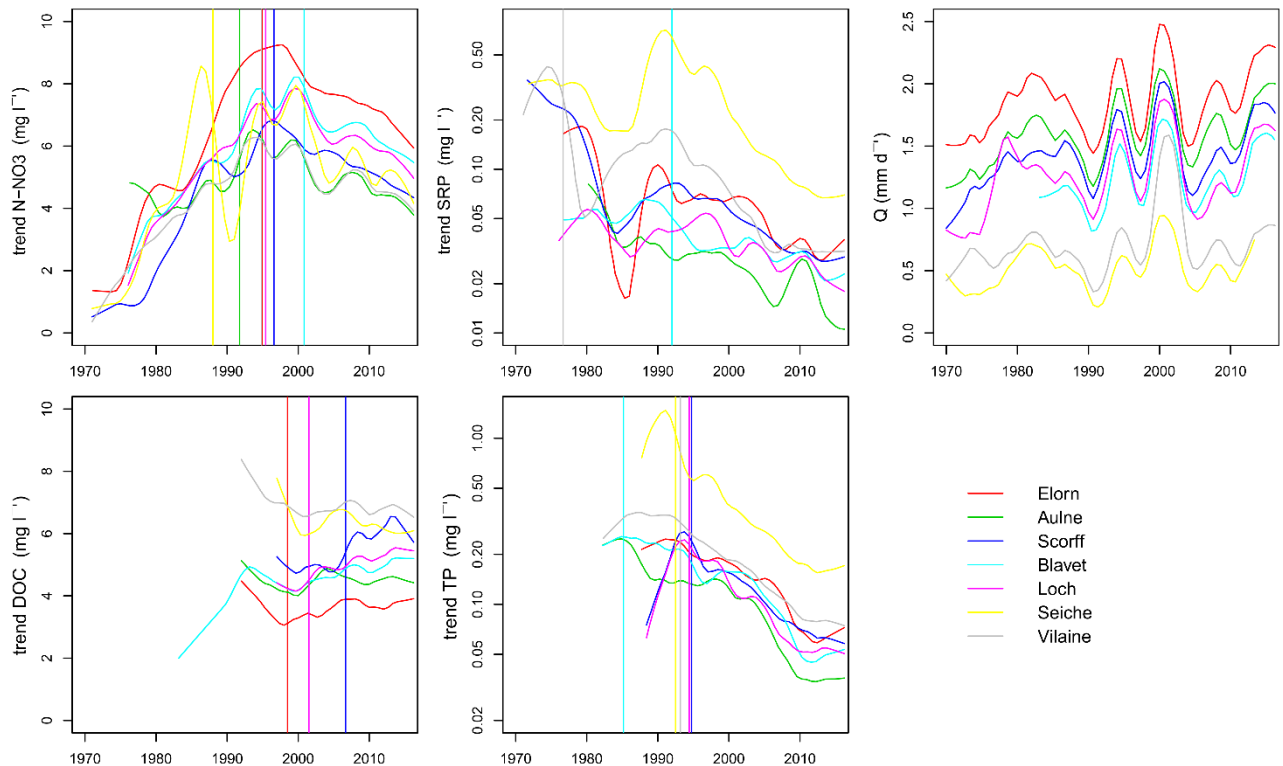

Figure 1: Long term trend of nitrate-N, Soluble Dissolved Organic Carbon (DOC), Soluble Reactive Phosphorus (SRP) and Total Phosphorus (TP) in seven Brittany rivers. Vertical bars indicate BFAST breakpoints.

## CONCLUSION

Results show that multi-decadal N and P trends were mainly driven by N and P diffuse and point sources inputs, respectively, with response times for nitrate being controlled by the amount of legacy N stored in the catchment. At medium term inter-annual time scales, climate variability was the dominant control on concentration variability, which implies that evaluation of water quality mitigation programs should cover at least five years to decipher their effect from the effect of climate variations. Seasonally, N and P dynamics were typical of diffuse and point source dominated exports, respectively, similar to many catchments of the temperate zone. In-stream retention and remobilization processes, however, lead to difficulties in extracting the P land-to-river export signal from in-stream processes in these meso-scale catchments. Dominant controls on differences among catchments can often be inferred from catchment properties, but ambiguity issues (i.e. when the same observation can have several possible origins/interpretations) arose.

## REFERENCES

- Dupas R, S. J, Musolff A, Borchardt D, Rode M. Disentangling the influence of hydroclimatic patterns and agricultural management on river nitrate dynamics from sub-hourly to decadal time scales. *Science of the Total Environment* 2016: 791-800.
- Gascuel-Oudoux C, Aurousseau P, Durand P, Ruiz L, Molenat J. The role of climate on inter-annual variation in stream nitrate fluxes and concentrations. *Science of the Total Environment* 2010; 408: 5657-5666.
- Monteith DT, Stoddard JL, Evans CD, de Wit HA, Forsius M, Hogasen T, et al. Dissolved organic carbon trends resulting from changes in atmospheric deposition chemistry. *Nature* 2007; 450: 537-U9.
- Steffen W, Richardson K, Rockstrom J, Cornell SE, Fetzer I, Bennett EM, et al. Planetary boundaries: Guiding human development on a changing planet. *Science* 2015; 347

## THE ROLE OF COUPLED MACRONUTRIENT CYCLES FOR ECOSYSTEM SERVICE SUPPLY AT THE LANDSCAPE SCALE

REINSCH, S.<sup>1</sup>, BLANES, M.A.<sup>2</sup>, COSBY, B.<sup>1</sup>, GLANVILLE, H.<sup>3,4</sup>, HARMENS, H.<sup>1</sup>, JONES, D.<sup>3</sup>, DE SOSA, L.L.<sup>3</sup>, MARSHAL, M.<sup>1,3</sup>, MERCADO, L.<sup>5</sup>, SMART, S.<sup>1</sup>, WINTERBOURN, J.B.<sup>1</sup>, EMMETT, B.A.<sup>1</sup>

<sup>1</sup> Centre for Ecology and Hydrology, United Kingdom; <sup>2</sup> University of Jaen, Spain; <sup>3</sup> Bangor University, United Kingdom; <sup>4</sup> Keele University, United Kingdom; <sup>5</sup> Exeter University, United Kingdom

### INTRODUCTION

A major research programme in the UK has explored how the coupling of carbon (C), nitrogen (N) and phosphorus (P) within catchments influence the supply of ecosystem services on land, in rivers and across the land-marine interface. Service supply quantified included support of biodiversity, water quality, plant production, and C storage. We focussed our work around the Conwy catchment in North Wales, UK, which has a wide range of climate, topography, soil and land-use types (Emmett et al. 2016). The study approach included routine and campaign co-located soil, water and vegetation sampling, *in-situ* and laboratory manipulation experiments and modelling. Here we present results from the terrestrial C-N-P part of the project addressing the coupling of above-ground (plant) and below-ground (soil) C and nutrient dynamics across land-uses and with depth. We explore C and nutrient constraints on plant photosynthesis (PS), aboveground biomass productivity (aNPP) and soil C turnover.

### MATERIAL AND METHODS

In the Conwy catchment, 17 terrestrial sites were identified covering arable, improved and unimproved grasslands, woodlands and peatlands. At these sites, plant photosynthetic parameters ( $J_{max}$ ,  $V_{cmax}$ ), foliar nutrients and aNPP were measured. Co-located soil chemical (total C, N, P, nitrate, plant-extractable P) and physical properties (bulk density, water content) were measured at 14 of the 17 sites. Soil measurements were carried out in 15 cm increments from 0 to 105 cm soil depth. Four of the 17 sites were chosen to study C-turnover and nutrient constraints in the topsoil (0-15 cm) and subsoil (15-100 cm). Therefore, C, N and P were added to intact soil cores in a multifactorial design. Cores were incubated at 15 °C and soil respiration rates were measured in campaign over two weeks.

### RESULTS AND DISCUSSION

Soil C, N and P stocks varied across the 17 sites. C stocks increased with decreasing land-use intensity (i.e. from arable to peatland), whereas soil N stocks decreased. The soil P stock was high in intensively managed sites and ~10 times lower in less managed sites. The distribution of soil C, N and P throughout the soil profile was different between intensively and less intensive managed sites (Figure 1). Arable and improved grassland showed a gradual change in soil C, N and P, whereas less managed sites showed decreased soil P (unimproved grassland) or decreased N (peatland) availability in the subsoil compared to the topsoil. These differences in soil C and nutrient stocks provide a great opportunity to understand mechanisms behind coupled above- and below-ground C and nutrient dynamics, and their effects on ecosystem service supply.

PS across all land-uses correlated with foliar N, but not with foliar P. PS did not correlate with soil N or P content, but correlated weakly with soil available nitrate and plant available-P. This suggests that plant photosynthetic capacity and foliar nutrient contents are optimized under the prevailing environmental conditions and soil nutrient pools.

aNPP in managed systems was limited by available P. In contrast, aNPP was N and P co-limited in less managed systems (unimproved grassland and peatland). Land-management alleviated N constraints on aNPP, but not P. Across the land-use gradient we also observed a significant relationship between soil nitrate in the topsoil and aNPP ( $R^2=0.93$ ). These results suggest that although PS was not affected

by soil C and nutrient pools, optimized PS (and foliar nutrients) is not the exclusive determinant of aNPP.

Soil C turnover was different in topsoils and subsoils. Topsoils showed P limitation, whereas subsoils were only N limited. In the Topsoils, soil C turnover of intensively managed systems was co-limited by N and P; in less managed systems, N limitation was stronger than P limitation (unimproved grassland) and vice versa (peatland). These results suggest that topsoil N fertilization causes the development of microbial P limitation, which may translate into reduced aNPP.

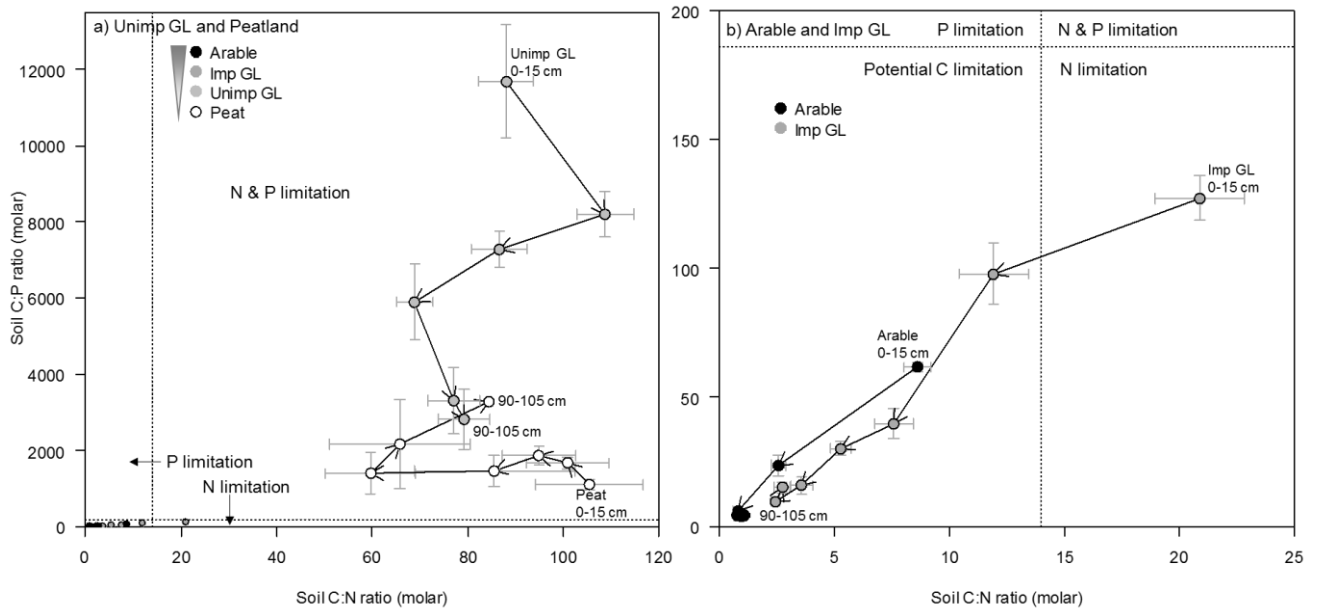

Figure 1: Soil C:N and C:P ratios in the soil profile from topsoil 0-15 cm to subsoil 90-105 cm for a) Unimproved grassland (Unimp GL) and peatland, and b) arable and improved grassland (Imp GL). Dotted lines indicate soil C:N:P ratios of 186:13:1 after Cleveland and Liptzin (2007); resulting squares may be indicators of potential microbial C, N and P limitation.

## CONCLUSION

The complex interplay of C and nutrient cycles, above- and below-ground, support the ecosystem service supply. Land-use may alter C, N and P availability which results in decoupled plant and soil nutrient pools with consequences for aNPP and C-turnover.

**Acknowledgements:** This data was collected for the NERC project 'The Multi-Scale Response of Water quality, Biodiversity and Carbon Sequestration to Coupled Macronutrient Cycling from Source to Sea' (NE/J011991/1). The project is also referred to as Turf2Surf. M.C. Blanes was funded by 'The Agrifood Campus of International Excellence' (ceiA3). Thanks to G. Dos Santos Pereira, E. Gozzard and S. Chesworth for nutrient analyses.

## REFERENCES

- Emmett et al. (2016) Spatial patterns and environmental constraints on ecosystem services at a catchment scale. *Science of the Total Environment* 572: 1586-1600.
- Cleveland and Liptzin (2007) C:N:P stoichiometry in soil: Is there a "Redfield ratio" for the microbial biomass? *Biogeochemistry* 85: 235-252.

## DECADAL TRAJECTORIES OF NITRATE INPUT AND OUTPUT IN THREE CENTRAL GERMAN CATCHMENTS WITH DIFFERING LAND USES

EHRHARDT, S.<sup>1</sup>, MUSOLFF, A.<sup>1</sup>, FLECKENSTEIN, J.H.<sup>1</sup>, ATTINGER, S.<sup>2</sup>, KUMAR, R.<sup>2</sup>,

<sup>1</sup> Department of Hydrogeology, Helmholtz-Centre for Environmental Research – UFZ

<sup>2</sup> Department Computational Hydrosystems, Helmholtz-Centre for Environmental Research – UFZ

### INTRODUCTION

In recent decades anthropogenic activities have doubled the input of nitrogen (N) to the biosphere (Galloway et al. 2004). Consequently, increased riverine concentrations of N (primarily as NO<sub>3</sub>-N) cause exceeded drinking water limits and eutrophication as a global problem. A better knowledge about the fate of N after its agricultural application is indispensable to understand recent and to project future trends of stream NO<sub>3</sub>-N concentrations. This study aims to compare the anthropogenic N-inputs with riverine N-outputs over three decades in three nested catchments with differing land uses. Specifically we pursue two following research questions: Are there considerable time lags between in- and output, and by that a built-up of an N-legacy? And, are the dynamics in the output on decadal and seasonal time scales? The study aims to provide a quantitative input-output assessment through a time-series analysis at both intra- and inter-annual scales; and using this we derive data-driven travel times for subsequent modeling work to project stream solute concentrations.

### MATERIAL AND METHODS

The Holtemme catchment (269 km<sup>2</sup>) is a sub-catchment of the Bode river basin, which is part of the TERENO Harz/Central German Lowland Observatory. This observatory is one of the meteorologically and hydrologically best-instrumented catchments in Central Germany (Zacharias et al. 2011), and provides long-term data for many environmental variables including water quantity (e.g. precipitation, discharge) and water quality at various locations. Three stations were selected to represent the characteristic land use and topographic gradient from the upstream pristine mountainous conditions to intensively agriculturally used lowland downstream conditions near the outlet. Agricultural N-surplus data (as N-input) were compared to biweekly time series (1970 – 2015) of discharge and NO<sub>3</sub> concentrations (as N-output) at the selected locations. The output-analyses were conducted using the EGRET-R-package (Hirsch & De Cicco 2015) to derive flow-weighted daily and annual concentrations.

### RESULTS AND DISCUSSION

The comparison of N-input and -output at the outlet shows a time shift of around ten years regarding measured flow-weighted annual concentration (Fig. 1). Furthermore, the cumulated input of 60.322 t N over six decades faces a riverine output of 7.293 t N. Consequently we hypothesize that the significant storage of 88% N is either removed via denitrification or are still being stored within the terrestrial system as in the soil, groundwater and stream. Evaluating the catchment's potential for removal and storage of N is one of the subsequent tasks.

The seasonal differentiation of concentrations shows the expectable strong seasonality, but as well a changing seasonality over time (Fig. 1). The latter is attributable to vertical N-migration to different aquifer depths over time and their changing contribution to the seasonal discharge. Hence, additionally to the N-output changes on decadal time scales, also seasonal dynamics are abundant. This decadal and seasonal decomposition of the output signal and its explanation by vertical migration enables a better estimation of travel times within the study catchment. The vertical migration of N-input also results in changing C-Q-relationships over the years, evolving systematically from dilution over accretion to chemostatic behavior, which comes along with the observed changes in seasonality.

These new insights into solute transport processes at a catchment scale will be applied in a subsequent modeling work to predict N-solute concentrations.

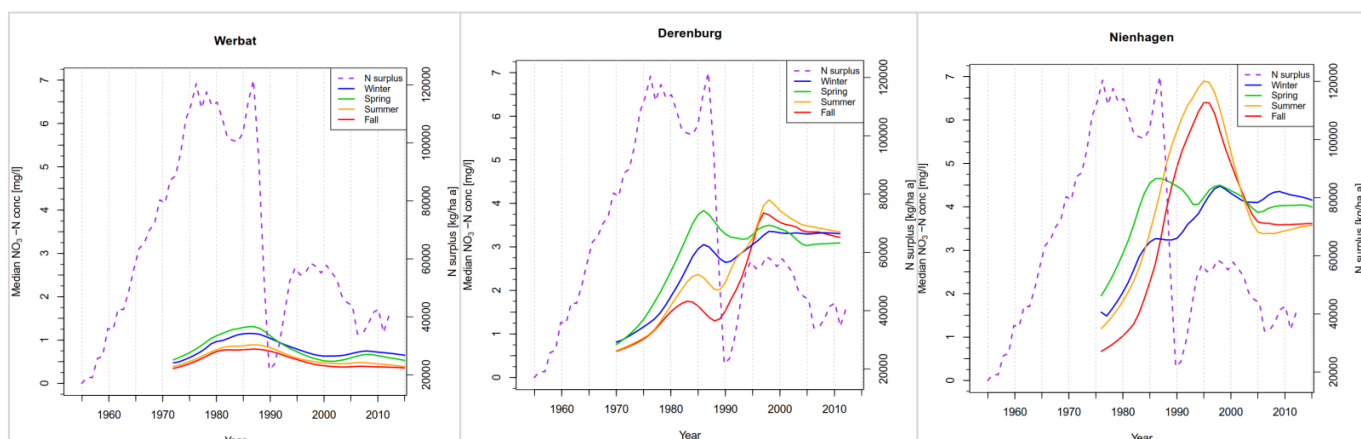

Figure 1. Plot of the annual input of N-Surplus (referred to the whole catchment, 2<sup>nd</sup> y-axis) to the catchment and measured median NO<sub>3</sub>-N concentrations in the stream (1<sup>st</sup> y-axis) over time at three different locations (upstream-Werbat, midstream-Derenburg, downstream-Nienhagen). The colors encode the season (winter-blue, spring-green, orange-summer, red-fall).

## CONCLUSION

The study shows a strong changing chemical behavior over time and space that to a large extent is attributed to the agricultural input history and travel times to the stream, respectively. Hence, excessive anthropogenic N-input has on the one hand a long lasting effect on the catchment as a result of long travel times, and on the other hand a significant impact on the chemical conditions for the riverine ecosystem. Furthermore, up to now, at none of the three investigated stations, the strong decrease in N-input (after 80's) is followed by a comparable time shifted decrease in N-output. These constantly elevated concentrations in concert with the lack of 88% of the N-input account for a high legacy effect of the catchment. Hence, although excessive application of N-surplus is prevented nowadays, the legacy from the last decades will impact the water quality also in the near future. Overall our study underlines the need for long-term management approaches to achieve the goals concerning water quality and to handle global eutrophication problems.

## REFERENCES:

- Galloway J.N., Dentener F.J., Capone D.G., Boyer E.W., Howarth R.W., Seitzinger S.P., Asner G.P., Cleveland C.C., Green P.A., Holland E.A., Karl D.M., Michaels A.F., Porter J.H., Townsend A.R., Vörösmarty C.J. 2004: Nitrogen cycles: Past, present, and future. *Biogeochemistry*, 70, 153–226.
- Hirsch R.M., De Cicco L.A., 2015: User guide to Exploration and Graphics for RivEr Trends (EGRET) and dataRetrieval: R packages for hydrologic data (version 2.0, February 2015): U.S. Geological Survey Techniques and Methods book 4, chap. A10, 93 p., <https://dx.doi.org/10.3133/tm4A10>.
- Zacharias S.S, Bogena H., Samaniego L., Mauder M., Fuß R., Pütz Th., Frenzel M., Schwank M., Baessler C., Butterbach-Bahl K., Bens O., Borg E., Brauer A., Dietrich P., Hajnsek I., Helle G., Kiese R., Kunstmann H., Klotz S., Munch J.C., Papen H., Priesack E., Schmid H.P., Steinbrecher R., Rosenbaum U., Teutsch G., Vereecken H., 2011: A network of terrestrial environmental observatories in Germany. *Vadose Zone J.*, 10, 955–973.



## DISSOLVED ORGANIC MATTER DELIVERED TO AQUATIC ECOSYSTEMS

YATES, C.A.<sup>1</sup>, JOHNES, P.J.<sup>1</sup>, AND THE NERC DOMAINE TEAM

<sup>1</sup>University of Bristol

### INTRODUCTION

The pool of dissolved organic matter (DOM) in aquatic ecosystems is dynamic, consisting of a wide range of compounds with differing chemical structures and reactivities. As a result, DOM has a multifaceted role in the biogeochemistry of aquatic ecosystems. Additionally, in both freshwater and marine systems DOM acts as a major global carbon reservoir (Battin et al., 2008) and is responsible for the delivery of significant quantities of nitrogen (N) and phosphorus (P) to the aquatic environment. This paper presents an analysis of the impact key environmental variables (land cover, modelled soil C:N and stream water nutrient chemistry) have on the concentration and composition of DOM exported to the aquatic environment across a gradient of C, N and P enrichment.

### MATERIAL AND METHODS

Surface water samples were collected weekly, from 47 sampling locations covering a broad range of land use classifications across a gradient of nutrient enrichment over a one-year period (01/10/2015 - 30/09/2016). Samples were collected across a representative range of flow conditions in acid washed (5% HCl) HDPE bottles, filtered on site through 0.45 µm pre-washed cellulose nitrate filters and stored in the dark at 4°C during transport to the University of Bristol for analysis.

#### Carbon, nitrogen and phosphorus analysis

Inorganic nutrient analyses were conducted on a Skalar<sup>++</sup> multi-channel continuous flow autoanalyser set up for simultaneous determination of total oxidised nitrogen (nitrate as NO<sub>3</sub>-N, plus nitrite as NO<sub>2</sub>-N) hereafter referred to as TON, total ammonium (NH<sub>3</sub>-N + NH<sub>4</sub>-N) and soluble reactive phosphorus (SRP, measured as PO<sub>4</sub>-P) analyses. For details see Yates et al., 2016. Organic and particulate N and P fractions were determined by difference following persulphate oxidation. Concentrations of dissolved organic carbon (DOC) were determined by coupled high temperature catalytic oxidation using a Shimadzu TOC-L analyser measured as non-purgable organic carbon following sample acidification. The mean of three to five injections of 150 µl where the coefficient of variance (C.V) for the replicate injections was < 2% is presented here.

#### Absorbance and fluorescence measurements

Absorbance spectra were scanned over the wavelength range 200 - 800 nm at 1 nm intervals and allowed to warm to a constant temperature (20°C) prior to analysis. SUVA<sub>254</sub> values were calculated by dividing the decadic absorbance at 254 nm by DOC concentration (mg l<sup>-1</sup>) (Weishaar et al., 2003) with all absorption data presented in this manuscript expressed as absorption coefficients:  $a(\lambda) = 2.303A(\lambda)/l$ . Where  $a(\lambda)$  is the absorption coefficient in units of reciprocal length (m<sup>-1</sup>),  $A(\lambda)$  is raw absorbance and  $l$  is the cuvette pathlength (m). Spectral slope ( $S$ ) values were calculated using a non-linear fit of an exponential function to the absorption spectrum over the range 350 - 400 nm.

$$a_{\lambda} = a_{\lambda_{ref}} e^{-S(\lambda - \lambda_{ref})}$$

Where  $a$ , is the absorption coefficient,  $\lambda$  = wavelength (nm) and  $\lambda_{ref}$  is a reference wavelength (nm). In addition, fluorescence excitation emission matrices were measured (excitation: 240-450 nm and emission: 300-600 nm) and used to generate proxies for DOM composition (e.g. Fluorescence index; Cory and McKnight, 2005). Statistical analyses were conducted using SPSS<sup>®</sup> Statistical software, version

23 (IBM®), with all plots generated using SigmaPlot version, 13.0 (Systat software). Analysis of absorbance and fluorescence spectra including calculation of spectral slopes and generation of optical indices were conducted using R statistical software. Catchment reach structures and land cover were determined using ArcGIS (Esri) Hydrology toolbox based upon digital elevation models and land cover mapping (LCM 2007). Soil C:N estimates were generated using data provided by the Centre for Ecology and Hydrology (UK) following work conducted by Emmett et al., (2008).

## RESULTS AND DISCUSSION

Mean total N and P concentrations ranged between 0.35 - 9.12 mg N l<sup>-1</sup> and <10 - 380 µg P l<sup>-1</sup> across all sites. Dissolved organic nitrogen (DON) and phosphorus (DOP) concentrations (0.25 - 1.25 mg N l<sup>-1</sup> and <5 - 46 µg P l<sup>-1</sup>) decreased as a % of TN and TP along a gradient of total nutrient concentration (92% - <10% and 70% - <10% respectively) while increasing in absolute concentrations. DOC ranged from 0.77 - 26.2 mg C l<sup>-1</sup> with the highest concentrations observed in catchments dominated by high % bog land cover, and the lowest concentrations observed in arable dominated, groundwater fed systems (Figure 1a). Instream DOC:DON ratio was shown to be a good predictor of SUVA<sub>254</sub> a common proxy for DOM aromatic content in aquatic systems (Weishaar et al., 2003) across a gradient of increasing modelled soil C:N (Figure 1b).

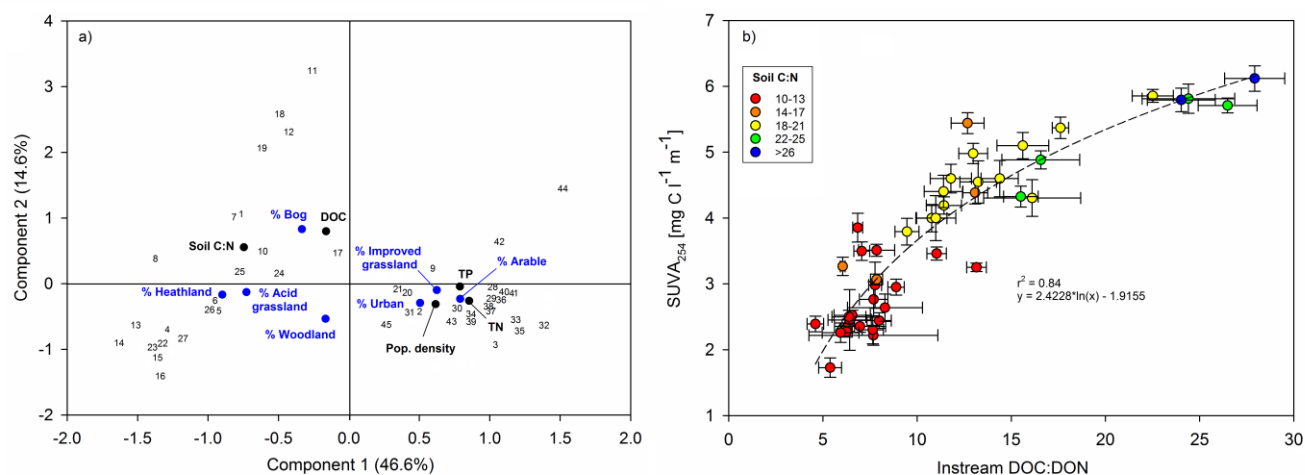

Figure 1. (a) Correlation bi-plot PCA showing sites (numbers) relative to key environmental variables and (b) relationship between instream DOC:DON and SUVA<sub>254</sub> across a gradient of soil C:N (mean values ± SEM).

## CONCLUSION

Overall, differences observed across this gradient of land cover and nutrient enrichment status demonstrate the importance of landscape scale characteristics in the delivery of DOM to aquatic systems. Soil C:N plays an important role in the delivery of DOM to aquatic systems and impacts on the quality and composition of this material, which in turn will have implications for instream communities, catchment C, N and P budgets and efforts to reduce nutrient loading to freshwaters.

**Acknowledgements:** This work was carried out under the DOMAINE Project (NERC Large Grant NE/K010689/1).

## REFERENCES

- Battin TJ, Kaplan LA, Findlay S, Hopkinson CS, Marti E, Packman AI, Newbold D, Sabater F. (2008). Biophysical controls on organic carbon fluxes in fluvial networks. *Nature Geoscience* 2008; 1: 95-100.
- Cory RM, McKnight DM. Fluorescence spectroscopy reveals ubiquitous presence of oxidised and reduced quinones in dissolved organic matter. *Environmental Science & Technology* 2005; 39: 8142-8149.

- Emmett BA, Frogbrook ZL, Chamberlain PM, Griffiths R, Pickup R, Poskitt J, Reynolds B, Rowe E, Rowland P, Spurgeon D, Wilson J, Wood CM. (2008). Countryside Survey Technical Report No.03/07: Soils Manual. Centre for Ecology & Hydrology.
- Weishaar JL, Aiken GR, Bergamaschi BA, Fram MS, Fujii R, Mopper K. Evaluation of specific ultraviolet absorbance as an indicator of the chemical composition and reactivity of dissolved organic carbon. *Env. Sci & Tech* 2003; 37: 4702-4708.
- Yates CA, Johnes PJ, Spencer RGM. Assessing the drivers of dissolved organic matter export from two contrasting lowland catchments, UK. *Science of the Total Environment*, 2016; 569-570, 1330-1340.

## EXPLORING THE SPATIAL VARIABILITY OF N<sub>2</sub>O EMISSIONS FROM A GRAZED UPLAND AND LOWLAND SITE

CARDENAS, L.M.<sup>1</sup>, CHARTERIS, A.F.<sup>1</sup>, HARRIS, P.<sup>1</sup>, MARSDEN, K.A.<sup>2</sup>, HARRIS, I.<sup>2</sup>, GUO, Z.<sup>1</sup>, BEAUMONT, D.A.<sup>1</sup>, TAYLOR, H.<sup>1</sup>, SANFRATELLO, G.<sup>2,3</sup>, JONES, D.L.<sup>2</sup>, WHELAN, M.J.<sup>4</sup>, CHADWICK, D.R.<sup>2</sup>

<sup>1</sup> Rothamsted Research, North Wyke, Okehampton, Devon, EX20 2SB, UK; <sup>2</sup> School of Environment, Natural Resources and Geography, Bangor University, Bangor, Gwynedd, LL57 2UW, UK; <sup>3</sup> Institute of Biological and Environmental and Rural Sciences (IBERS), Aberystwyth University, Aberystwyth, Ceredigion, SY23 3DD, UK; <sup>4</sup> Department of Geography, University of Leicester, Leicester, LE1 7RH, UK.

### INTRODUCTION

Almost 25% of the Earth's land area is used for livestock grazing (Klein Goldewijk et al., 2017) and these ecosystems play an important role in global biogeochemical cycling. In the UK, grazing land occupies over 12 Mha (ONS, 2016), spanning improved lowland and unimproved upland pastures. These systems are managed to varying extents, under contrasting environmental and climatic conditions, with diverse forages, and result in differing degrees of environmental impact. The agricultural sector was responsible for 69% of total UK nitrous oxide (N<sub>2</sub>O) emissions in 2015, produced mainly by microbial nitrogen (N) cycling in soils and the management of livestock manures (Brown et al., 2017). Improved understanding of the spatial and temporal variability of N<sub>2</sub>O emissions from different grasslands will assist with the development of better aggregated emission estimates for different agro-climatic zones and management strategies. In this study, we explore spatial patterns of N<sub>2</sub>O emission with respect to soil and topographic characteristics of contrasting upland and lowland sheep-grazed pastures.

### MATERIAL AND METHODS

#### Sites, sampling and sample analyses

Gas and soil sampling campaigns were conducted over two sites: an 11.5 ha semi-improved, upland pasture (240-340 m above sea level) at the Henfaes Research Station, Abergwyngregyn, North Wales, and a 1.78 ha improved, lowland permanent pasture on the North Wyke Farm Platform, Rothamsted Research, Devon. At the upland site, 112 sampling points were identified on a regular 30 m grid. At the lowland site, a 25 m grid combined with an offset 15 m grid was used to give 99 sampling points, where the offset was chosen to capture small-scale spatial variation. Soil headspace sampling was conducted manually using airtight chambers, subsequently soil temperature was measured and soil samples (0-5 or 0-10 cm) collected from within the chamber area. The upland site has a strong east to west gradient, whilst the lowland site has slopes south to north. Soil headspace N<sub>2</sub>O concentrations were determined by gas chromatography-electron capture detection (GC-ECD). Soil moisture content, bulk density, pH, electrical conductivity (EC), total carbon and N content (%TC and %TN), organic matter (OM) and extractable ammonium (NH<sub>4</sub><sup>+</sup>) and nitrate (NO<sub>3</sub><sup>-</sup>) concentrations were determined.

#### Data processing and statistical analysis

In the first instance, the N<sub>2</sub>O data were investigated for spatial dependence via variograms and, provided a reasonable spatial structure was observed, the N<sub>2</sub>O data were kriged to provide a N<sub>2</sub>O response surface. Second, N<sub>2</sub>O linear regressions with and without spatial effects (in the error term) were assessed. The following N<sub>2</sub>O predictors were investigated: soil %TC, %TN, C:N ratio, extractable NO<sub>3</sub><sup>-</sup>-N and NH<sub>4</sub><sup>+</sup>-N, and total inorganic N concentrations, pH, soil moisture, bulk density, percentage water filled pore space (% WFPS) and OM content; Eastings, Northings, aspect, slope, elevation, compound topographic index; and vegetation type (for upland site only); and inorganic fertilisation (for lowland site only). For instances of non-normality, the data were Box-Cox transformed.

### RESULTS AND DISCUSSION

The variogram of N<sub>2</sub>O emissions at the upland site showed little spatial structure (Fig. 1a). This suggested that either the N<sub>2</sub>O fluxes were randomly distributed or the sample design resolution was too coarse, (i.e. N<sub>2</sub>O spatial dependencies may occur at scales below 30 m). Given the ‘flat’ variogram and high nugget variance, data were not kriged (Fig. 1c). High N<sub>2</sub>O fluxes were only observed at very few sampling points. Conversely, the N<sub>2</sub>O variogram at the lowland site displayed clear spatial structure (Fig. 1b), so kriging was conducted (Fig. 1d). Nitrous oxide fluxes were highest in an east-west band across the lowland field. In both cases, the results of the regression analyses indicated significant soil predictors whilst topographic predictors were not significant. For the upland site, soil %TC, %TN, NO<sub>3</sub><sup>-</sup>-N, and vegetation type were significant; and for the lowland site, soil moisture was the only significant predictor ( $p < 0.05$ ). The predictive fit of the upland regression was stronger ( $R^2 = 0.60$ ) than that found for the lowland ( $R^2 = 0.32$ ). The importance of spatial effects was captured by a significant lowering of the Akaike Information Criterion (AIC) from a regression without spatial effects to one with. Only the lowland site benefitted from spatial regression fit in this respect, as AIC reduced by 5 units.

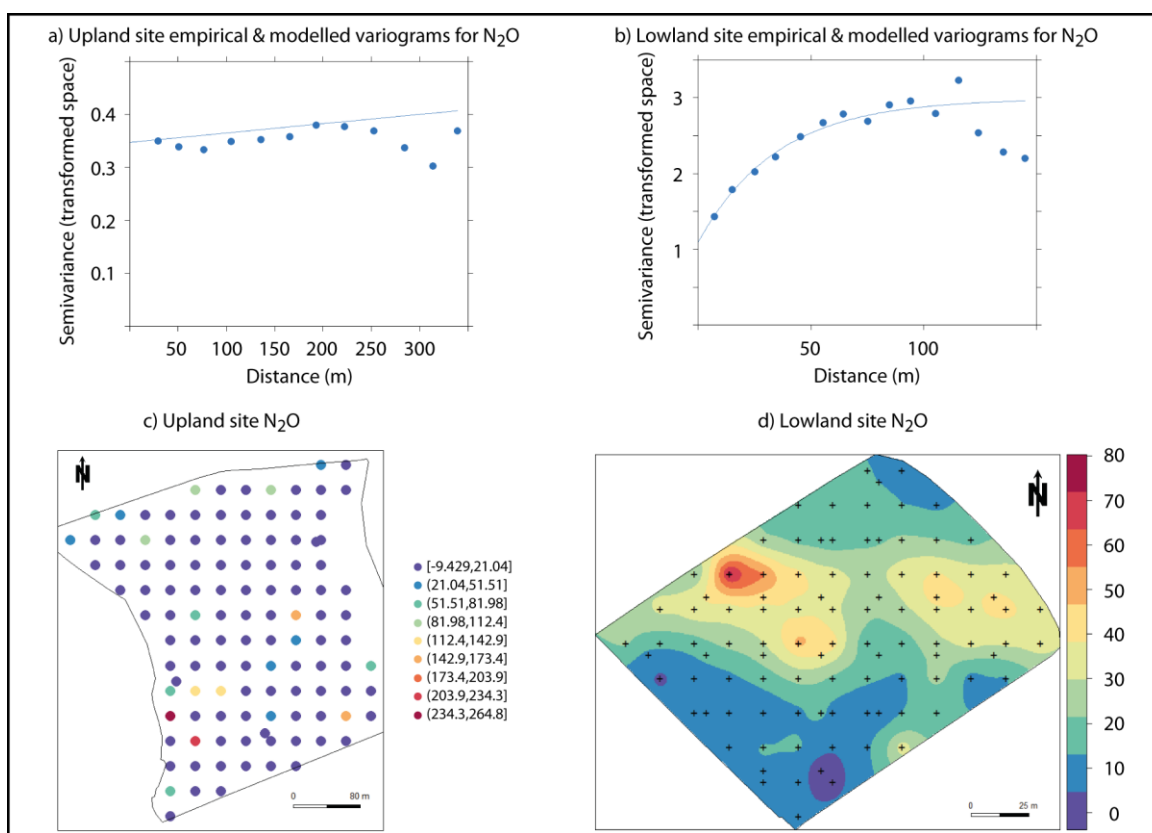

Figure 1. Empirical and modelled variograms: a) upland and b) lowland, and maps: c) upland and d) lowland of N<sub>2</sub>O.

## CONCLUSION

Our results suggest that N<sub>2</sub>O fluxes are controlled by different factors at each site, but work is on-going to better characterise the nature of the interactions amongst these factors and the true extent of spatial heterogeneity. This will enable a better informed, site-specific strategy for the imposition of mitigation measures to reduce N<sub>2</sub>O emissions.

**Acknowledgements:** Thanks to J.A. Holmberg, N.G. Williams, S. Rowlands, L. Greenfield, M. McMahon, D. Arnott, J. Liang, Y. Zhang and X. Wang for help with sample collection and processing. This work was funded by NERC UK, grant award NE/M015351/1/, BBSRC grant award BBS/E/C/000I0320 and the National Capability ‘The North Wyke Farm Platform grant award’ BB/J004308/1. Rothamsted Research is sponsored by BBSRC UK.

**REFERENCES**

- Brown P., Broomfield M., Cardenas L., Choudrie S., Kilroy E., Jones L., Passant N., Thomson A., Wakeling D., 2017. UK Greenhouse Gas Inventory, 1990 to 2015: Annual Report for submission under the Framework Convention on Climate Change. Didcot, Ricardo-AEA.
- Klein Goldewijk K., Beusen A., Doelman J., Stehfest E., 2017. Anthropogenic land use estimates for the Holocene – HYDE 3.2. *Earth Syst. Sci. Data*, 9, 927-953.
- Office for National Statistics, 2016. UK Natural Capital: Ecosystem accounts for farmland (Experimental Statistics)

## SPATIALLY DIFFERENTIATED SCENARIOS TO REDUCE AGRICULTURAL NITROGEN EMISSIONS

HASHEMI F.<sup>1</sup>, OLESEN J.E.<sup>1</sup>, DALGAARD T.<sup>1</sup>, BØRGESEN C.D.<sup>1</sup>

<sup>1</sup> Department of Agroecology, Aarhus University, Blichers Allé 20, 8830 Tjele, Denmark

### INTRODUCTION

Denmark is one of the largest contributors of agricultural nitrogen (N) discharges to the Baltic Sea measured in terms of N-load per hectare. Many N mitigation measures have already been implemented in Denmark since the 1980s, but this has been insufficient to meet the environmental objectives without adversely affecting agricultural production. To this end, a combination of innovative methods to reduce discharges to recipient waters is needed. One such innovative strategy is spatially differentiated N mitigation in agriculture to replace the currently uniform regulation in Denmark and to exploit the fact that there is significant spatial variation in natural groundwater and surface water N-reduction (removal by biogeochemical processes or sedimentation).

### MATERIAL AND METHODS

A review of 130 published articles was carried out with scenario-based modelling of methods for reducing the nutrient load to the aquatic environment (Hashemi et al., 2016). Based on this overview, new methods developed for scenario analysis in two Danish catchments (Norsminde and Odense) based on spatially differentiated aspects of groundwater N-reduction considering spatial constraints (farm boundary and soil type) and two different scales for N-reduction maps (Hashemi et al., 2018a). Ten scenarios were defined using cover crops within the crop rotation, set-aside on high N-load areas and N-leaching relocation based on spatial variation in N-reduction to reach N-load reduction targets of 20% or 40%. Furthermore, the potential of farm-scale measures versus landscape measures for reducing N-loads was investigated in the Odense catchment through a combination of farm and landscape measures to reach the required N-load reduction target of 38% (Hashemi et al., 2018c). This resulted in 17 scenarios by reducing N-leaching at farm (changing to crop rotation and application of cover crops) and landscape scales (set-aside application on high N-load areas) and enhancing N-reduction at landscape scale (wetlands). Scenario analyses were performed using a map-based N-load model to achieve N-load reduction targets with least effect on agricultural production. Using information on variation in groundwater N-reduction maps for construction of spatially differentiated scenarios in the Norsminde catchment provided a basis for exploring the uncertainty in the estimated results (Hashemi et al., 2018b). To reduce the uncertainty in the estimated N-load reductions, three different methods for targeting the set-aside were developed. These methods included application of set-aside based on each individual N-reduction map compared to a mean of 15 randomly chosen N-reduction maps, using the spatial frequency of high N-load and using the spatial frequency of low N-reduction. The efficiency of using different methods was compared in terms of set-aside area required for a 50 or 80% probability of achieving the 20% N-load reduction.

### RESULTS AND DISCUSSION

The scenario analysis showed that the highest reduction in catchment N-load and in set-aside area were achieved where there was the least constraint for N-leaching relocation. The greatest reductions in N-load and set-aside for the spatially differentiated method were achieved using the high-resolution rather than the low-resolution N-reduction maps. The results also showed that a combination of land use, soil type, spatial variation in N-reduction and cropping conditions within each catchment affect the reduction in excessive N-loadings and required set-aside area. Using a combination of measures showed that it was possible to achieve the N-load reduction target without need for set-aside. The potential gain of farm-scale measures was affected by farm type, soil type and the N-reductions possible, while the feasibility of using wetlands to reduce N-load depends on the availability of landscape features that can be used for the establishment of wetlands. In relation to uncertainty

analysis, the results showed that that using ensembles of N-reduction maps rather than individual N-reduction maps could improve the efficiency of spatially differentiated strategies. Using a frequency map of high N-load areas compared to set-aside maps based on average N-reduction map and a spatial frequency of low N-reduction is more effective in terms of N-load and set-aside reduction.

## CONCLUSION

It was found that spatially differentiated strategies for N reduction and using combination of measures can significantly reduce the N load with low impact on agricultural production, and this potential gain varies considerably between catchments, depending on spatial variation in groundwater N reduction and land use. However, the potential benefit of the N-load reduction strategies resulting from a combination of measures at both farm and landscape scale is limited by farm type and the potential area available for the application of measures. In addition, it will be difficult to exploit the full potential in practice due to the current agricultural structure and the uncertainty associated with higher resolution of groundwater N-reduction maps. Despite the higher uncertainty of estimated N-load reductions based on fine-scale compared to coarse-scale N-reduction maps, we suggest using grid-scale N-reduction maps for spatially differentiated strategies since the benefits in terms of the smaller set-aside area required at this scale outweighs the higher uncertainty. Developing new methods for reducing the uncertainty in the estimated results of N-load reductions showed the benefit of using a frequency of high N-load areas for targeting set-aside compared to the other two methods.

**Acknowledgements:** This work was carried out in the BONUS SOILS2SEA project ([www.Soils2Sea.eu](http://www.Soils2Sea.eu)), which received funding from BONUS (Art 185), funded jointly by the EU and Innovation Fund Denmark, The Swedish Environmental Protection Agency, The Polish National Centre for Research and Development, The German Ministry for Education and Research, and The Russian Foundation for Basic Research (RFBR). This study was further supported by The NitroPortugal Project and the Innovation Fund Denmark (contract number 0603- 00517B) through the dNmark Research Alliance (<http://dnmark.org>) supported by the Danish Council for Strategic Research (Ref. 12-132421).

## REFERENCES

- Review of scenario analyses to reduce agricultural nitrogen and phosphorus loading to the aquatic environment. Hashemi, F., Olesen, J. E., Dalgaard, T., & Børgesen, C. D. *Science of the Total Environment*, 2016. 573, 608-626.
- Spatially differentiated strategies for reducing nitrate loads from agriculture in two Danish catchments. Hashemi, F., Olesen, J. E., Hansen, A. L., Børgesen, C. D., & Dalgaard, T. *Journal of environmental management*, 2018a. 208, 77-91.
- Reducing uncertainty of estimated nitrogen load reductions to aquatic systems through spatially targeting agricultural mitigation measures using groundwater nitrogen reduction. Hashemi, F., Olesen, J. E., Jabloun, M., & Hansen, A. L. *Journal of environmental management special Issues*, 2018b.218, 451–464.
- Potential benefits of farm scale measures versus landscape measures for reducing nitrate loads in a Danish catchment. Hashemi, F., Olesen, J. E., Børgesen, C. D., Tornbjerg, H., Thodsen, H., & Dalgaard, T. *Science of the Total Environment*, 2018c.637-638, 318-335.



# 20<sup>th</sup> Nitrogen Workshop

## Coupling C-N-P-S cycles

June 25-27, 2018

Le Couvent des Jacobins, Rennes – France

### **Session I: N cycle in landscapes - Highlighted posters**

## BETTER UNDERSTANDING NITRATE SOURCES AND SINKS IN AGRICULTURAL WATERSHEDS

XIA, YONGQIU<sup>1</sup>, WELLER DONALD E<sup>2</sup>, YAN XIAOYUAN<sup>1</sup>

<sup>1</sup> Key Laboratory of Soil and Sustainable Agriculture, Institute of Soil Science, Chinese Academy of Sciences, Nanjing, 210008, China;

<sup>2</sup> Smithsonian Environmental Research Center, P.O. Box 28, 647 Contees Wharf Road, Edgewater, MD 21037-0028, USA

### INTRODUCTION

Nitrate sources and sinks in agricultural watersheds are poorly understood because of the complexity of N pathways. Human activities have greatly increased nitrogen loading to surface waters resulting from fertiliser human and animal waste applications to agricultural land, and burning of fossil fuels. With the increasing amounts of N loading, biotic N demand can become exceeded, potentially resulting in excess N delivered to surface waters from land-based sources in the watershed. The resulting N exports from aquatic systems is poorly quantified as terrestrial and instream retention can temporarily or permanently reduce downstream transport of nitrogen through physical, biological, or chemical processes.

The export coefficient model is an attractive tool due to its flexibility to incorporate processes and minimum data requirements. However, this method does not account for the extensive variability in space and time because of the great variability of land characteristics, weather, and management practices. This weakness potentially results in two most important uncertainties: structural and parameter uncertainty. Structural uncertainty is defined here as the difference between the true outputs and the model output using lumped and simplified representation of coefficient model. Parameter uncertainty is difference between true parameters and output parameters, reflecting the inability to specify exact values of model parameters due to finite length and uncertainties in the calibration data, imperfect process understanding, model approximation, etc., and showing high sensitivity in space and time.

### MATERIAL AND METHODS

We selected the Qinhuai River watersheds as a case study because they have different proportions of agricultural and non-agricultural land, varied hydraulic residence time, no sewage outfalls, reservoirs, or lakes. A mixed linear model was first used to test the effects of land use and rainfall on water quality. We included the percentages of the impervious surface, dry land, paddy fields, and water categories because the former three are potential sources of N, while the latter is a potential sink for N.

To better quantify nitrate sources and sinks in agricultural watersheds, three improved candidate formulations were developed and compared using a flexible Bayesian framework to explore and quantify the uncertainties of model parameters, to determine their correlation structure, and to use the calibrated model to predict stream nitrate concentration dynamics. The first statistical formulation explicitly assumes that the simulation errors mainly come from the imperfect model structure, and temporal and spatial viability terms should be included to account for the discrepancy between the simulation and the observation. The second statistical formulation explicitly recognizes that the simulation errors mainly come from the static parameters, and parameters should vary temporally and spatially based on the prior distribution. The third formulation is identical to the assumption of model 3, but now allows the parameter distributions to vary temporally and spatially with the input conditions.

### RESULTS AND DISCUSSION

A study over three successive years was conducted to examine the spatial and temporal variations of nutrient concentrations in a paddy agricultural–urban gradient watershed in southeast China. The

results showed that monthly average nutrient concentrations in the river were much higher in the dry seasons of spring and winter than those in the rainy seasons of summer and autumn. The increases in nutrient concentrations with the increase in the proportion of impervious surfaces in the watershed probably results from anthropogenic inputs of fertilizer. We constructed a statistical model to link the variation of nutrient concentrations to land uses and rainfall in the paddy agricultural–urban gradient watershed, and the model predictions from leave-one-out cross-validation provided satisfactory estimates of the contribution of nutrients from different land cover types for the study of the watershed. In terms of the average nitrate concentration of  $2.83 \text{ mg N L}^{-1}$  in the studied river, impervious land contributed the largest amount at  $1.45 \text{ mg N L}^{-1}$ , followed by paddies ( $0.58 \text{ mg N L}^{-1}$ ), while water bodies removed  $0.89 \text{ mg N L}^{-1}$ .

Model skill is assessed by examining the plots of observed versus predicted values, and determining the percent of the observation variance explained by the predictions. The original mixed linear model has poor explanations of observation with an  $R^2$  value of 61%. Strategy 1 explains the majority of the variability ( $R^2=0.77$ ), and the 95% prediction range captures most of the observations. However, strategy 2 and strategy 3 results were strongly correlated with the observation data, with  $R^2$  value of 0.97 and 0.99, respectively. Observations fall in all the intervals of the 95% prediction. Compared to strategy 2, The 95% prediction range of strategy 3 is much narrower and the plot of strategy 3 is more close to 1:1 line (with coefficient of 0.9501 in strategy 3 vs. 0.8672 in strategy 2) and has smaller interception. Therefore, the preferred strategy 3 is used to present spatial and temporal series of posterior values of river nitrate sources and sinks (Fig.1).

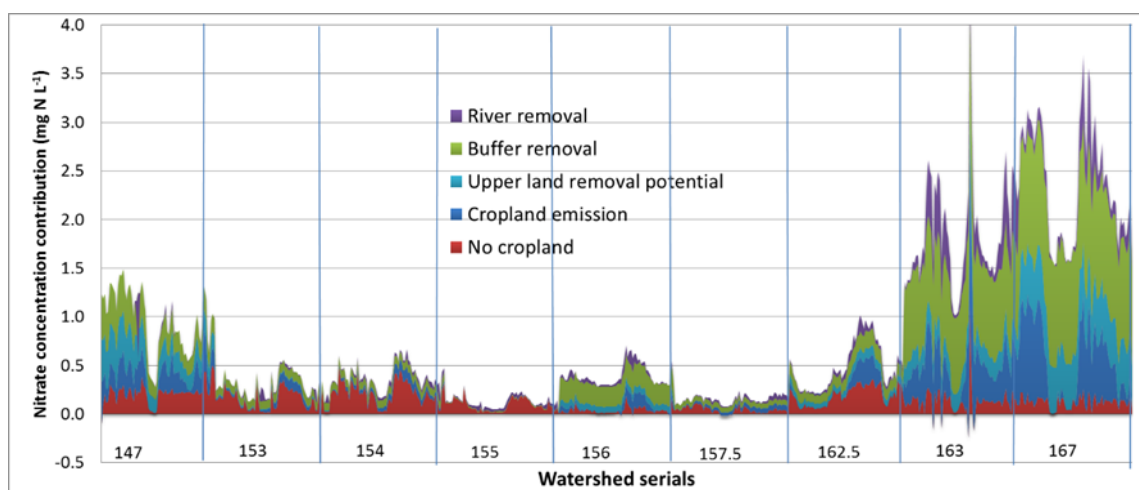

Fig.1 Spatial and temporal variations of the components of predicted nitrate sources and sinks

## CONCLUSION

To better quantify nitrate sources and sinks in agricultural watersheds, we examined three popular methodologies of export coefficient models based on a Bayesian hierarchical framework along with Markov Chain Monte Carlo (MCMC) simulations. Strategy 1 improved the model predictive capacity by the addition of structure and unstructured error terms, but the resulting structural model errors do not give clear ideas about the dynamic parameter values. While strategy 2 included the variability of parameters, it showed low efficiency and much of the error variability. The inclusion of time and space varying parameters in strategy 3 is found to have high predictive skill, realistic uncertainty quantification, and reasonable complexity, provides a promising framework for quantifying nitrate sources and sinks. By parameterizing the spatial and temporal variability of coefficients, we believe that the framework of strategy 3 can meaningfully assist watershed nutrient management.

## IDENTIFICATION OF KEY ATMOSPHERIC N SOURCES AT DESIGNATED SITES - A CASE STUDY FOR SPECIAL AREAS OF CONSERVATION IN NORTHERN IRELAND

CARNELL, E.J.<sup>1</sup>, DORE, A.J.<sup>1</sup>, MISSELBROOK, T.H.<sup>2</sup>, SUTTON M.A.<sup>1</sup> & DRAGOSITS, U.<sup>1</sup>

<sup>1</sup> Centre for Ecology & Hydrology, Edinburgh, UK; <sup>2</sup> Rothamsted Research, North Wyke, UK

### INTRODUCTION

The effects of atmospheric nitrogen (N) deposition are evident in terrestrial ecosystems worldwide, with eutrophication and acidification leading to significant changes in species composition. In the UK, 62% of sensitive habitats are estimated to receive N input in excess of critical loads (2012-14 data). Substantial reductions in N deposition from nitrogen oxides (NO<sub>x</sub>) emissions have been achieved in recent decades. By contrast, UK ammonia (NH<sub>3</sub>) emissions from agriculture have not decreased substantially and are typically highly spatially variable, potentially making efficient mitigation more challenging. Current exceedance levels mean that the UK will struggle to meet national and international biodiversity commitments, in particular for sites designated under the Habitats Directive. The work here presents an approach for identifying the main atmospheric N sources contributing to elevated NH<sub>3</sub> concentrations and N deposition at sensitive sites (adapted from Dragosits *et al.* 2015 and Carnell *et al.* 2017). The approach has been applied to all Special Areas of Conservation (SACs) in Northern Ireland (NI), but the approach is generally applicable to other regions and natural habitat designations. Ammonia concentrations throughout NI are estimated to exceed >1 µg m<sup>-3</sup> and therefore exceed the critical level for lichens, mosses and other lower plants. Approximately 50 % of the area of NI has NH<sub>3</sub> concentrations above 3 µg m<sup>-3</sup>, which is in exceedance of the critical level for higher-plants. In addition to the national scale analysis, five sites were also assessed in more detail using a local database to supplement the national assessment.

### MATERIAL AND METHODS

The main emission sources contributing to N deposition at each SAC were estimated using modelled source attribution data. Source attribution data are derived by performing multiple model runs of an atmospheric transport and deposition model, with each source type removed in turn. N deposition attributed to individual emission source categories (such as agriculture, road transport etc.) or individual large point sources (such as power stations) can then be calculated as a proportion of total deposition to each model grid square. Using these data it is possible to estimate the main contributors to the total N deposition at each designated site.

Agricultural NH<sub>3</sub> emissions were also estimated for a 2 km area surrounding each of the designated sites, using 2015 agricultural census data. Buffer zones around SACs were created to estimate the agricultural NH<sub>3</sub> emission density for the immediate area surrounding the SACs, indicating the average intensity of the N-emitting agricultural activities, and to determine all major agricultural sectors contributing to emissions within these zones. UK average NH<sub>3</sub> emission factors (EFs) from the agricultural emission inventory (Misselbrook *et al.*, 2015) were applied at the holding level data to estimate emission densities surrounding each SAC.

### RESULTS AND DISCUSSION

The analysis of the UK source attribution dataset for SACs in Northern Ireland shows that diffuse agricultural activities pose a significant threat to most sites in Northern Ireland. On average, agriculture contributes ~59 % of total N deposition (to low-growing semi-natural features) received by SACs, and contributes ~90 % of the N deposition from locally depositing species. A substantial proportion of SACs in NI are estimated to be subject to high concentrations of agricultural NH<sub>3</sub> from emission sources close to their site boundary. The dominant emission source of NH<sub>3</sub> (i.e. the largest contribution to estimated NH<sub>3</sub> emissions within the 2 km (or larger) buffer zone) for most SACs is cattle farming (~73 %), and in

particular activities associated with beef farming (Figure 1). The refined methodology applied to the five example sites enabled a reliable distinction of the main threats from atmospheric N (e.g. diffuse agriculture, point sources, roads, etc.) to sensitive habitats and species.

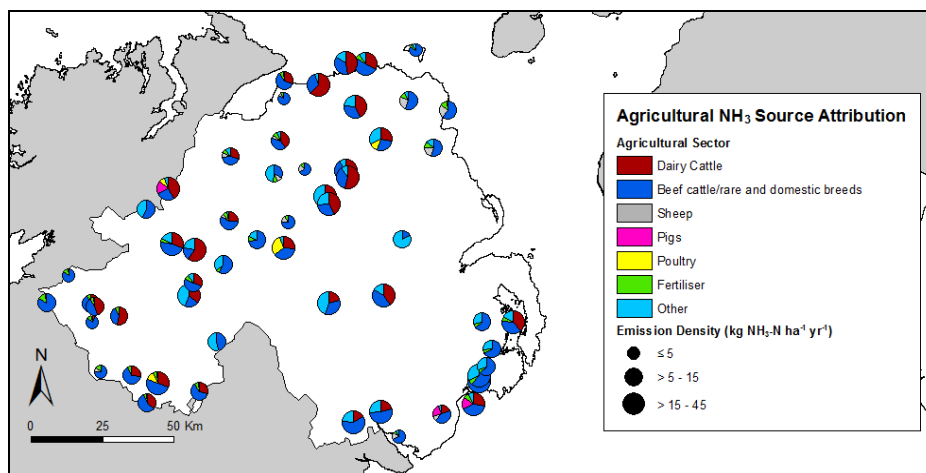

**Figure 1** – Estimated contributions from main agricultural sectors to emissions in areas immediately surrounding SACs in Northern Ireland, which have terrestrial designated features (56 sites). The size of each pie chart is proportional to the estimated local  $\text{NH}_3$  emission density surrounding each site (< 2 km where data licensing conditions are met, and up to 5 km in extensive agricultural regions). The category ‘other’ refers to fertiliser emissions and all livestock sectors which are disclosive (i.e. data points from less than five agricultural holdings) or a category that contributes less than 5% of the total.

## CONCLUSION

The biggest threat to Northern Ireland’s SACs is estimated to come from diffuse agriculture and, in particular, activities associated with cattle farming. Sites with high agricultural emission densities of  $> 30 \text{ kg N ha}^{-1} \text{ yr}^{-1}$  across the surrounding area are predominantly affected by emissions from dairy, beef and poultry farming. The more detailed analysis applied to the five example sites enabled a relatively clear assessment of whether local mitigation measures were likely to be worth considering for targeted mitigation at a site, and/or whether wider regional or national/international efforts would be required to benefit the site.

**Acknowledgements:** This work was financially supported by the Department of Agriculture, Environment and Rural Affairs (DAERA), Northern Ireland.

## REFERENCES

- Carnell E.J., Misselbrook T.H., Dore A.J., Sutton M.A. and Dragosits U. (2017) A methodology to link national and local information for spatial targeting of ammonia mitigation measures. *Atmospheric Environment*, 163, pp 195-204. doi: 10.1016/j.atmosenv.2017.05.051
- Dragosits U., Carnell E.J., Jones L., Rowe E., Hall J.R., Dise N., Dore A.J., Tomlinson S.J., Sheppard L., Reis S., Bealey W., Braban C.F., Misselbrook T.H., Stevens C., O’Shea L., Smyntek P. and Sutton M.A. (2015) Identification of Potential “Remedies” for Air Pollution (nitrogen) Impacts on Designated Sites (R.A.P.I.D.S.). Defra project AQ0834. 59pp (main report) + 11 appendices
- Misselbrook T.H., Gilhespy S.L., Cardenas L.M., Williams J. and Dragosits U. (2015) Inventory of Ammonia Emissions from UK Agriculture 2014. Inventory submission report. Defra Contract SCF0102. Rothamsted Research, North Wyke, Okehampton, Devon EX20 2SB. 38 pp

## FEASIBILITY OF USING INDUSTRIAL ANION EXCHANGE RESIN TO REMOVE NITRATE FROM TILE WATER

WOLF, K.A.<sup>1</sup>, GUPTA, S.C.<sup>2</sup>

<sup>1</sup> Department of Climate and Water, Institute of Agroecology, Aarhus University, Denmark; <sup>2</sup>University of Minnesota, U.S.A.

### INTRODUCTION

The northern Gulf of Mexico is the largest body of hypoxic water (the Dead Zone) in the western Atlantic Ocean. Scientists believe the Dead Zone is caused by nitrate ( $\text{NO}_3\text{-N}$ ) discharged by the Mississippi River into the Gulf of Mexico. The Dead Zone has been ever-increasing since its monitoring began in 1970's. In 2017, it span an area of 22,730  $\text{km}^2$ . The presence of high nitrate levels in the Gulf waters causes increased algal production, which on decay leads to low dissolved oxygen ( $<2 \text{ mg N L}^{-1}$ ) in the water at the bottom of the Gulf (Rabalais et al., 2001). Much of the  $\text{NO}_3\text{-N}$  in the Mississippi River originate from agricultural lands in the Midwestern United States. The subsurface drain tiles are the main pathway for nitrate losses, which farmers have installed to carry excess water from their lands, especially during spring when soils are excessively wet for field operations and optimum crop growth (Goolsby et al. 2001).

Recently, large efforts have been underway to reduce  $\text{NO}_3\text{-N}$  losses from agricultural lands to the US midwestern rivers and then to the Mississippi River. These efforts include recommending optimum timing and amount of N fertilizer applications as well as the use of remediation technologies such as woodchip bioreactors, saturated buffer strips, controlled drainage, and cover crops. However, there has been a varied success especially in the use of above technologies because of the requirement for high residence time of drainage water in these set-ups to mitigate  $\text{NO}_3\text{-N}$ . The objectives of this research was to evaluate the feasibility of using an industrial anion-exchange resin (trapping selected ions while simultaneously releasing another ion) to remediate  $\text{NO}_3\text{-N}$  from tile drain water at the edge of agricultural fields. Remediation set-up was similar to water softener set-up used in most households in the United States. The advantage of using an industrial anion-exchange resin was the instantaneous removal of  $\text{NO}_3\text{-N}$ , as well as reusability of the resin thus making the technology more cost effective. For regeneration of the resin, we also envisioned the use of potash (KCl) instead of common salt (NaCl) such that the waste ( $\text{KNO}_3$ ) can be recycled back to land as fertilizer.

### MATERIAL AND METHODS

The testing of anion-resin to remediate  $\text{NO}_3\text{-N}$  in tile drain water from agricultural lands involved a series of field and laboratory experiments in 2015 and 2016 (Wolf, 2017). In 2015, the field set-up involved passing tile drain water through two PVC columns filled with 11 liters of two different types of resins at the edge of a 0.5 ha soybean field near Vernon Center, Minnesota (Fig. 1a). Two resins from separate manufacturers were tested to compare each resins' efficiency. In 2016, the field testing was with one resin and two tile waters from two different corn fields where hog manure had been applied (Fig. 1b, c). Starting each spring, a small portion of the tile drain water was passed through the resin columns and samples were taken once or twice a day from both the tile and the column outlets. These samples were then analyzed for  $\text{NO}_3\text{-N}$  concentrations to estimate  $\text{NO}_3\text{-N}$  retention. Each week the field columns were exchanged with columns that had been recharged with a 13% KCl solution.

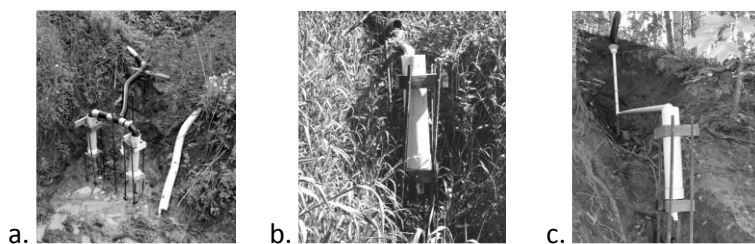

Figure 1a-c: Field set-ups for testing of anion exchange resin to remediate nitrate in tile water. (a) 2015 set-up with two columns containing two different resins and the tile water from a soybean field, and (b) & (c) 2016 set-ups with both columns containing resin #1 but remediating tile water from two different hog manure applied corn fields.

## RESULTS AND DISCUSSION

### 2015 Study

In 2015, resin testing was conducted for a total of 50 days for both types of resin.  $\text{NO}_3\text{-N}$  concentration in tile drain water generally corresponded to about  $15 \text{ mg N L}^{-1}$  during the study period. Comparatively,  $\text{NO}_3\text{-N}$  concentrations coming from the resin were around  $2\text{-}3 \text{ mg N L}^{-1}$  right after recharged columns were installed. During the test period, a total of  $664 \text{ g}$  of  $\text{NO}_3\text{-N}$  passed through resin column #1 and  $313 \text{ g}$  was retained. Comparatively,  $1,031 \text{ g}$  of  $\text{NO}_3\text{-N}$  passed through the resin column #2 and  $271 \text{ g}$  of  $\text{NO}_3\text{-N}$  was retained by the resin. This corresponded to  $\text{NO}_3\text{-N}$  retention efficiency of  $46\%$  for resin #1 and  $26\%$  for resin #2. The difference in the amount of  $\text{NO}_3\text{-N}$  passing through different resin columns is likely due to differences in flow rate between the resins.

### 2016 Study

In 2016, only the resin #1 was tested since it was more efficient than resin #2. Differences in the resin were resin #1 had a total exchange capacity of  $18.2 \text{ mg L}^{-1}$  whereas resin #2 had a total exchange capacity of  $11.89 \text{ mg L}^{-1}$ . Resin testing was done for a total of 55 days at location #1 (L1) and 31 days at location #2 (L2). Nitrate leaching behavior through the resin was similar to that observed in 2015. On average,  $\text{NO}_3\text{-N}$  concentrations in the tile water varied around  $45 \text{ mg N L}^{-1}$  at L1 and around  $30 \text{ mg N L}^{-1}$  at L2. The higher  $\text{NO}_3\text{-N}$  concentration at these locations, relative to 2015 location, was likely due to the application of hog manure at these sites. Over the period of 55 days, a total of  $1,125 \text{ g}$  of  $\text{NO}_3\text{-N}$  pass through the resin at L1 out of which  $593 \text{ g}$  ( $34.5\%$  retention) was retained. Comparatively at L2, a total of  $608 \text{ g}$  of  $\text{NO}_3\text{-N}$  passed through the resin over 31 days and  $48 \text{ g}$  ( $7.3\%$  retention) was retained. The difference in  $\text{NO}_3\text{-N}$  retention efficiency between the two sites is likely due to differences in recharging of the columns as well as due to differences in sulfate replacing the adsorbed nitrate on the resin (Wolf, 2017).

## CONCLUSION

Overall, the resin was very efficient at removing  $\text{NO}_3\text{-N}$  from tile water in the field because of its instantaneous retention properties. Results showed no presence of heavy metals in the leachate thus a strong potential for its recycling as  $\text{KNO}_3$  fertilizer back on the land. Although very effective, we also encountered some challenges in field testing. These include (1) possibility of resin contamination from sediments in the tile drain, (2) interference of other anions such as sulfate, (3) high volume of tile drain water compared to the retention capacity of the resin in small columns, and (4) labor-intensive nature of this technology and our set-ups (Wolf, 2017). In spite of the above challenges, the results of this study do demonstrate the potential use of this resin in remediating water in individual homes in rural settings where groundwater may be high in  $\text{NO}_3\text{-N}$  concentrations. In relation to Danish agriculture, this method could prove as an efficient alternative to removing  $\text{NO}_3\text{-N}$  from drainage water.

**REFERENCES**

- Goolsby, D.A., W. A. Battaglin, B.T. Aulenbach, and R.P. Hooper. 2001. Nitrogen input to the Gulf of Mexico. *J. Environ. Qual.* 30:329-336.
- Rabalais, Nancy N., R. Eugene Turner, and William J. Wiseman. 2001. "Hypoxia in the Gulf of Mexico." *J. Environ. Qual.* 30(2):320-329.
- Wolf, K.A. 2017. Climate and land use change impacts on N-loads in Iowa Rivers and remediation of tile water with an anion-exchange resin. M.S. Thesis, University of Minnesota, St. Paul, MN, USA, pp 144.



## CLIMATE INDICATORS EXPLAINING THE VARIABILITY OF CARBON, NITROGEN AND PHOSPHORUS EMISSIONS TO STREAMS IN HEADWATER AGRICULTURAL CATCHMENT

STROHMENGER, L.<sup>1</sup>, FOVET, O.<sup>1</sup>, GASCUEL-ODOUX, C.<sup>1</sup>.

<sup>1</sup> UMR SAS, INRA, AGROCAMPUS OUEST, 35000 Rennes, France

### INTRODUCTION

Agriculture intensification during the 20th century led to the increase of nutrient inputs in agricultural areas. Water quality deterioration because of these fertilization practices has been acknowledged worldwide (Sun et al. 2018) with increased loads of e.g. nitrate, phosphorus or organic carbon. When used in excess, these elements accumulate within the soil and/or groundwater and are eventually exported at the catchment outlet. Local climate conditions and hydrology control hydro-chemical processes and thus need investigation in order to understand the temporal responses of agro-ecosystem to agricultural activities.

The analysis of long-term hydrological and chemical data series allowed to classify several elements in agricultural headwater catchments depending on their source, based on their 10 years mean concentration and annual seasonality (Aubert et al. 2013; Aubert, Gascuel-Odoux, and Merot 2013): i) anthropogenic origin and storage in upland groundwater (nitrate  $\text{NO}_3^-$  and chloride  $\text{Cl}^-$ ), ii) biogeochemical processes in the wetland and downslope (dissolved organic and inorganic carbon - DOC, DIC- and phosphorus -P-) (Humbert et al. 2015; Dupas et al. 2015).

Climate conditions affect production and/or accumulation of DOC, DIC and P in summer and their export in winter (Humbert et al. 2015). Climate also affects the connectivity between hillslope groundwater - which is the main source of  $\text{NO}_3^-$  - and stream during the wet period. The investigation of DOC, DIC and P concentrations during flood events suggests a progressive depleting of stock throughout the hydrological year (Humbert et al. 2015; Dupas et al. 2015).

Questions remain on how climate affects the carbon (C), nitrogen (N) and P emissions relatively to each other. This study aims to assess how climate controls, at different temporal scales (seasonal and inter-annual), the nutrients exported to surface waters in headwater catchments. It focuses on C, N, P concentrations, the synchrony/asynchrony of their cycles and their ratio dynamics with respect to climate variability.

### MATERIAL AND METHODS

#### Study site and data collection

The study site is the Kervidy-Naizin (Brittany, France) catchment, part of the AgrHyS environmental research observatory ([http://www6.inra.fr/ore\\_agrhys\\_eng](http://www6.inra.fr/ore_agrhys_eng)) since 2002. It is a 5km<sup>2</sup> headwater catchment with oceanic temperate climate. Land use is mostly agricultural: dominated by maize, cereal crops and grassland.

Data were collected at the minute time step for outlet flow, 15 minutes for water table level in 10 locations along the hillslope, and every hour for the rainfall and air temperature. Daily samples provide the base flow concentrations of  $\text{NO}_3^-$  DOC and phosphate ( $\text{PO}_4^{3-}$ ) completed by analysis with higher frequency during some flood events.

#### Method

The first step of this work consists in the description of each year with selected indices, for characterizing climate, hydrology and water quality dynamics. These indices describe the water year with precipitation amount and distribution, total runoff; the dry and wet period durations and

intensities (regarding mean temperature, cumulative rain, water table levels, flood occurrence, water quantity); and the water quality dynamics in particular relatively to variations in discharge or catchment storage.

The cross-comparison of these key values with multivariate statistics (Principal Component Analysis, Heatmaps, Decision trees) is used to identify the relationships between contrasted years in terms of chemical signals with the associated climate conditions. This global analysis is then completed by bi-variate analyzes with the aim of identifying the nutrients production and mobilization mechanisms.

## RESULTS AND DISCUSSION

Many indicators can be derived from the long term data series and reflect the specific characteristics of each hydrologic year in term of climate, hydrology and chemistry. The major ones that influence water concentration dynamics are the cumulative rainfall, dry period duration, water table levels and the flood event occurrence.

Dry season characteristics (duration and intensity) impact the initial state of the sources of C and P while wet season characteristics (water table levels, water volume, flood events) show different relationships with the export depending on the element. These results highlight the crossed and possibly antagonist effects of climate on nutrient emissions because it controls: i) biogeochemical production/accumulation mechanisms via soil saturation dynamics ii) transfer mechanisms by connecting or not different compartments and modifying their relative contributions.

The multi and bi-variate analysis enabled the formulation of assumptions to build a coupled C-N-P conceptual catchment hydro-chemical model by establishing how each hydro-biogeochemical compartment should respond to hydro-climatic indices.

## REFERENCES

- Aubert, A. H., C. Gascuel-Oudou, G. Gruau, N. Akkal, M. Faucheux, Y. Fauvel, C. Grimaldi, Y. Hamon, A. Jaffrézic, M. Lecoq-Boutnik, J. Molénat, P. Petitjean, L. Ruiz, and P. Merot. 2013. 'Solute transport dynamics in small, shallow groundwater-dominated agricultural catchments: insights from a high-frequency, multisolute 10 yr-long monitoring study', *Hydrology and Earth System Sciences*, 17: 1379-91.
- Aubert, Alice Helene, Chantal Gascuel-Oudou, and Philippe Merot. 2013. 'Annual hysteresis of water quality: A method to analyse the effect of intra- and inter-annual climatic conditions', *Journal of Hydrology*, 478: 29-39.
- Dupas, R., G. Gruau, S. Gu, G. Humbert, A. Jaffrezic, and C. Gascuel-Oudou. 2015. 'Groundwater control of biogeochemical processes causing phosphorus release from riparian wetlands', *Water Res*, 84: 307-14.
- Humbert, G., A. Jaffrezic, O. Fovet, G. Gruau, and P. Durand. 2015. 'Dry-season length and runoff control annual variability in stream DOC dynamics in a small, shallow groundwater-dominated agricultural watershed', *Water Resources Research*, 51: 7860-77.
- Sun, M., Z. L. Huo, Y. X. Zheng, X. Q. Dai, S. Y. Feng, and X. M. Mao. 2018. 'Quantifying long-term responses of crop yield and nitrate leaching in an intensive farmland using agro-eco-environmental model', *Science of the Total Environment*, 613: 1003-12.

## EXPOSURE TIME VS. RESIDENCE TIME IN UPSCALING NITRATE MASS LOSS IN THE HYPORHEIC ZONE

GILFEDDER, B.S.<sup>1,2</sup>, DUREJKA, S.<sup>2</sup>, THOMAS, Z.<sup>3</sup>, LE LAY, H.<sup>3</sup>, FREI, S.<sup>2</sup>

<sup>1</sup> Limnological Research Station University of Bayreuth, Universitätsstrasse 30, 95447 Bayreuth, Germany, <sup>2</sup> Department of Hydrology, Bayreuth Center of Ecology and Environmental Research (Bayceer) University of Bayreuth, Universitätsstrasse 30, 95447 Bayreuth, Germany, <sup>3</sup> UMR SAS, AGROCAMPUS OUEST, INRA, 35000 Rennes, France

### INTRODUCTION

Nitrate transport in streams and rivers is one of the primary vectors moving nitrate from terrestrial source areas to sensitive coastal zones. Streams and rivers integrate the runoff and nitrate flux from various land uses and thus give a broad picture of hydrological and biogeochemical coupling at the catchment scale. However, rivers are not simply a transport vector, but a living ecosystems in their own right, with a multitude of chemical, biological and hydrological processes occurring across scales from centimetre (e.g. exchange with ripples, microbial microsites) to continental (whole basins, Gomez-Velez et al., 2015). The hyporheic zone (HZ) is located at the interface between surface water and the groundwater system and encompasses the active exchange between these two reservoirs. The time that the surface waters spends in this interface is known as the residence time (RT). The HZ is considered a biogeochemical 'hot-spot' as it receives chemical species from both the stream (e.g. DOC, nitrate) and from the regional groundwater (e.g. reduced species such as Fe<sup>2+</sup>). This drives a multitude of redox processes ranging from respiration to methane production. The time surface water spends in the HZ that is conducive to reaction is known as the exposure time. In contrast to the RT, which is wholly dependent on hydrological factors, the exposure time is dependent on both hydrology and the biogeochemistry of the rivers subsurface. There has been a keen interest recently in the HZ due to its potential to reduce nitrate loads and function as a natural filter for excess nitrate runoff from agricultural areas. Some estimates have suggested that up to 25 % of nitrate can be removed in the HZ (Kiel and Cardenas, 2014). The majority of experiments have been conducted on small scales (e.g. few tens of meters) using e.g. tracer addition experiments. The means of upscaling nitrate mass loss to tens of kilometres is difficult, and often based solely on numerical modelling (Gomez-Velez et al., 2015). It is also often assumed that the exposure time equals the RT. However, it is well documented that nitrate reduction first begins once oxygen levels are low enough for denitrification and thus previous efforts may have overestimated the nitrate loss in the HZ.

In this communication we present methods to both upscale nitrate loss at catchment scales (using radon as a tracer) as well as calculate loss using both residence times and exposure times. We show clearly that the 'lag' in nitrate reduction due to oxygen in the upper parts of the HZ is critical in assessing the ability of streams to naturally reduce nitrate loads.

### MATERIAL AND METHODS

#### Study site and sampling

Measurements were conducted at the Long Term Ecosystem Research Catchment (LTER) near the town of Pleine-Fougères, about 20 km from Rennes, France. The 2.5 km stream studied here drained a small agricultural sub-catchment of the LTER, known locally as *Vilqué*. It is surrounded by mostly agricultural land including dairy and low intensity crops. Fourteen 1L samples for radon and nitrate analysis were taken from the headwater areas to its confluence with *l'Hermitage* at intervals between 100 m and 500 m. Radon was measured in the field using a RAD7 radon in air detector, with each sample being purged for 5 minutes and then counted for 1 h. Nitrate was measured by ion chromatography.

#### Calculating nitrate mass loss and groundwater fluxes

The groundwater flux, hyporheic depth and mean residence times in the HZ was calculated using the FINIFLUX model (Frei and Gilfedder, 2015). This is a 1D finite element mass-balance model that includes terms such as radon loss to the atmosphere, radioactive decay, groundwater discharge and the hyporheic parameters. The hyporheic parameters and groundwater discharge are fitting variables in the mass-balance. The newest version of FINIFLUX uses three different residence time distributions (RTDs, exponential, gamma and power law distributions) to represent storage in the HZ.

The nitrate loss is based on the UPERflux mass-balance equations for the HZ (Pittroff et al., 2017). In its most basic form the mass-balance encompasses the concentration of nitrate in the stream, water flux through the sediment from the stream, RTD and the kinetics for nitrate reduction in the sediments. It does not include the groundwater nitrate flux.

$$T_{NO_3} = q_h \Delta x (C_{in} - C_{out})$$

(Eq. 1)

With  $T_{NO_3}$  is the nitrate loss,  $q_h$  the water flux through the hyporheic sediments,  $x$  is the reach length, and  $C_{in}$  and  $C_{out}$  are the concentrations of nitrate entering and leaving the HZ respectively.  $C_{in}$  is measured in stream water, while  $C_{out}$  is calculated by convolving  $C_{in}$ , reaction kinetics (first order, or Monod equation) and the RTD:

$$C_{out}(\tau) = \int_0^{\infty} C_{in} e^{-\lambda z} RTD dz$$

(Eq. 2)

The new model has been extended E.q 2 to include a factor  $a$  which describes the RT of surface water in the oxic part of the HZ. This 'lag' essentially cuts away a part of the RTD, ranging from 0 to  $a$  hours, and simulates explicitly the exposure time of nitrate to conditions suitable for reduction. We have varied  $a$  from 0 to 100 h to capture a range of possible values, but based on kinetics of oxygen reduction  $a$  is likely to range between 2-6 hours.

## RESULTS AND DISCUSSION

The radon results show clearly that there is a hot-spot for groundwater discharge to the Vilqué stream at around 500 m from the first sampling location, with activities increasing from 200 Bq m<sup>-3</sup> to 15 kBq m<sup>-3</sup>. This was also observed in the field as spring entering the stream from the bank. The FINIFLUX model fitted the measured data very well ( $r=0.9$ ), with a total groundwater discharge of 430 m<sup>3</sup> d<sup>-1</sup> over 2.5 km. The mean residence time varied depending on the RTD, but in a rather narrow range from 2.3 to 2.48 hours. Over the length of the river measured nitrate concentrations decreased from 44 mg/l to 32 mg/l, due to a combination of dilution by groundwater and reduction in the HZ. The loss of nitrate attributed to reduction in the HZ using UPERflux with  $a=0$ , exponential RTD and first order kinetics was 4.8 kg d<sup>-1</sup>. Implementing an  $a$  with a value of 2 h reduced loss to 2 kg d<sup>-1</sup> due to the inhibitory effect of the oxic zone. To systematically test the influence of RT and  $a$ , we varied these parameters between published values for 1-3rd order streams. We found that the loss of nitrate is highly sensitive to both the RT and  $a$ , with only a small combination of values (RT 1-20 h,  $a < 2$ ) leading to significant nitrate loss (Figure 1). It is also clear that the nitrate loss is inversely related to residence time. Thus to maximise nitrate mass loss in stream networks a combination of short residence times and low values of  $a$  are needed. This work shows that it is vital to consider the exposure of chemicals such as nitrate to conditions conducive to reaction in the HZ, rather than only relying on the residence time in the subsurface.

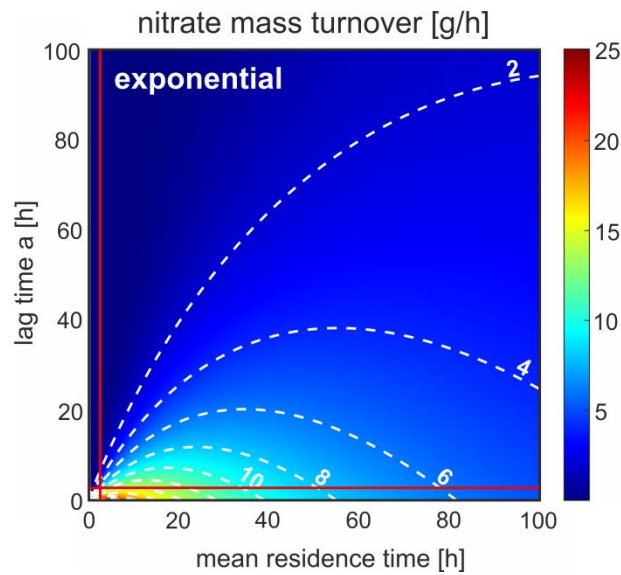

Figure 1: Nitrate mass loss in the hyporheic zone as a function of lag time (portion of RTD allocated to the oxic zone) and mean residence time.

## REFERENCES

- Frei, S., Gilfedder, B.S., 2015. Technical Note: FINIFLUX an implicit Finite Element model for quantification of groundwater fluxes and hyporheic exchange in streams and rivers using Radon. *Water Resources Research* 51, 6776-6786.
- Gomez-Velez, J.D., Harvey, J.W., Cardenas, M.B., Kiel, B., 2015. Denitrification in the Mississippi River network controlled by flow through river bedforms. *Nature Geoscience* 8, 941-945; doi:910.1038/ngeo2567.
- Kiel, B., Cardenas, M.B., 2014. Lateral hyporheic exchange throughout the Mississippi River network. *Nature Geoscience*, 413-417; doi:410.1038/ngeo2157.
- Pittroff, M., Frei, S., Gilfedder, B.S., 2017. Quantifying nitrate and oxygen reduction rates in the hyporheic zone using  $^{222}\text{Rn}$  to upscale biogeochemical turnover in rivers *Water Resources Research* 53, 563-579; doi: 510.1002/2016WR018917.

## SEARCHING FOR THE CONTROL MECHANISMS OF NITROGEN REMOVAL IN A MEDITERRANEAN RIPARIAN FOREST

Poblador, S.<sup>1</sup>, Thomas Z.<sup>2</sup>, Rousseau-Gueutin, P.<sup>3</sup>, Lupon A.<sup>4</sup>, Sabaté S.<sup>1,5</sup>, Sabater, F.<sup>1,5</sup>

<sup>1</sup> Departament de Biologia Evolutiva, Ecologia i Ciències Ambientals, Universitat de Barcelona. Av. Diagonal 643, 08028 Barcelona, Spain. <sup>2</sup> UMR SAS, AGROCAMPUS OUEST, INRA, 35000 Rennes, France. <sup>3</sup> EHESP Rennes, Sorbonne Paris Cité, Paris, France. <sup>4</sup> Department of Forest Ecology and Management, Swedish University of Agricultural Sciences (SLU), Skogsmarksgränd, 901 83 Umeå, Sweden. <sup>5</sup> Centre for Ecological Research and Forestry Applications (CREAF). Campus de Bellaterra Edifici C, 08193, Cerdanyola del Vallès, Spain.

### INTRODUCTION

Riparian zones are often considered ecotone ecosystems between terrestrial and aquatic environments, playing a key role in controlling stream discharge and nutrient exchange. Its unique position within catchments allows a high water availability at the area and the establishment of tree species that support large transpiration rates. Moreover, riparian zones are well-known to be biogeochemical hot-spots that can reduce large amounts of nitrogen (N) loads arriving from hillslopes to the stream, mainly via denitrification and vegetation uptake. However, in arid and semiarid regions, where shallow organic soil layers get disconnected from the groundwater, changes in this biogeochemical control may arise. Mediterranean systems are a unique natural laboratory to understand the close link between riparian hydrology and biogeochemistry due to their marked temporal and spatial variations in soil water content, which can affect not only the stream hydrology, but also the microbial activity in the riparian soils. Here, we summarize results from different studies in order to examine the efficiency of plant uptake and denitrification on reducing N exports from Mediterranean catchments.

### MATERIAL AND METHODS

The study plot (30 m x 25 m) is a riparian forest located at the valley bottom of a forested headwater catchment (14.2 km<sup>2</sup>, 500–1500m a.s.l.), NE Spain. The climate is sub-humid Mediterranean (Precipitation = 925 ± 151 mm; Temperature = 12.1 ± 2.5 °C). The plot exhibits a strong horizontal gradient in terms of groundwater level, soil water content, and riparian tree distribution (Table 1). Therefore, we defined the riparian area in three zones: near-stream, intermediate, and hillslope.

#### Soil N processes

We evaluated the main soil microbial N processes (mineralization, nitrification, and denitrification) and how changes in soil properties can modify them over time and space (detailed information: Poblador et al., 2017).

#### Vegetation water sources

We determined water sources of our riparian tree species by analysing isotopic composition ( $\delta^{18}\text{O}$  and  $\delta^2\text{H}$ ) of trees' sap and the main water sources (shallow soil water, deep soil water, and groundwater). We estimated the most likely proportion of water taken up by plants from each water source using Bayesian mixing models following Barbeta et al. (2015).

#### Water and N fluxes modelling

Following our denitrification capacity and vegetation water sources results, we used a 1D model (HYDRUS) to simulate water flow and N-NO<sub>3</sub><sup>-</sup> transport in the vadose zone of the three riparian zones. We simulated the water and N-NO<sub>3</sub><sup>-</sup> fluxes for the actual period (2012-2014) based on field data, as well as future scenarios (2015-2100) based on the IPCC projections for the Mediterranean zone (Poblador et al., submitted).

## RESULTS AND DISCUSSION

Findings obtained from soil experiments showed high rates of net N mineralization and nitrification as well as large pools of inorganic N. Conversely, denitrification rates in our study plot were really low (Table 1), especially compared with those reported for temperate riparian zones (up to  $2\text{mg N kg soil}^{-1} \text{d}^{-1}$ ; Hefting et al., 2004). These results suggest that vegetation uptake, rather than denitrification, may be the major sink of N-removal in Mediterranean riparian zones.

The isotopic water signal revealed that riparian trees took up >80% of water from the vadose zone, except during spring, when phreatophic species (*Alnus glutinosa* and *Populus nigra*) used groundwater as a main source of water at the near-stream zone. Moreover, the model simulations suggested a higher hydraulic connectivity between vadose zone and groundwater at the near-stream zone. This higher water supply allowed greater transpiration rates at the near-stream (80% of potential evapotranspiration, PET) than at the hillslope zone (60% of PET) (Table 1), where riparian transpiration might be water limited.

Vegetation N uptake was the main N-removal process at the riparian forest, and decreased from the near-stream to the hillslope (Table 1). However, N uptake represented only from 7-13% of N fluxes at the vadose zone, questioning its real N-removal capacity. Climate change projections suggested that a decrease in groundwater level at the area, together with the consequent transpiration restriction, may increase the soil N pools, and thus reduce the effective N-removal area in Mediterranean riparian forests.

Table 1. For each riparian zone (near-stream, intermediate, and hillslope): distance from the stream channel, tree species, groundwater level, soil water content, transpiration, denitrification, and nitrate uptake rates. Values are expressed in annual mean  $\pm$  standard deviation.

	Near-stream	Intermediate	Hillslope
Distance from the stream (m)	0 – 4	4 – 7	7 – 25
Tree species	<i>Alnus glutinosa</i> <i>Populus nigra</i> <i>Robinia pseudoacacia</i>	<i>P. nigra</i> , <i>R.pseudoacacia</i>	<i>Fraxinus excelsior</i> , <i>R.pseudoacacia</i>
Groundwater level (m below soil surface)	0.41 – 0.6	1.20 – 1.35	> 2.20
Soil water content ( $\text{cm}^3\text{cm}^{-3}$ )	$0.38 \pm 0.01$	$0.25 \pm 0.04$	$0.17 \pm 0.04$
Transpiration (mm)	$666 \pm 75$	$536 \pm 46$	$406 \pm 26$
Denitrification ( $\text{g N-NO}_3 \text{ m}^{-2}$ )	$1.05 \pm 0.66$	$0.56 \pm 0.26$	$0.42 \pm 0.21$
Nitrate Uptake ( $\text{g N-NO}_3 \text{ m}^{-2}$ )	$4.48 \pm 0.50$	$3.43 \pm 0.26$	$2.77 \pm 0.14$

## CONCLUSION

Our findings highlight that the hydrological and biogeochemical processes occurring in the vadose zone are key to understand the capacity of N-removal of Mediterranean riparian forests, as well as question the capacity of these systems to reduce N loads reaching streams.

## REFERENCES

- Barbeta A., Mejía-Chang M., Ogaya R., Voltas J., Dawson T.D., Peñuelas J., 2015. The combined effects of a long-term experimental drought and an extreme drought on the use of plant-water sources in a Mediterranean forest. *Global Change Biology*, 21 (3), 1213-1225.
- Hefting, M. M., Clément, J.-C., Dowrick, D., Cosandey, A. C., Bernal, S., Cimpian, C., Tatur, A., Burt, T. P., Pinay, G., 2004. Water table elevations controls on soil nitrogen cycling in riparian wetlands along a European climatic gradient, *Biogeochemistry*, 67, 113–134.
- Poblador S., Lupon A., Sabaté S., Sabater F., 2017. Soil water content drives spatio-temporal patterns of  $\text{CO}_2$  and  $\text{N}_2\text{O}$  emissions from a Mediterranean riparian forest soil. *Biogeosciences*, 14,4195-4208.

## MODELLING MITIGATION SCENARIOS ON A LANDSCAPE IN CENTRAL FRANCE

PASQUIER, C.<sup>1</sup>, BENHAMOU, C.<sup>2</sup>, FRANQUEVILLE, D.<sup>2</sup>, DROUET, J.L.<sup>2</sup>, HENAU, C.<sup>1</sup>

<sup>1</sup> URSOLS, INRA, 45075 Orléans, France

<sup>2</sup> UMR ECOSYS, INRA, 78850 Thiverval-Grignon, France

### INTRODUCTION

Excess of nitrogen, produced by intensive agriculture, is diffused into the environment in reactive forms – such as nitrate (NO<sub>3</sub>), ammonia (NH<sub>3</sub>), and nitrogen oxides (NO<sub>x</sub> and N<sub>2</sub>O). These losses may adversely affect impacts on agroecosystems: soil, water or air pollution, greenhouse gas emission, biodiversity loss. They result from a cascade of numerous processes, which interact spatially and temporally, in agroecosystems. Integrated models are very useful to investigate such complex systems. The aims of this work are to assess the reliability of model predictions on an experimental landscape located in Central France, and to compare the nitrogen budget of actual practices with two nitrogen emission mitigation scenarios, (Pellerin et al., 2017).

### MATERIAL AND METHODS

#### Study site

The study site is a watershed, representative in arable crops in Central France, (Gu et al., 2014). This watershed has an area of 427 ha, it includes 63 fields owned by 9 different farms. The whole crop area is drained. The most common crop rotations is rapeseed-wheat-wheat. The dominant crop is winter common wheat which occupied around 50% of the agricultural land. Pea crop is also present in a few crop rotations.

#### Dataset

Three datasets were implemented (S0, S1 and S2). In S0, based on actual farming practices, data were collected through farmer surveys (fertilization type, date, amount, crop type, sowing, tillage and harvest date, and livestock management). S1 is a scenario including the same main crops as S0 and we added the requirements of the European Nitrate Directive: grass strips along waterway, catch crops, sowing rapeseed crop. To calculate fertilization management we used N balance method calculated with Azolis © and staggered nitrogen inputs. In the S2 scenario, a unique crop rotation was applied in all fields: rapeseed-wheat-pea-rapeseed-wheat-barley.

#### Model assessment

All datasets were implemented in the NitroScape model (Drouet, J.-L. et al., 2012). The NitroScape model was developed by linking four elementary models (CERES-EGC, FARM-EF, FIDES, SURFATM,) representing reactive nitrogen (Nr) transformations and transfers within four compartments of agricultural landscapes: farms and livestock systems, terrestrial agroecosystems, atmosphere and hydrological network. To assess model reliability, we used the S0 dataset and compared output variables with available observations. In years 2014 and 2015, field data were measured in 5 sites, such as soil properties, meteorological data, biomass, N content in vegetation, N<sub>2</sub>O emissions, NH<sub>3</sub> concentrations, nitrate and ammonium concentrations in soil and soil water content.

### RESULTS AND DISCUSSION

The model provided a satisfactory estimate of dry biomass, nitrogen content in biomass and nitrate content in soil. Nitrate content peaks clearly corresponded to fertilization inputs (figure 1). There was some lack of measurements for soil N<sub>2</sub>O emissions during emission peaks to assess the all quality of simulations.



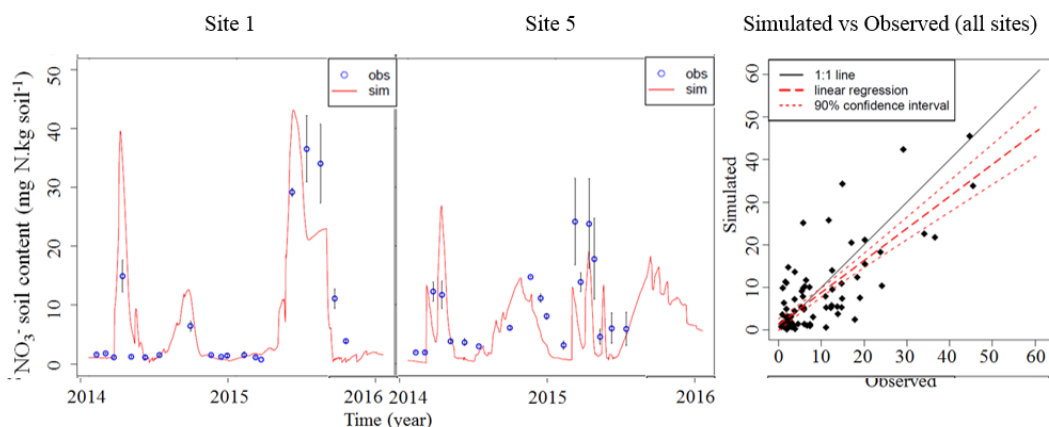

Figure 1.  $\text{NO}_3^-$  soil content of surface layer ( $\text{mg N kg soil}^{-1}$  or ppm).

The European Nitrate Directive implementation (S1) reduced environmental  $\text{N}_r$  losses by 15% (Table 1) and increased nitrogen returned to soil with crop residues by  $12.8 \text{ kg N ha}^{-1} \text{ yr}^{-1}$ . The global nitrate leaching was decreased by  $5 \text{ kg N ha}^{-1} \text{ yr}^{-1}$ . Even though mineral fertilization was reduced by an average of  $40 \text{ kg N ha}^{-1} \text{ yr}^{-1}$  in comparison with actual practices (S0), nitrate leaching was higher of about  $2 \text{ kg N ha}^{-1} \text{ yr}^{-1}$  in the S2 scenario than in S1. This difference was due to an overestimation of symbiotic fixation of nitrogen by pea by the model.

Table 1. Global mineral nitrogen budget ( $\text{kg N ha}^{-1} \text{ yr}^{-1}$  and %) at the end of the simulation period for the three scenarios.

Scenario	S0	S1	S2
Unit	$\text{kg N ha}^{-1} \text{ yr}^{-1}$		
Mineral fertilization	164.61	162.65	123.89
Symbiotic fixation	2.48	2.47	102.99
Harvest exportation	137.01	135.43	195.99
$\text{NO}_3^-$ leaching	29.75	24.65	27.17

## CONCLUSION

The NitroScape model predicted fluxes of different forms of  $\text{N}_r$  in the study site with a consistent order of magnitude in comparison with observed fluxes. Implementation of nitrates directive and new crop rotation provided better performance with a reduction of nitrate losses and an increase of nitrogen use efficiency. These NitroScape simulations demonstrate some ways to reduce  $\text{N}_r$  losses in environment by applying agricultural management scenarios at the landscape scale.

**Acknowledgements:** we thank ANR for funding this study through the ANR Escapade project (ANR-12-AGRO-0003).

## REFERENCES

- Drouet, J.-L., Duret, S., Durand, P., Cellier, P., 2012. Modelling the contribution of short-range atmospheric and hydrological transfers to nitrogen fluxes, budgets and indirect emissions in rural landscapes. *Biogeosciences* 9, 1647–1660.
- Gu, J., Loustau, D., Hénault, C., Rochette, P., Cellier, P., Nicoullaud, B., Grossel, A., Richard, G. (2014). Modeling nitrous oxide emissions from tile-drained winter wheat fields in Central France. *Nutrient Cycling in Agroecosystems*, 98 (1), 27-40.
- Pellerin, S. & al., 2017. Identifying cost-competitive greenhouse gas mitigation potential of French agriculture. *Environmental Science and Policy*, 77, 130-139.

# 20<sup>th</sup> Nitrogen Workshop

## Coupling C-N-P-S cycles

June 25-27, 2018

Le Couvent des Jacobins, Rennes – France

### **Session I: N cycle in landscapes - Posters**

## **GIS-BASED ESTIMATION OF SHALLOW GROUNDWATER NITRATE CONCENTRATIONS: FROM POINT MEASUREMENTS TO THE LANDSCAPE SCALE**

KNOLL, L.<sup>1</sup>, BREUER, L.<sup>1</sup>, BACH, M.<sup>1</sup>

<sup>1</sup> Research Centre for BioSystems, Land Use and Nutrition (IFZ)  
Justus Liebig University Giessen, Germany

### **INTRODUCTION**

In the context of the implementation of the EU Water Framework Directive, the estimation of nitrogen (N) inputs into surface waters and groundwater reached increasing awareness. Particularly nitrate loads from agricultural land use contribute to the high nitrate concentrations observed in the groundwater. To develop effective management plans, a better representation of N flow paths, retention times and denitrification processes in the groundwater body are needed for hydro-biogeochemical models. However, data required for meaningful large-scale applications of these models is often not at hand. In Germany, the river basin management system MoRE (Modeling of Regionalized Emissions) is used to estimate nitrogen loads into surface waters on the national scale. This work aims at developing a new component within the model instrument MoRE to simulate the entry pathways for nitrate from non-point sources through the groundwater.

### **MATERIAL AND METHODS**

Recently, the federal state of Hesse (Germany) provided measurements from about 2.500 monitoring sites (springs, wells and monitoring wells) for nitrate concentrations in groundwater bodies. In addition, a wide range of spatial data on land use, nitrogen surplus on agricultural land, groundwater recharge, hydrogeological conditions and potential denitrification rates in soils is available. Based on this data, we developed a multiple linear regression (MLR) approach for statewide spatial predictions of nitrate concentration in shallow groundwater.

#### **Geodata analysis**

The groundwater data and coordinates were stored as point information in a geodatabase. Different types of contributing area surrogates (CAS) such as circles and wedges were developed to quantify the spatial data in relation to the point measurements. We performed correlation analysis to evaluate dependencies between nitrate and the particular spatial data and identified the most influential parameters.

#### **Multiple linear regression analysis**

With a MLR approach, the relationship between a response variable and multiple significant explanatory variables is modelled. MLR was applied in this work to predict nitrate concentration from the most influential spatial variables. The MLR was performed for different parameter sets of the particular CAS. Furthermore, we tested the performance of the MLR for several hydrogeological subunits.

### **RESULTS AND DISCUSSION**

#### **Geodata analysis**

We identified a high positive correlation between nitrate concentration and percentage of arable land use, a high negative correlation between nitrate and percolation rate and a low positive correlation between nitrate and N-surplus on agricultural land. The performance of the CAS appeared to be lower for smaller CAS designs, commonly the 1.000 m circular CAS showed the highest correlations.

### **Multiple linear regression analysis**

We generated spatially differentiated MLR models from the percentage of arable land use as the most influential explanatory variable and additional variables like percolation rates, groundwater recharge rates, residence times, N-surplus on agricultural land and potential denitrification rates in soils to predict nitrate as the dependent variable. A spatial subdivision in unconsolidated rocks and consolidated rocks characterized as aquifer, aquitard, or a mixture of both, show an efficient improvement of the MLR models. Our MLR models reveals that shallow groundwater nitrate concentrations of the state of Hesse can be explained with an adj.  $r^2$  from 0.37 to 0.54 for different hydrogeological regions. The coefficients of the explanatory variables describe the observed dependencies regarding nitrate concentrations in a good way, but the MLR model does not explain the entire range of the measured nitrate distribution. Keeping in mind that we used only large-scale spatial input data as explanatory variables, our model provides sufficient results and is in line with other similar models based on higher resolution input data and additional point measurements as explanatory variables.

### **CONCLUSION**

The use of statewide, commonly available spatial data as independent variables makes the model applicable to other comparable regions or even on a national scale of Germany. We show preliminary results and discuss how to apply our GIS-based statistical approach to estimate groundwater nitrate concentrations in regions where less field observations are available.

**Acknowledgements:** We thankfully acknowledge the funding by the German Federal Environmental Agency (FKZ 37 1522 2200, UBA). We further would like to thank the Hessian Agency for Nature Conservation, Environment and Geology Tasks and Targets (HLNUG) for providing the data.

## TRACING THE FATE OF <sup>15</sup>N-LABELLED ANIMAL MANURE IN THE ENVIRONMENT

FRICK, H.<sup>1,2</sup>, OBERSON, A.<sup>2</sup>, FROSSARD, E.<sup>2</sup>, WETTSTEIN, H.-R.<sup>3</sup>, BÜNEMANN, E. K.<sup>1</sup>,

<sup>1</sup> Department of Soil Science, Research Institute of Organic Agriculture (FiBL), Switzerland; <sup>2</sup> Institute of Agricultural Sciences, ETH Zurich, Switzerland; <sup>3</sup> Agrovét-Strickhof, ETH Zurich, Switzerland

### INTRODUCTION

Animal manure is suspected to be a major source of nitrate leaching due to its variable N concentration and availability and the resulting difficulties in synchronizing crop N-demand and N-supply. In order to gain a better understanding of the fate of N from fertilizers in the soil-plant-system, N-uptake by the crop, residual N in the soil as well as losses via nitrate leaching and ammonia volatilization after the application of mineral fertilizer or animal slurry will be assessed and compared in a field study over a period of 2.5 years.

Thereby, we will use <sup>15</sup>N-labelling approaches to address the following questions: i) how much N is lost from animal manure by leaching, and ii) how to improve N use efficiency of animal manure and reduce leaching risk?

### MATERIAL AND METHODS

#### Production of <sup>15</sup>N-labelled cattle manure

<sup>15</sup>N-labelled manure will be produced shortly by feeding a young cattle with <sup>15</sup>N-labelled ryegrass hay (*Lolium multiflorum*) over 10 days. Thereby, urine and faeces will be collected separately allowing for detailed analysis of <sup>15</sup>N enrichment in the different components and their respective mineralization potential in a column trial.

For the further experiments, urine and faeces will be mixed relative to their respective excretion amounts. Parts of the resulting slurry will be anaerobically digested following standard procedures for biogas production, or mixed with amendments such as biochar or nitrification inhibitors, respectively. Potential differences in leaching losses and nitrogen use efficiency of the processed manures will be assessed in column experiments.

#### Microplot field study

During the cropping season of 2018, we will apply the <sup>15</sup>N-labelled cattle slurry to microplots in a similar design as suggested by Jokela and Randall (1987), in amount and timing according to common agricultural practice. Thereby, our microplot study will be integrated with an on-farm trial in the canton Solothurn, Switzerland, focusing on different management strategies to prevent nitrate leaching.

Furthermore, we will establish microplots with either <sup>15</sup>N-labelled mineral fertilizer, or without any N fertilization as a control treatment with four replicates and on two different field sites, respectively (i.e. 24 microplots in total). In the subsequent years, microplots will be fertilized together with the surrounding fields with non-labelled fertilizers according to farmer's practice.

Plant and soil (at least up to 90 cm depth) will be sampled upon harvest of each crop. Nitrate leaching will be assessed via so-called self-integrating accumulators (SIAs) (Bischoff, 2007), a method which allows for measuring cumulative NO<sub>3</sub>-losses per area per cropping season. It is based on cylinders filled with an ion exchange resin that will be installed underneath the undisturbed soil profile of the microplots in 100 cm depth and exchanged after the harvest of each crop. Additionally, losses via ammonia volatilization upon manure application in the field will be measured via acid traps for at least 48 hours after manure application. Assessment of <sup>15</sup>N-enrichment in all the mentioned compartments

will allow to trace the fate of the labelled fertilizer components and to establish a soil-system N-balance including leaching losses.

#### **Source identification of nitrate in drainage water via natural abundance of $^{18}\text{O}/^{15}\text{N}$**

In addition to the above described microplot study, the natural abundance of  $^{18}\text{O}/^{15}\text{N}$  in drainage water, sampled with both suction cups and SIAs under five fields in the same region, will be assessed in order to identify sources of nitrate in agricultural drainage water (Stoewer, 2016).

#### **RESULTS AND DISCUSSION**

The  $^{15}\text{N}$ -labelled ryegrass hay has been produced both, in a greenhouse and on a field site by fertilizing ryegrass with  $^{15}\text{N}$ -ammoniumnitrate and will be fed to a young cattle in February 2018. By June 2018, we expect to have first results on the manure properties. For the field and column studies we hypothesize that i) nitrate in the groundwater has variable sources, ii) cattle slurry contributes considerably to nitrate leaching, but that iii) anaerobic digestion or manure amendments will increase N use efficiency, thus, reduce nitrate leaching from cattle slurry.

With this study we expect to gain valuable insights into the sources of nitrate in agricultural drainage water as well as the fate of nitrogen from cattle manure in the environment over several years, helping to develop strategies to optimize N use efficiency.

**Acknowledgements** The research project “NitroGäu” receives financial support from the Swiss Federal Office of Agriculture and the canton of Solothurn.

#### **REFERENCES**

- BISCHOFF, W.-A. 2007. Development and applications of the self-integrating accumulators: A method to quantify the leaching losses of environmentally relevant substances. PhD thesis, TU Berlin.
- JOKELA, W. & RANDALL, G. 1987. A nitrogen-15 microplot design for measuring plant and soil recovery of fertilizer nitrogen applied to corn. *Agronomy journal*, 79, 322-325.
- STOEWER, M. M. 2016. Vulnerability assessment of nitrate leaching on the regional scale using isotope techniques. Dissertation, Albert-Ludwigs-Universität Freiburg, 2015.

## HIGH WATER TABLES DURING WINTER HAVE NO IMPACT ON WINTER WHEAT NITROGEN UPTAKE AND YIELDS UNDER DANISH CONDITIONS

DEICHMANN, M. M.<sup>1</sup>, BØRGESEN, C. D.<sup>1</sup>, THOMSEN, I. K.<sup>2</sup>, ANDERSEN, M. N.<sup>1</sup>

<sup>1</sup> Department of Climate and Water, Institute of Agroecology, Aarhus University, Denmark ; <sup>2</sup> Department of Soil Fertility, Institute of Agroecology, Aarhus University, Denmark

### INTRODUCTION

Denmark is currently testing new management tools for lowering nitrogen (N) leaching from agricultural fields and among the tools tested is controlled drainage (CD). It has been shown that CD can lower N-leaching under Nordic conditions by 60-95% (Weström et al. 2007). It has also been reported that CD under Nordic conditions can improve yields by 2-18 % when applied during the spring and summer season by raising the water table to 70-20 cm below the soil surface (Weström et al. 2007). However, if CD is used to lower N-leaching in Denmark, it must work during the winter where Denmark typically receives surplus precipitation and N-leaching is highest on average (SEGES 2017). Accordingly, CD might result in waterlogging conditions. Waterlogging is known to lower yields and N-uptake in plants (Herzog, Striker et al. 2016), but the intensity of waterlogging stress is depending on the wheat variety (Dickin et al. 2008). This study focuses on the negative effect of CD on wheat yields and wheat N-uptake when applied during winter and whether there are differences in the tolerance of typical Danish wheat varieties to CD.

### MATERIAL AND METHODS

A lysimeter experiment was set up in the semifield of Aarhus University Foulum, Denmark during the growing season 2015/2016. It consisted of 54 lysimeters containing a sandy loam soil. Sowing took place on September 28 with winter wheat of the varieties Belgrade (BG), Benchmark (BM) and Substance (SUB) in random order. The lysimeters treatments consisted of water levels of 5, 10, 20, 30, 40 cm below the soil surface as well as a free drainage control. Treatment started on January 26 and end on April 6, where drainage began. Drainage had finished on April 28. Each treatment had nine replicates with three lysimeters of each wheat variety. Before completely filling the lysimeters, they were fertilized with 50 kg N ha<sup>-1</sup>. The height of the water was measured every third day from January 26 until drainage on April 6. However, these measurements showed technical challenges in controlling the water levels at the wanted heights and the intended water heights had to be adjusted to 10, 20, 25, 35 and 45 cm below soil surface. The lysimeters all received 50 kg N ha<sup>-1</sup> on April 28 and 140 kg N ha<sup>-1</sup> on May 2. Mildew treatment was conducted on May 11. Harvest took place on August 12, where after the plants were sorted into grain and residuals (stem+leaves).

### Chlorophyll-fluorescence

Chlorophyll fluorescence (Fv/Fm) measurements started on April 6 just before drainage started and continued until May 11. Measurements were taken using the Mini-PAM fluorimeter (Walz, Germany). Before measuring, the leaves were dark-adapted with Dark Leaf Clips for 30 min.

### Yield

After sorting the harvested plants into grain and residuals (the samples were dried at 60°C until stable weight was obtained. After drying the total dry matter (DM) Yield, Grain DM Yield and the Residual DM Yield was calculated for each lysimeter.

### Nitrogen-measurements

The N-concentration was determined in the Grain DM and Residual DM in accordance with the Dumas method. The N-uptake for each lysimeter was calculated by multiplying the N-concentration of the Grain DM and Residual DM with the respective Grain DM Yield and Residual DM Yield.

### Statistics

All normally distributed data was subjected to a two ANOVA while data not following a normal distribution was subjected to Kruskal-Wallis test. Both tests were made using R-Studio software (Version 1.1.383).

## RESULTS AND DISCUSSION

Fv/Fm showed no significant difference among treatment and varieties at any point. However, the treatments at 10cm and 20cm had the lowest Fv/Fm values and BM was the variety that performed the worst at the end of treatment. The treatment of 10 cm continued to have the lowest Fv/Fm values though they were not significantly lower than the other treatments. Hence, a longer treatment period or higher water level could induce significant stress on the plants. Neither Total DM yield or Grain DM Yield was affected by treatment, but both showed significant variety effects. In both cases, BG had the lowest average yields while BM had the highest yields (Figure 1a, 1b).

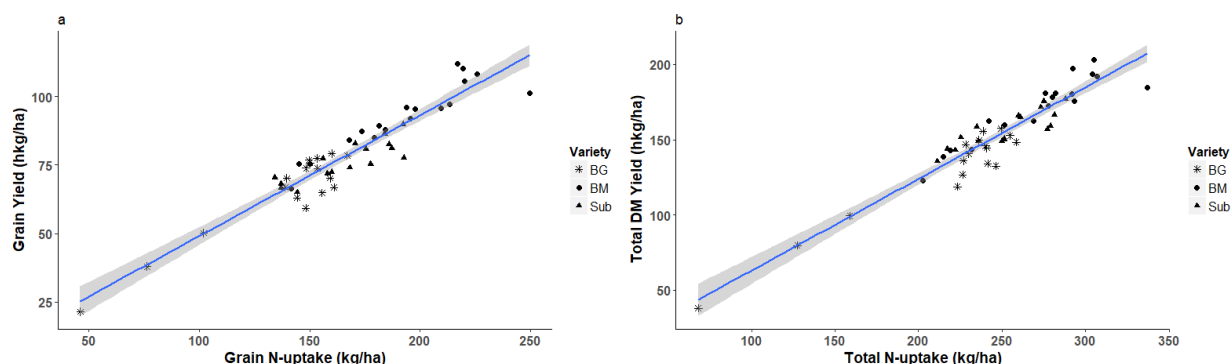

Figure 1: The relation between yields and N-uptake, depending on wheat varieties. Where a shows the grain yield and grain N-uptake and b shows total DM yields and total N-uptake.

At harvest, no effects of either treatment or variety were measured for the grain N-concentration indicating that CD had not impaired the grain quality. However, the total N-concentration was depending on the variety where BG had significantly lower N-concentration compared to both BM and SUB. N-uptake at harvest was not affected by treatments, but BG had the lowest N-uptake while BM had the highest N-uptake (figure 1). This indicated once again that the high-stress levels measured at April 6 on BM before drainage started had no effect on the final N-uptake.

## CONCLUSION

The highest stress levels were measured in the treatments at 10cm and 20cm, and especially at the last day of treatment, though the differences were not significant. This indicated that high water levels for 3-4 months did effect the development and uptake of N in any of the three varieties of winter wheat. Variety however were determining for DM yields and N-uptake at harvest, where BG performed worst. Hence, the stress induced by the treatments had no effect on final DM yields or N-uptake in any of the varieties. Our result indicates that CD could be applied in Denmark during the winter without damaging the N-uptake or yields of winter wheat.

## REFERENCES

- Dickin E., Bennett S., Wright D., 2009. Growth and yield of UK wheat cultivars to winter waterlogging. *Jour. Agri. Sci.* 147, 127-140
- Herzog M., Striker G. G., Colmer T. D., Pedersen O., 2016. Mechanisms of waterlogging tolerance in wheat--a review of root and shoot physiology. *Plat. Cell. Env.* 39, 1068-1086
- SEGES, 2017. Kontrolleret dr ning. SEGES.  
<https://www.seges.dk/innovation-og-udvikling/projekter/kontrolleret-draening>
- Wesstr m I., Messing I., 2007. Effects of controlled drainage on N and P losses and N-dynamics in a loamy sand with spring crops. *Agri. Water. Manag.* 87, 229-240



## **INCREASING THE NITROGEN USE EFFICIENCY AND CONSEQUENTLY THE GROUNDWATER QUALITY IN THE GÄU REGION, SWITZERLAND**

WEY, H.<sup>1</sup>, HUNKELER, D.<sup>1</sup>, BUENEMANN, E.K.<sup>2</sup>

<sup>1</sup> Centre d'Hydrogéologie et Géothermie (CHYN), Université de Neuchâtel, Switzerland <sup>2</sup> Research Institute of Organic Agriculture (FiBL), Switzerland

### **INTRODUCTION**

The loss of nitrogen (N) is one of the biggest unsolved environmental problems of our time: on one hand, nitrogen is a critical yield-limiting factor and therefore N supply in agriculture in the form of fertilizer is crucial to ensure food quality and security. On the other hand, part of this fertilizer is lost to other environmental compartments and leads to the contamination of groundwater, among other issues. Drinking water limits for nitrate are now exceeded in many regions including Switzerland, despite the introduction of measures such as cover crops in winter, adjusted fertilizing strategies and adapted crop rotation systems.

Studies on nitrate leaching frequently use lysimeters or small plots to control experimental conditions, establish mass balance and, in general, achieve statistically sound conclusions. However, these methods do not fully represent real agricultural practices. With this experimental study in the Gäu region in the Swiss Plateau, we aim at bridging the gap between highly controlled small-scale experiments and plot-scale studies on real agricultural fields. In this presentation, the experimental design is detailed, consisting of various monitoring devices, as conclusions on the nitrate leaching itself are not yet available by Summer 2018.

### **MATERIAL AND METHODS**

When studying nitrate leaching under field conditions, there are two challenges: first, both the high spatial variability (“hot spots”) and the temporal dynamics have to be considered to identify “hot moments” of nitrate leaching, potentially leading to an excessive number of samples. Second, the “true” leaching losses have to be determined, which is not identical with nitrate in the root zone as it might be subject to later plant uptake. Our experimental design addresses these two challenges as follows:

- Sampling strategies able to efficiently capture the spatial variability of nitrate leaching (nitrate passive samplers, soil coring) are combined with those that yield a high temporal resolution (suction cups) for selected locations (Figure 1).
- To identify the complete downward transport of nitrate to the groundwater table, not only the root zone, but also the entire unsaturated zone is covered (vadose zone monitoring, Figure 1).
- Agricultural management practices can be carried out unrestrictedly as all installations are completely buried.

The study is multidisciplinary, as knowledge from soil science is connected with agricultural science and hydrogeology.

On eleven fields, managed by the farmers according to their usual management, nitrate leaching under status quo conditions is assessed (Figure 1, Table 1). In addition, two improved agricultural practices, implemented on a strip in each of six fields (annotated with “HYD” in Table 1), will be directly compared to the baseline scenario. Current options for improved practices include measuring all fluxes necessary for a full N budget on the field scale, subsequently allowing for a better adjustment of the fertilizer and manure amount. Moreover, the reduction of the amount of fertilizer applied and the application of a

controlled release fertilizer offer great promise in reducing leaching. It will be decided in Summer 2018 which measures to implement.

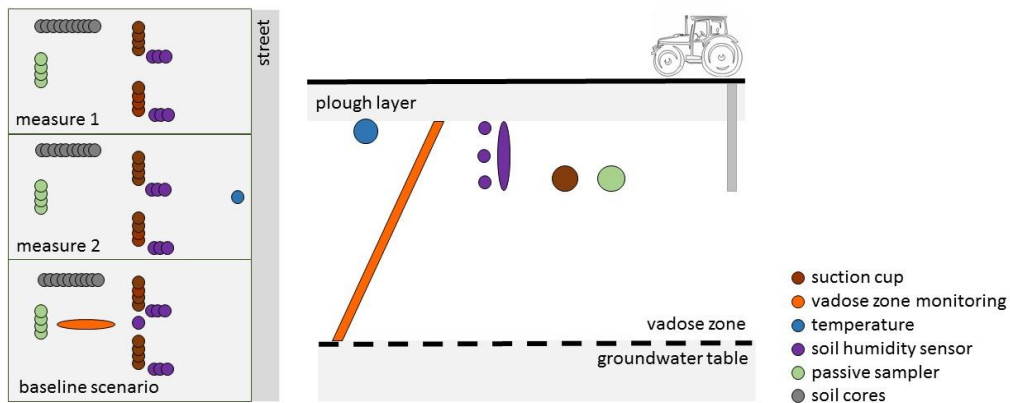

Figure 1: The measurement strategies and the instruments.

Table 1. The experimental design with the specification of the 11 monitored fields.

field code	system		crop rotation									measurements					
	conventional	organic	2018			2019			2020			soil coring	passive samplers	suction cups	vadose zone monitoring		
BIK1		x	pasture	pasture	pasture	corn	crop	crop	crop	crop	pasture	pasture	pasture	x	x		
BIK2		x	pasture	pasture	pasture	corn	crop	crop	crop	crop	pasture	pasture	pasture	x	x		
BIK3		x	pasture	pasture	pasture	corn	crop	crop	crop	crop	pasture	pasture	pasture	x	x		
BIK4	x		pasture	pasture	pasture	corn	crop	crop	crop	crop	pasture	pasture	pasture	x	x		
BIK5	x		pasture	pasture	pasture	corn	crop	crop	crop	catch crop	catch crop	catch crop	catch crop	x	x		
BIK6 / HYD1	x		pasture	pasture	pasture	corn	crop	crop	crop	pasture	pasture	pasture	pasture	x	x	x	
HYD2	x		pasture	pasture	pasture	corn	crop	crop	crop	crop	crop	crop	crop	x	x	x	
HYD3	x		pasture	pasture	pasture	corn	crop	crop	crop	crop	crop	crop	crop	x	x		x
HYD4	x		corn	crop	crop	crop	crop	crop	crop	crop	crop	crop	crop	x	x	x	
HYD5	x		corn	crop	crop	crop	crop	crop	crop	crop	crop	crop	crop	x	x	x	
HYD6	x		corn	crop	crop	crop	crop	crop	crop	pasture	pasture	pasture	pasture	x	x		

pasture  
  corn  
  crop  
  canola  
  catch crop

## RESULTS

By June 2018, it is expected that the first results for  $N_{min}$  soil coring and soil water analysis from the suction cups will be available for a first comparison of methodology.

**Acknowledgement.** The research project “NitroGäu” receives financial support from the Swiss Federal Office of Agriculture and the canton of Solothurn.

## **UPSCALING WATER AND NUTRIENT USE EFFICIENCIES FROM FIELD TO CATCHMENT SCALE: A CASE STUDY IN THE SELKE CATCHMENT, GERMANY**

SILVA, J.V.<sup>1</sup>, JOMAA, S.<sup>2</sup>, CHUKALLA, A.<sup>1</sup>, YANG, X.<sup>2</sup>, MERBACH, I.<sup>2</sup>, RODE, M.<sup>2</sup>, ANTEN, N.P.R.<sup>1</sup>, VAN ITTERSUM, M.K.<sup>1</sup>, REIDSMA, P.<sup>1</sup>

<sup>1</sup> Wageningen University (WU), Wageningen, The Netherlands;  
<sup>2</sup> Helmholtz Centre for Environmental Research (UFZ), Magdeburg, Germany

### **INTRODUCTION**

Sustainable intensification aims to reconcile food production and environmental quality of agricultural systems through its focus on yield gap closure and high resource use efficiency. In agronomy, this has been assessed at field and farm levels (e.g., Silva et al., 2017), but its environmental impacts on water quality at larger spatial scales are poorly understood. Bridging this knowledge gap requires an upscaling protocol to integrate field/crop level approaches in methodologies able to explore water and nutrient dynamics at catchment scale (e.g., Jomaa et al., 2016). The objective of this research is to develop and test an upscaling protocol from field to catchment scale able to reconcile food production, nutrient management and water quality dimensions of agricultural systems, using the Selke catchment (Germany) as a case study.

### **MATERIAL AND METHODS**

The Selke catchment is a tributary of the Bode River and can be described as a mesoscale, lower mountain range catchment which drains an area of ca. 456 km<sup>2</sup>. The elevation in the catchment varies between 605 m at the headwater and 53 m at the catchment outlet. Forest is the dominant land use in the mountain areas, covering ca. 35% of the catchment area, and agriculture is the dominant land use in the lowland areas and with a share of 58% of the catchment area. Two main soil types can be distinguished throughout the catchment, namely cambisols in the mountain areas and chernozems in the lowland areas.

Long-term data on crop phenology, crop yield and N uptake from the Static Fertilization Experiment of Bad Lauchstädt (1978 - 2016) were analyzed for the main crops in the region, namely ware potato, sugar beet, winter wheat, spring barley and silage maize. These data were used to assess empirically the relationships between N applied and N uptake and between N uptake and crop yield using the three quadrant diagram of de Wit (1992). As a next step, the crop model WOFOST is evaluated against these field data and applied to describe the temporal dynamics of N uptake by the different crops and to simulate potential, water-limited and nitrogen-limited yields throughout the Selke catchment.

Long-term daily discharge and water quality data (1993-2016) for the Selke catchment has been recorded in three gauging stations, representing the spatial heterogeneity of the catchment. The process-based, semi-distributed HYPE (HYdrological Predictions for the Environment) model was used to represent the hydrological response and nitrogen concentration in the Selke catchment. The crop-specific N uptake processes and their parameters' identification in the HYPE model were refined based on the insights gained from the Static Fertilization Experiment and based on the crop model WOFOST. Then, the effect of different sustainable crop intensification and resource use efficiency measures were tested and compared to the baseline situation.

### **RESULTS AND DISCUSSION**

Descriptive statistics of the empirical data used to parameterize WOFOST are presented in Table 1. Crops yields between 2.1 and 12.6 t DM/ha for spring barley and silage maize, respectively, were observed when no fertilizer was applied. The N uptake associated with these yields varied between 37.5 kg N/ha for spring barley and 83.5 kg N/ha for silage maize. Application of N as mineral fertilizer

increased yields of all crops except sugar beet, which can be explained by considerable increases in N uptake compared to the ON treatment. These data provide preliminary insights into the interaction between N use efficiency and crop yield in the region and further efforts will focus on refining this across the Selke catchment using WOFOST.

Table 1. Descriptive statistics of crop yield and N uptake in harvestable organs and biomass for arable crops in two N treatments of the Static Fertilizer Experiment, Bad Lauchstädt (Germany).

Crop	Years	N applied (kg N/ha)	N uptake (kg N/ha)	Yield (t DM/ha)
Winter wheat	2000 – 2016	0	53.5 ± 14.8	3.5 ± 1.1
		100	154.3 ± 30.2	7.3 ± 1.6
Spring barley	2000 – 2016	0	37.5 ± 10.2	2.1 ± 0.7
		80	90.5 ± 34.1	3.9 ± 1.3
Ware potato	2000 – 2014	0	49.0 <sup>†</sup> ± 12.0	4.1 ± 1.3
		140	85.5 <sup>†</sup> ± 23.2	5.7 ± 1.9
Sugar beet	2000 – 2014	0	64.5 ± 19.0	7.5 ± 3.0
		170	161.3 ± 63.6	6.8 ± 3.9
Silage maize	2015 – 2016	0	83.5 ± 27.2	12.6 <sup>‡</sup> ± 2.7
		140	157.1 ± 27.5	16.4 <sup>‡</sup> ± 3.7

<sup>†</sup>Data refers to potato tubers only. <sup>‡</sup>Data refers to aboveground biomass.

The HYPE model was calibrated and validated successfully at the three gauging stations for discharge (lowest Nash-Sutcliffe Efficiency, NSE, was 0.81) and nitrogen concentration (lowest NSE was 0.65). The simulations of nitrogen concentration improved, particularly, when the N uptake parameters of the HYPE model were refined based on empirical field data (we expect to achieve similar results based on WOFOST simulations). Then different sustainable crop intensification scenarios, suggested by the stakeholders, were evaluated using the HYPE model at the Selke catchment. For instance, preliminary results showed that 20% reduction of nitrogen fertilizer application reduces the nitrogen loads by 6% compared to baseline conditions. Detailed results of the impacts of different sustainable crop intensification will be presented and discussed.

## CONCLUSION

Improving the description of the processes governing crop growth and nutrient uptake in a spatially explicit semi-distributed hydrological model allows future assessments of yield gaps, resource use efficiencies and water quality at catchment scale. Insights in these different dimensions of agricultural systems can be used in *ex-ante* analyses of environmental policies within the EU, particularly in the context of the water and nitrates framework directives.

**Acknowledgements:** This research was funded by Netherlands Organization for Scientific Research (NWO) via the WaterFARMING project (Grant Agreement No: 689271).

## REFERENCES

- de Wit, C.T. 1992. Resource use efficiency in agriculture. *Agricultural Systems*, 40:125-151.
- Jomaa, S., Jiang, S., Thraen, D., Rode, M. 2016. Modelling the effect of different agricultural practices on stream nitrogen load in central Germany. *Energy, Sustainability and Society*, 6:11.
- Silva, J.V., Reidsma, P., van Ittersum, M.K. 2017. Yield gaps in Dutch arable farming systems: Analysis at crop and crop rotation level. *Agricultural Systems*, 158: 78-92.

## **IN-STREAM NITRATE ASSIMILATORY UPTAKE ANALYSIS BASED ON HIGH FREQUENCY MEASUREMENTS**

YANG, X., JOMAA, S., RODE, M.

Helmholtz Centre for Environmental Research - UFZ, Germany

### **INTRODUCTION**

Streams receive nutrients from terrestrial exports and point sources contribution. They do not only deliver nutrients at the outlet, but also transform and remove them through various physical and biogeochemical processes, which strongly modify the surface water quality. Therefore, understanding in-stream nutrient processes is essential for quantifying nutrient removal and environmental conservation.

Field experiments using isotope tracers have been numerous conducted to quantify in-stream nutrient uptake, especially nitrate uptake. However, traditional field studies could not represent the spatiotemporal variability. Benefiting from the extension of in-situ sensor technology development high frequency environmental information is becoming increasingly available. Spatial and temporal representations are covered by multi-site and continuous sensor deployments, respectively. In this study, we (i) analyzed five years' continuous data from two nested multi-parameter sensor monitoring deployments, (ii) determined the most influential factors for in-stream nitrate assimilatory uptake spatiotemporally, and (iii) developed a parsimonious calculating method and compared model results with calculations derived from high frequency measurements.

### **MATERIAL AND METHODS**

#### **Study site**

The Selke catchment (456 km<sup>2</sup>) is a subcatchment of the Bode River, one of the TERENO observatories in Central Germany. The land-use conditions of upper and lower parts of the Selke catchment are in striking contrast, with about 73% dominated by forests and 80% dominated by arable lands, respectively. Two multi-parameter sensors were deployed in the nested catchment. Station Meisdorf is located at the outlet of the forested sub-basin, representing forested streams. While, the station Hausneindorf is the catchment outlet, representing the typical open-canopy agricultural stream condition.

#### **High-frequency measurements**

The YSI 610 multi-parameter probes measured temperature, dissolved oxygen (DO), pH and electric conductivity at 15 min interval. High frequency nitrate-N concentrations (15 min interval) were measured by a TRIOS proPS-UV sensor. 15-min discharge and meteorological data (i.e., air temperature, air pressure, precipitation and global radiation) were collected from the State Agency for Flood Protection and Water Management of Saxony-Anhalt (LHW) and German Weather Service (DWD). Leaf Area Index (LAI) data were collected from remote sensing data (NEO). All data were collected continuously from 1<sup>st</sup> January, 2011 to 31<sup>th</sup> December, 2015 at both stations. After the methodology of Rode et al. (2016), five-year's daily nitrate assimilatory uptake data were calculated based on Net Ecosystem production, i.e., gross primary production (GPP; gO<sub>2</sub> m<sup>-2</sup> d<sup>-1</sup>) minus ecosystem respiration (ER; gO<sub>2</sub> m<sup>-2</sup> d<sup>-1</sup>). Potential uptake rate (a universal parameter introduced in this study) was then determined.

#### **Factor analysis**

The unique five-year's continuous N uptake data offers the opportunity of further analyzing influential factors on in-stream nitrate processes spatially and temporally. Based on previous understanding, the potentially influential factors can be identified (e.g., Photosynthetic Active Radiation - PAR, water

temperature, riparian shading). The new data are used to quantify effects of these factors on assimilatory nitrogen uptake according to different seasons and stream conditions. We specified a parsimonious approach to calculate assimilatory nitrate uptake based on LAI and PAR.

## RESULTS AND DISCUSSION

### Daily N uptake data

Based on the correlation between gross primary production (GPP,  $\text{gO}_2 \text{ m}^{-2} \text{ d}^{-1}$ ) and assimilatory N uptake ( $U_a\text{-NO}_3^-$ ,  $\text{mgN m}^{-2} \text{ d}^{-1}$ ), the five-year time series of daily  $U_a\text{-NO}_3^-$  were calculated in both forested and agricultural reaches. They showed different seasonal patterns. In the forested reach, the uptake increased considerably in spring (reached to the highest value right before riparian leaves coming out) but decreased sharply and maintained at a low level until winter (Fig. 1, left). While in the agricultural reach, the uptake kept increase after spring and reached peaks in summer (Fig. 1., right).

### Influential factors and simulation results

According to linear regression analysis between N uptake and different parameters in the agricultural reach, the most influential factor was identified as PAR. While water temperature presumably explained the unexpected high values in springs of last three years. The sharp reduction of N uptake in the forest reach is mostly due to the shading effect of riparian vegetation. We considered LAI information to represent the riparian shading. Results showed that the parsimonious approach could explain well the seasonal patterns in both forested and agricultural reaches (Fig 1.).

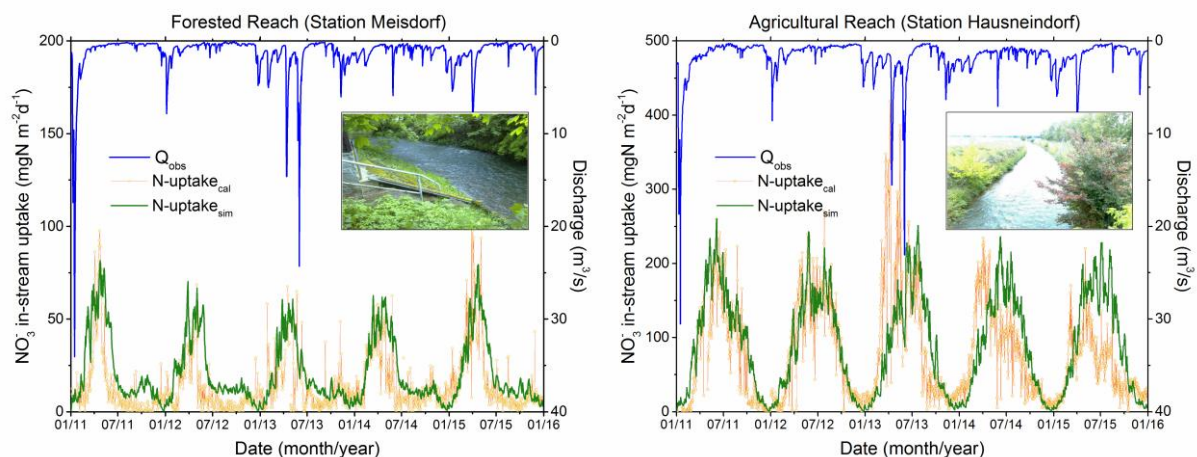

Figure 1. Five-year continuous Nitrate assimilatory uptake and simulation results of the forested and agricultural reaches, Selke catchment.

## CONCLUSION

Benefiting from the high-frequency sensor measurements, continuous time series of in-stream nitrate assimilatory uptake were calculated for different stream conditions. Moreover, those high-frequency data were used to formulate and validate a parsimonious modelling approach. The new approach can be used to upscale the in-situ insights from reach investigations to whole stream networks of a given catchment.

## REFERENCES

Rode, M., S. Halbedel née Angelstein, M. R. Anis, D. Borchardt, M. Weitere (2016), Continuous In-Stream Assimilatory Nitrate Uptake from High-Frequency Sensor Measurements, *Environ. Sci. Technol.*, 50(11), 5685-5694.

## **AGRICULTURAL NITROGEN BUDGET AND GROUNDWATER QUALITY IN A PORTUGUESE VULNERABLE ZONE**

FARO, A.F.<sup>1</sup>, CAMEIRA, M.R.<sup>2</sup>, ROLIM, J.<sup>3</sup>, CORDOVIL, C.<sup>4</sup>, DRAGOSITS, U.<sup>5</sup>

1 Universidade de Lisboa, Instituto Superior de Agronomia MSc student, Portugal; 2,3,4 Universidade de Lisboa, Instituto Superior de Agronomia, LEAF Research Centre, Portugal; 5 NERC Centre for Ecology & Hydrology, Edinburgh, UK

### **INTRODUCTION**

The aim of the Nitrates Directive (EC, 1991) is to reduce water pollution induced by nitrates from agricultural sources in the designated Nitrate Vulnerable Zones (NVZ). In these areas, Member States must establish programmes of measures to be adopted by farmers. They are also required to report the status of water quality and trends to the EC. This study contributes with a methodology to identify and quantify groundwater contamination sources associated with agricultural practices. A case study is presented for the Tagus Vulnerable Zone to Nitrates (TVZ) to evaluate the impacts of the Nitrates Directive (ND) implementation in 2004.

### **MATERIAL AND METHODS**

#### **Study area and data sources**

The TVZ comprises 241,686 ha (60 % total NVZ area in Portugal), comprising 20 municipalities and 72 parishes. In this region, agriculture is of major economic importance, with the most important crops being irrigated grain corn and horticulture for industry, followed by vineyards, olive groves and permanent pastures. About 48 % of the soils have high permeability (Haplic Podzols and Regosols). The climate is Mediterranean with hot dry summers and mild wet winters. The TVZ extends over a hydro-geologically complex area, comprising two layered aquifers separated by an aquitard with a reduced permeability. The study was carried out using decadal information for years with detailed data availability (1989 to 2009) from the National Agricultural Census (INE, 2017) regarding crop areas and yields, livestock populations and fertilization. Other information includes data series regarding nitrate concentrations in the groundwater (SNIRH, 2017) and N deposition (EMEP, 2017). To assess the spatial distribution of ground water contamination and its relation with agricultural practices over the TVZ several maps were used e.g. administrative limits, soil classification and Corine Land Cover. The base data and the calculation procedures were integrated in a Geographical Information System using the QGIS software.

#### **N gross balance, groundwater quality and global risk index**

The nitrogen gross balance (GNB) was calculated for representative groups of crops, at the highest spatial resolution (parish level), applying the OECD methodology (Eurostat, 2013). The inputs considered were the N in mineral fertilizers and animal manures, N deposition, N in the irrigation water, biological N fixation and N from crop residues. The output was the crop N uptake. Thus, the N surplus represents the total potential loading from N. In order to assess the groundwater contamination with nitrates, the risks associated with the N surplus, given the soil permeability and groundwater depth were combined in a global risk index (GRI). This index was analyzed together with the nitrate concentration [ $\text{NO}_3^-$ ] time series from the monitoring wells.

### **RESULTS AND DISCUSSION**

#### **N surplus**

As a general rule, the municipalities with the highest N surplus were dominated by grain maize and vegetable crops, with lower N surplus in areas of legume crops and permanent pastures. Results show a reduction of 46% in the N surplus between 1989 and 2009, which can be directly linked to the

designation of the NVZ in 2004, when the measures affecting the calculation of the fertilization plans started to be implemented.

### Global Risk Index and groundwater quality

Figure 1a shows a considerable decrease of the GRI in almost all municipalities. This trend is reflected in Fig 1b showing two example wells in the upper aquifer where the  $[\text{NO}_3^-]$  has been slowly decreasing. Nevertheless, in the deeper semi confined aquifer (Fig 1c), concentrations have been slowly increasing over time while remaining well below the maximum permitted value of  $50 \text{ mg L}^{-1}$ .

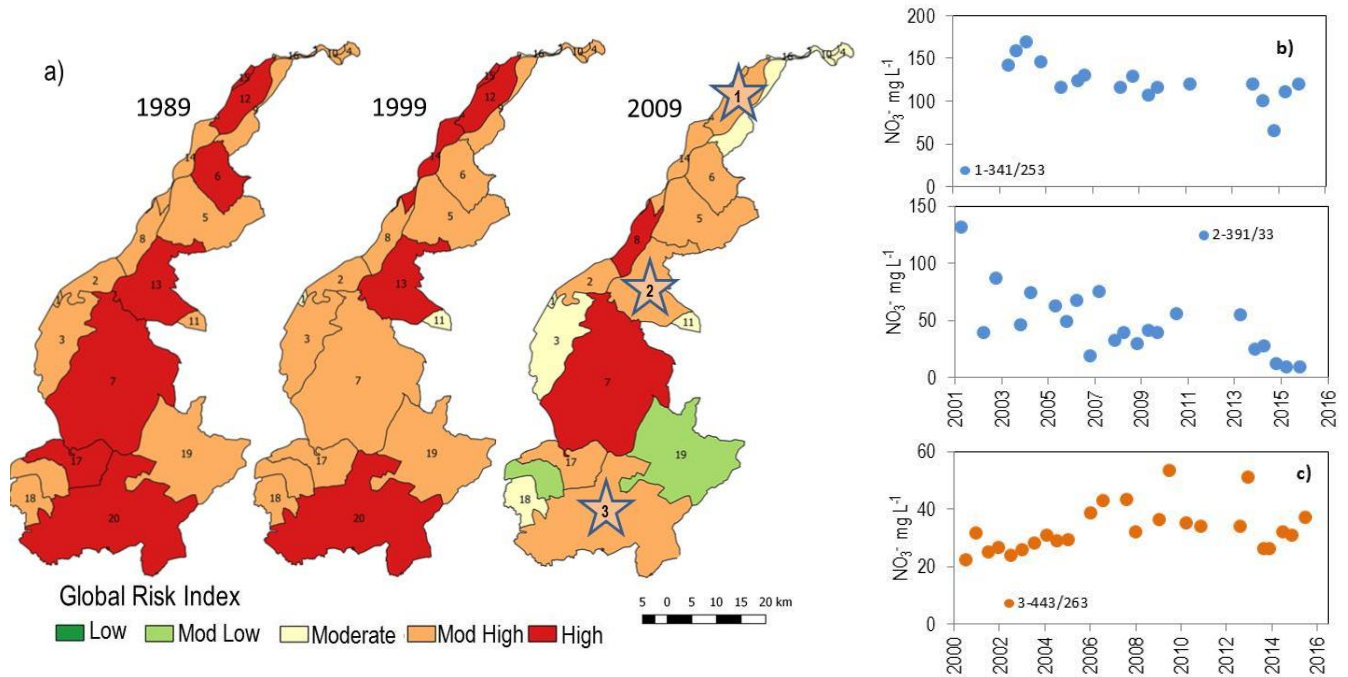

Figure 1. a) Evolution of the risk index for groundwater contamination with nitrates with the location of the three example wells; b) monitoring data from two wells in the upper aquifer; c) monitoring data from one well in the deeper aquifer.

### CONCLUSION

Overall, an improvement is observed in the groundwater quality after the implementation of the ND measures. This improvement is substantial in the irrigated areas in the middle and upper part of the TVZ, where the highest input of N in the balance comes from mineral fertilizers. Nevertheless, in the Southern part there is an inverse trend, particularly in the deeper aquifer, indicating that nitrate is passing through the low permeable aquitard that connects the aquifers, or in some cases travelling through the vadose zone. This trend is not explained by the changes in the N surplus nor the GRI, and is probably related to increased application of livestock manures, and also increasing sewage associated with the urban development this part of the TVZ over recent years.

**Acknowledgements:** Authors thank the NitroPortugal, H2020-TWINN-2015, a Coordination & support action n. 692331 project for funding.



**REFERENCES**

- European Commission, 1991. Council Directive 91/676/EEC of 12 December 1991 concerning the protection of waters against pollution caused by nitrates from agricultural sources. Official Journal 1991;L 375 [31/12/1991]
- Eurostat, 2013. Methodology Handbook: Nutrient Budgets. Version 1.02. Eurostat; OECD, Luxembourg.
- EMEP, 2017. <http://www.emep.int/>
- INE, 2017. <https://www.ine.pt>
- SNIRH, 2017. <http://snirh.apambiente.pt>

## INDIRECT EMISSION OF NITROUS OXIDE FROM RIVERS: FIRST RESULTS OF A STUDY ON THE LOIR WATERSHED

GROSSEL, A.<sup>1</sup>, PASQUIER, C.<sup>1</sup>, BOURENNANE, H.<sup>1</sup>, HENAULT, C.<sup>1</sup>

<sup>1</sup> URSOLS, INRA, 45075 Orléans, France

### INTRODUCTION

The greenhouse gas (GHG) N<sub>2</sub>O is mainly produced in cropped soils (direct emissions) or in water after transfer of nitrogen used in agriculture by leaching or run-off (indirect emissions). According to CITEPA (2014), direct and indirect emissions from agricultural soils contribute to 4.2 and 3.4% respectively, of GHG emissions in France. These values are calculated by the Tier 1 methodology: the N<sub>2</sub>O loss is given by  $N - N_2O = EF_5 \times (total\ N\ input \times Frac_{leach})$ , where  $Frac_{leach}$  is the fraction of the original total fertilizer N input into the system that is lost to waterbodies and  $EF_5$  is the emission factor for freshwater. IPCC (De Klein et al., 2006) provides a factor  $EF_5 = 0.0075$  [0.0005 - 0.025]. This value presents a large uncertainty and is still debated. In this paper, we investigate the nitrogen spatial distribution in the Haut-Loir watershed (France), with a special focus on dissolved N<sub>2</sub>O concentrations to improve quantification of N<sub>2</sub>O emission by rivers to the atmosphere.

### MATERIAL AND METHODS

#### Study watershed

The studied area is the Haut-Loir watershed (137 km long, draining 3453 km<sup>2</sup>), including 15 smaller watersheds. Hydrological processes are different east and west of the Loir. The eastern part (Beauce) overlays the Beauce limestones; precipitations infiltrate down to the Beauce aquifer through this permeable layer. This explains why there are only 2 tributaries, the Conie and Aigre rivers, fed by the Beauce aquifer. The western part (Perche area) presents a dense tributary network with surface hydrology (Fig. 1).

#### OSUR database

Nitrate (NO<sub>3</sub><sup>-</sup>) and ancillary data of 16 sites in 2013-2014 in the Haut-Loir were taken from the OSUR database (<http://osur.eau-loire-bretagne.fr/exportosur/Accueil>). This database was combined with other databases (IGN, AGRESTE, RPG, RRP) to give information on the spatial environment (cropped areas, drainage, wetlands...).

#### Dissolved nitrous oxide and ancillary measurements

We propose to enrich the previous database with dissolved N<sub>2</sub>O values collected during 2017. Water samples of the Loir and its tributaries were taken monthly at 5 sites and twice a year at 22 points (including the 16 OSUR sites, Fig. 1). Dissolved N<sub>2</sub>O contents were measured by the headspace equilibration method with N<sub>2</sub>O concentration determined by gas chromatography. NO<sub>3</sub><sup>-</sup>, nitrite (NO<sub>2</sub><sup>-</sup>) and ammonium (NH<sub>4</sub><sup>+</sup>) were measured by colorimetry. Water pH, redox potential Eh and water and air temperature were directly measured *in situ*.

#### Data analysis

Mean concentrations were compared by t-test. A factorial discriminant analysis (FDA) was applied on the 2013-2014 OSUR database to discriminate various biogeochemical regions inside the Haut-Loir watershed based on the measured variables.

### RESULTS AND DISCUSSION

#### OSUR database (2013-2014)

The FDA enabled to discriminate very clearly 3 groups corresponding to the regions: (1) Perche, (2) Beauce and (3) areas having contributions of both (mixt) with a 6% probability of mis-classification.  $\text{NO}_3^-$  concentration appears the most discriminant variable with higher and almost constant weights over time in the Conie and Aigre waters (Beauce area). Seasonal variations were observed in waters from the Perche area. Mean  $\text{NO}_3^-$  concentrations in water were significantly ( $p < 0.01$ ) different between the geographical areas with values of  $11.1 \text{ mg N.L}^{-1}$  of  $\text{NO}_3^-$  ( $n=30$ ) in Beauce,  $8.2 \text{ mg N.L}^{-1}$  ( $n=22$ ) in mixt areas and  $5.0 \text{ mg N.L}^{-1}$  ( $n=118$ ) in Perche. These differences can probably be related to the watershed hydrology directly from the aquifer in the Beauce area while the rivers of Perche are fed by superficial and drainage waters.

### Dissolved $\text{N}_2\text{O}$ database (2017)

Dissolved  $\text{N}_2\text{O}$  concentrations in the studied river water (Fig. 1) were consistent to those previously observed in the Seine watershed (Garnier et al., 2009) with mean values of  $2.8 \mu\text{g N.L}^{-1}$  of  $\text{N}_2\text{O}$ ,  $1.4 \mu\text{g N.L}^{-1}$  of  $\text{N}_2\text{O}$  and  $0.78 \mu\text{g N.L}^{-1}$  of  $\text{N}_2\text{O}$  in the regions: (1) Perche, (2) Beauce and (3) mixt areas. As for  $\text{NO}_3^-$ , the differences were significant ( $p < 0.01$ ) between areas.

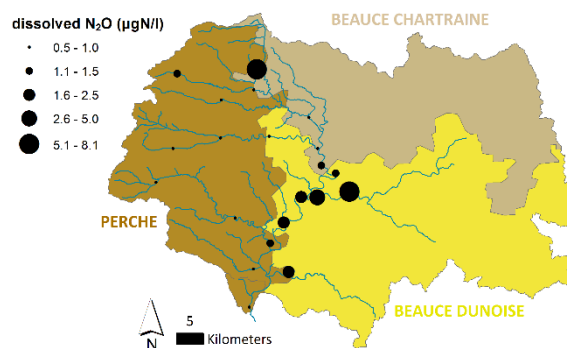

Figure. 1. Dissolved  $\text{N}_2\text{O}$  measured in a snapshot campaign in Oct-2017. The furthest north point is the Loir headwater and the river uphill this point is non-permanent.

### CONCLUSION

The spatial pattern of nitrogen both as  $\text{NO}_3^-$  and dissolved  $\text{N}_2\text{O}$  seems to be conditioned by the geographical areas of the Haut Loir Watershed. Higher concentrations were measured in the water from the Beauce area, directly fed by the aquifer. A new campaign will be conducted in 2018 to strengthen these observations and to investigate deeply temporal variabilities of nitrogen in water that are different between the 3 investigated geographical areas.

**Acknowledgements:** we thank ADEME for funding this study through the HydroGES project. We also thank Adeline Ayzac, Lionel Cottenot, Christian Lelay, Didier Laloua for the help in field and lab work.

### REFERENCES

- CITEPA, 2014. Inventaire des émissions de polluants atmosphériques et de gaz à effet de serre en France – format SECTEN.
- Garnier, J., Billen, G., Vilain, G., Martinez, A., Silvestre, M., Mounier, E., Toche, F., 2009 Nitrous oxide ( $\text{N}_2\text{O}$ ) in the Seine river and basin: Observations and budgets, *Agriculture, Ecosystems and Environment* 133, 223-233.
- De Klein, C., Novoa, R. S. A., Ogle, S., Smith, K. A., Rochette, et al. 2006.  $\text{N}_2\text{O}$  Emissions from Managed Soils, and  $\text{CO}_2$  Emissions from Lime and Urea Application. Volume 4: Agriculture, Forestry and Other Land Use, 2006 IPCC Guidelines for National Greenhouse Gas Inventories, Intergovernmental Panel on Climate Change. Institute for Global Environmental Strategies: Hayama, Japan.

## **PLANT GROWTH INDICATES SOIL SPATIAL VARIABILITY RELATED TO WATER SHORTAGE AND NITRATE LEACHING VULNERABILITY**

HABERLE, J., SVOBODA, P., ŠIMON, T., LUKÁŠ, J., KUREŠOVÁ, G., KŘÍŽOVÁ, K. MADARAS, M.

Crop Research Institute, Prague, Czech Republic

### **INTRODUCTION**

The production of vegetables and potatoes shows low nitrogen use efficiency and it may be the source of excessive residual nitrate that is prone to leaching, especially under irrigation (Cameira, Mota 2017). Early potatoes and many vegetables demand great amount of readily available water and nitrogen in soil due to a shallow root system and lower absorption capacity. Main regions of irrigated early potatoes and vegetable production in the Czech Republic are situated along rivers, especially Labe, Jizera, and Morava. Fields are mostly light and medium soils with sandy, often stony subsoil, with a low water capacity and fast infiltration. The regions are also utilized for drinking water accumulation and extraction (Bruthans et al., 2015). The coexistence of the intensive agricultural production and water quality requirements is not easy. A typical example of resulting problems is found in the area along lower Jizera river. Water is extracted by over six hundreds of bore wells supplied by water seeping from the river and the percolation from near and farer fields (water works Káraný). Monitoring of vegetable and potatoes production and  $N_{\min}$  ( $\text{NO}_3\text{-N} + \text{NH}_4\text{-N}$ ) content down to 120 cm in the area showed high nitrate contents in deep subsoil layers (under) 60 cm, not accessible to the roots of many crops (Klír et al., 2017). This can be linked to the observed trend of increasing nitrate concentration in extracted water in the last 10 - 20 years. Soil vulnerability to leaching is amplified by a high spatial variability of soil properties which is manifested visually, by water stress impacts, when not irrigated crops are grown in the fields (Duffková et al. 2012).

The objective of research was to gather data on soil and plant spatial variability with standard methods and distant or indirect methods.

### **MATERIAL AND METHODS**

The four experimental fields, denoted as So1, So2, So3 and Ko1, near Sojovice (50.2139350N, 14.7571592E) and Kochánky villages (50.2757078N, 14.7926503E ) were monitored in year 2017. Experimental fields are adjacent to lines of collection wells. Grain pea (Ko1) and winter wheat (So1-3) were grown without irrigation. Soil and plants were sampled in 21 (Ko) and 32 (So) points selected according aerial photos from 2015 and/or 2016 dry years, to represent areas of different impact of drought on crops.  $N_{\min}$  and soil moisture was determined to depth of 90 cm in early Spring. The soil was also analyzed for nutrient content (K, P, Ca, Mg),  $C_{\text{ox}}$  and  $N_{\text{tot}}$  contents in top soil (0-30 cm) and shallow subsoil (30-60 cm) layers. Pedological survey of the fields was performed, soil samples taken to 90 cm were analyzed for soil texture classes, used for calculation of soil water capacity (FWC) with simple pedotransfer functions (Váša, 1960). Above-ground parts of pea and wheat were sampled during vegetative growth and before maturity. The contents of N,  $^{13}\text{C}$  and  $^{12}\text{C}$  in plants were determined with elementary analyzer EA 3200 (Eurovector, Italy) connected with isotope mass spectrometer Isoprime (GV Instruments, UK). RGB and thermal images were obtained during growth with drones.

### **RESULTS AND DISCUSSION**

The dry weather of year 2017 contributed to pronounced impact of soil variability on plants. Strong differences in plant height, growth, the time of onset and the severity of water stress, withering and drying were distinguishable at the scale of one meter and less. The results showed significant relationships between  $^{13}\text{C}$  discrimination, the indicator of water conditions during growth (e.g. Raimanová et al., 2016), and the impact of soil variability on wheat and pea growth and yield (Fig. 1).

As expected, significant relationships of various strength were found between plant growth, soil texture or FWC and  $\Delta^{13}\text{C}$ . The relationships with aerial data are being analyzed; preliminary results show good relations to plant growth and soil properties.

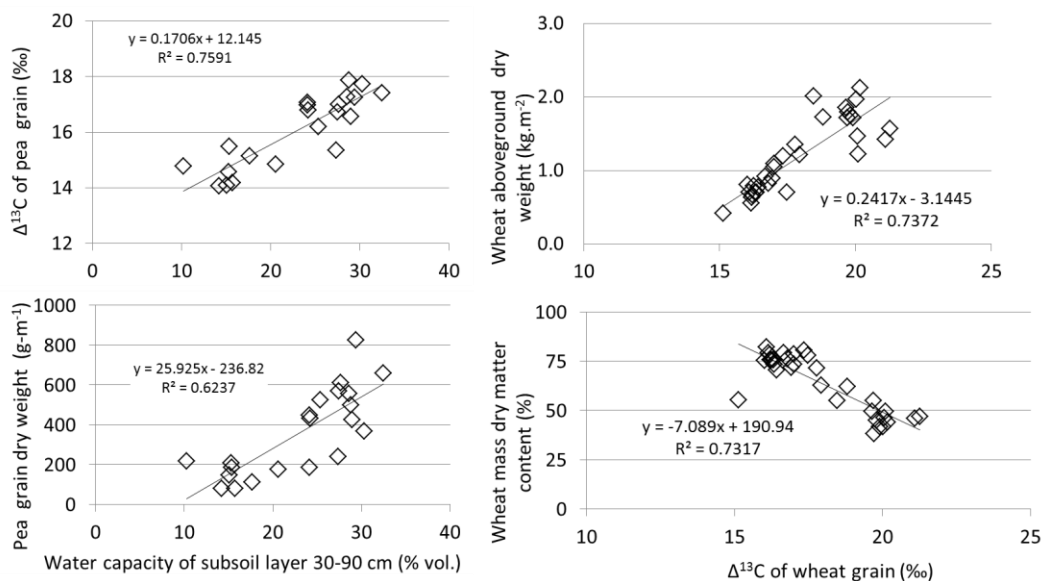

Figure 1. Relationship between wheat and pea seeds  $^{13}\text{C}$  discrimination, biomass and subsoil water capacity.

## CONCLUSION

The impact of water stress on plants reliably indicated spatially variable soil conditions related to soil vulnerability to water shortage and nitrate leaching.

**Acknowledgements:** Supported by Ministry of Agriculture of the Czech Republic CRI RO0418, Technology Agency of the Czech Republic TH02030133 and by Ministry of Industry and Trade TRIO FV10213.

## REFERENCES

- Bruthans J., Kadlecova R., Rybarova M., Hronec L., Kurkova I., Buzek F., 2015. High nitrate content in river bank filtration water supply in alluvial aquifer: Integrated approach, in 42nd IAH Congress - AQUA 2015, Rome, Italy (Abstract ID: 759).
- Cameira, M.R., Mota, M., 2017. Nitrogen Related Diffuse Pollution from Horticulture Production—Mitigation Practices and Assessment Strategies. *Horticulturae* 3, 25.
- Duffková D., Brom J., Žížala D., Zemek F., Procházka J., Nováková E., Zajíček A., Kvítek T., 2012. The determination of infiltration regions using water stress indices of vegetation from remote sensing and field measurement. *Certified Methods, VÚMOP, Praha 2012*. 64 pp. (In Czech). ISBN: 978-80-87361-15-3.
- Klír J., Šimon T., Svoboda P., Kurešová G., Haberle J. 2017. The distribution of mineral nitrogen in soil in relation to risk of nitrogen leaching in farms with irrigated vegetables, in: Dalgaard T., Olesen J.E., et al. (Eds), *Innovative solutions for sustainable management of Nitrogen*, Copenhagen, Aarhus University, June 2017, p. 79.
- Raimanová I., Svoboda P., Kurešová G., Haberle J., 2016. The effect of different post-anthesis water supply on the carbon isotope discrimination of winter wheat grain. *Plant, Soil & Environment*, 62 (7), 329-334.
- Váša J., 1960. Soil moisture characteristics (Půdní vláhové charakteristiky). *Vodohospodářský časopis SAV*, 8: 235- 243 (In Slovak).

## ASSESSMENT OF ARTIFICIAL WETLAND FOR NITRATE REMOVAL FROM SUBSURFACE DRAINED WATERSHED

TOURNEBIZE J.<sup>1</sup>, CHAUMONT C.<sup>1</sup>, BLANDIN M.<sup>1</sup>, SOOSAAR K.<sup>2</sup>, HANSEN R.<sup>2</sup>, MUHEL M.<sup>2</sup>, TEEMUSK A.<sup>2</sup>, PÄRN J.<sup>2</sup>, MANDER U.<sup>2</sup>

<sup>1</sup> Irstea, UR HYCAR, 1 Rue Pierre-Gilles de Gennes, CS 10030, F-92761 Antony Cedex, France, <sup>2</sup>University of Tartu, Institute of Ecology and Earth Sciences, 46 Vanemuise St, 51014 Tartu, Estonia

### INTRODUCTION

To reduce agricultural pollutants in drained watersheds, artificial wetlands showed a real potential as a mitigation strategy. Several publications have previously carried out experiments at plot scale to evaluate their efficacy, but few are dealing with the watershed scale. It is also the case that the long-term efficiency and greenhouse gas emission potential of these systems are poorly known. This study fills some of these gaps in our knowledge in this field.

### MATERIAL AND METHODS

An off-stream artificial wetland (5270 m<sup>2</sup>, 0.1 to 1 m deep), designed initially to abate pesticide pollution, intercepts drainage water from a 355 ha watershed in Rampillon, France (03°03'37.3" E, 48°32'16.7" N). A sluice gate at the inlet controls the rate of flow during peak events specially during winter season. The flow entering the wetland fluctuates from 0 to 120 L s<sup>-1</sup>. The wetland is partially colonised by sedges, reed, cattails and free floating phytoplankton. Since 2012, an automatic water quality monitoring system has measured water discharge, temperature, dissolved O<sub>2</sub>, conductivity pH, and NO<sub>3</sub><sup>-</sup> and DOC concentrations in both the inlet and outlet artificial wetland. High frequency monitoring (discharge with a waterflow probe based on Doppler principle and Nitrate concentration with a spectro UV device based on light adsorption at 253nm by nitrate ion, at an hourly time step), supported with weekly flow weighted samples to assess Nitrate flux removal between the INLET and OUTLET of the artificial wetland. In May and November 2014 and March, November 2015 one-week high frequency measurement campaigns were conducted to study N<sub>2</sub>O fluxes using 6 manually operated opaque floating static chambers and 12 floating automatic dynamic chambers (ADC). The latter were operated via multiplexer and had an incubation time of 5 minutes, whereas the gas flow was continuously measured using the Aerodyne TILDAS quantum cascade laser system. During the campaign, changes in the NO<sub>3</sub><sup>-</sup> concentration was measured in nine reactor pipes. Also, water samples were collected for N<sub>2</sub>O and N<sub>2</sub> isotope analysis, and sediments were collected for potential N<sub>2</sub> emission measurements using He/O<sub>2</sub> method.

### RESULTS AND DISCUSSION

#### Nitrate removal in drained water

The 5 years monitoring data for the INLET/OUTLET sampling points (table 1) showed contrasting hydrological season with cumulative drain flow ranging between 89 up to 269 mm/years. The INLET average concentrations were above 54 mg NO<sub>3</sub>.L<sup>-1</sup>, whereas OUTLET concentrations were 19% lower in average for the 5 year's period. The percentage of exceeding threshold 50mg/L time is reduced from 45% to 17% due to artificial wetland mitigation. Mitigation efficiency due to denitrification processes accounting for the removal of about 24% of Nitrate fluxes from INLET to OUTLET of the experimental artificial wetland. Looking in detail the time series' removal efficiency is strongly dependent to hydraulic residential time and water temperature. However, nitrate removal was evidence in the datasets over all flow periods.

Table 1. Summary of monitored data and calculated fluxes for the period 2012 to 2017

Hydrological Year (from N/10/01 to N+1/09/30)	2012-13	2013-14	2014-15	2015-16	2016-17
Rainfall (mm)	790	921	652	869	692
Reference Evapotranspiration (mm)	595	621	734	638	730
Average Temperature during drained flow period (°C)	12.6	15.3	10.8	10.6	10.7
Drained Flow (mm)	269	225	192	199	89
Intercepted Volume by Artificial Wetland (mm)	25	19	120	94	29
Intercepted Rate of total drained flow (%)	9%	8%	63%	47%	33%
Flow weight INLET Nitrate concentration (mgNO <sub>3</sub> .L <sup>-1</sup> )	60.6	54.5	57.6	65.7	70.7
Flow weight OUTLET Nitrate concentration (mgNO <sub>3</sub> .L <sup>-1</sup> )	46.1	39.4	52.3	57.2	55.9
% Nitrate removal (%)	31.4	38.5	10.2	14.9	26.4
Over 50mg/L Nitrate concentration frequency INLET (%)	55%	NC	55%	32%	37%
Over 50mg/L Nitrate concentration frequency OUTLET (%)	15%	8%	27%	10%	27%
Yearly average Nitrate removal rate (mgN-NO <sub>3</sub> .day <sup>-1</sup> .m <sup>-2</sup> )	269	207	441	254	270

### N<sub>2</sub>O emission from artificial wetland

Measured N<sub>2</sub>O emissions were low with an average of 1.1 µg N<sub>2</sub>O-N.m<sup>-2</sup>.h<sup>-1</sup>, ranging from -25 to 62.8 µg N<sub>2</sub>O-N.m<sup>-2</sup>.h<sup>-1</sup>. Extrapolated fluxes of N<sub>2</sub>O were not significant at artificial wetland with less than 0.3 kg N-N<sub>2</sub>O emitted over 312kgN-NO<sub>3</sub> removed (<0.1%).

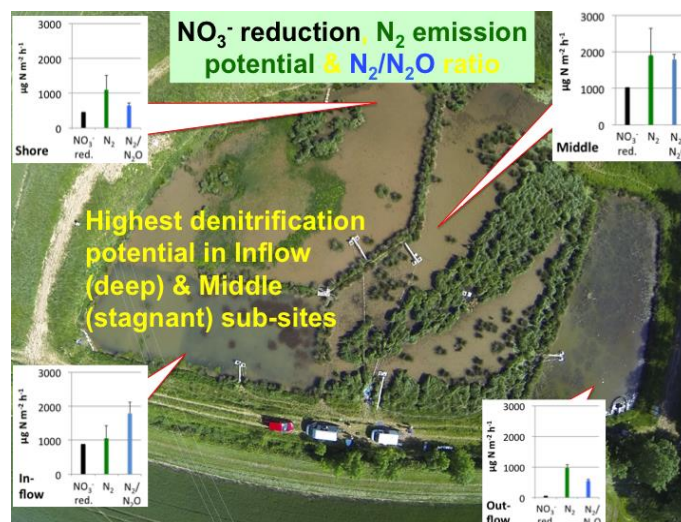

Figure 1. N<sub>2</sub> and N<sub>2</sub>O emissions from sediment incubation.

### CONCLUSION

The Nitrate removal potential of artificial wetlands is clear, including high efficiency variability during the season due to hydraulic residential time and temperature. Denitrification is the main process involved, without significant N<sub>2</sub>O emissions (less than 0.1% of removed Nitrate). A modelling approach based on the Tank In Series concept allows extrapolation of Rampillon's results and supports a design tool recommending a ratio between restored artificial wetland over connected drained area of 1% to remove 40% of annual Nitrate coming drained agricultural watershed.

## EVALUATING SCENARIOS OF LAND MANAGEMENT PRACTICES IN CONTRASTED LANDSCAPES USING A NITROGEN LANDSCAPE MODEL

CASAL L. <sup>1</sup>; DURAND P. <sup>1\*</sup>; AKKAL-CORFINI N. <sup>1</sup>; BENHAMOU C. <sup>2</sup>; SALMON-MONVIOLA J. <sup>1</sup>; FERRANT S. <sup>3</sup>; PROBST A. <sup>5</sup>; PROBST J.L. <sup>4</sup>; SAUVAGE S. <sup>4</sup>; VERTES F. <sup>1</sup>

<sup>1</sup> UMR SAS, AGROCAMPUS OUEST, INRA 35000 Rennes, France; <sup>2</sup> UMR ECOSYS, AgroParisTech, INRA 78850 Thiverval-Grignon, France; <sup>3</sup> Centre National d'Etudes Spatiales (CNES), CESBIO, F-31000 Toulouse, France; <sup>4</sup> ECOLAB, Université de Toulouse, CNRS, INPT, UPS, France

### INTRODUCTION

Designing mitigation strategies at the landscape scale to improve overall N efficiency and reduce undesirable emissions is a major challenge (Cellier et al., 2011). Most often, mitigation measures are conceived at field or farm scale to reduce one main type of N emission. As part of the ESCAPADE project (ANR-12-AGRO-0003), agri-environmental scenarios of N management were built in contrasted rural landscapes to better understand the way reactive nitrogen transforms and transfers into, out of and within the agro-ecosystem (Galloway et al., 2003) depending on farm management and landscaping. The main objectives were (1) to simulate spatio-temporal scenarios under different environmental and agricultural conditions using the TNT2 model and (2) to evaluate the relative efficiency and possible complementarity of field-oriented and landscape-oriented measures to reduce N emissions in contrasted landscapes.

### MATERIAL AND METHODS

The two study sites are headwater catchments located in Kervidy-Naizin (Western France) and in Auradé (South-West of France). They are contrasted in terms of agriculture type (mix farming with high livestock density and cereal cropping, respectively), soil, and landscape structures. Surveys were held to describe agricultural practices exhaustively (crop rotations and crop management practices over 15 years). The scenarios were built to investigate the different ways of mitigating the nitrogen cascade 1) optimization of agricultural practices (BMP scenarios), 2) management of landscape structure according to two strategies: (i) riparian buffer installation (ie distributing ecological structures such as vegetated/forested buffer strips around major sources or in riparian position in the landscape RI\_scenarios), and (ii) set-aside patches (implanting few patches of natural vegetation HD\_scenarios). Control scenario 0\_N aimed at estimating the N legacy of the catchment and the time lag necessary to go back to nearly pristine conditions. The scenarios are simulated using TNT2, a spatially distributed agro-hydrological model focusing on the spatial interactions within the landscape (Beaujouan et al., 2002; Ferrant et al., 2013; Oehler et al., 2009).

### RESULTS AND DISCUSSION

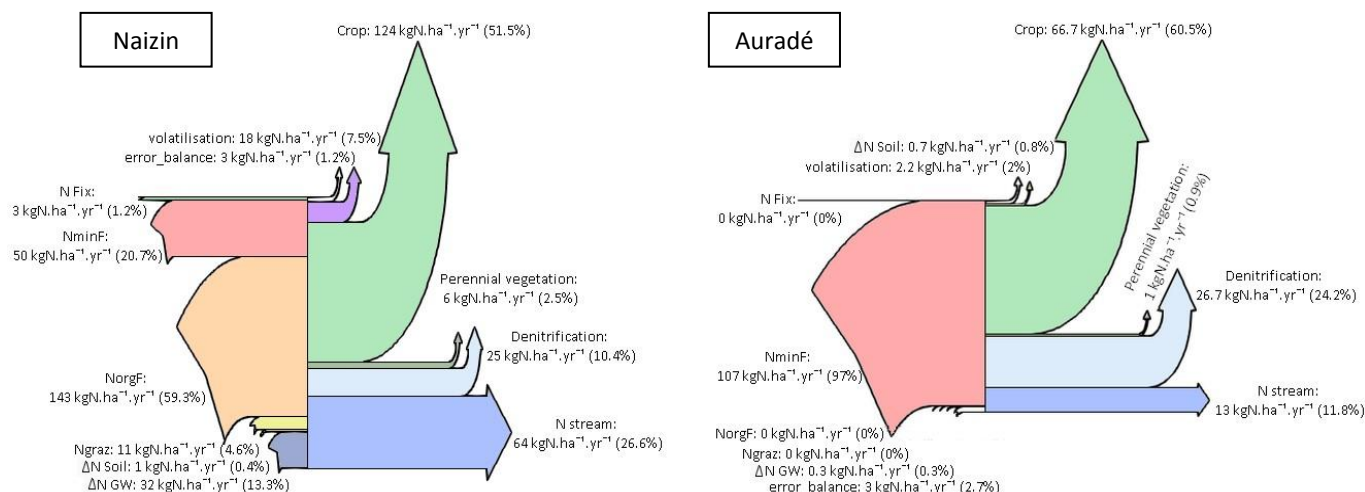

Figure 1. Nitrogen mass balance at the catchment scale for the last three hydrologic years of simulation from 2012 to 2015.



The figure 1 highlights the differences of the nitrogen mass balance between these contrasted sites. Auradé has a N surplus half of that of Kervidy-Naizin (40 and 83 kgN/ha/year, respectively). The diverse N inputs (organic, mineral inputs and grazing) in Naizin site generates a lossy nitrogen management enhanced by the high density of livestock and the wetter climate (runoff of 340 mm vs 100 mm in Auradé). The inputs on Auradé site are mineral fertilizers only. As a result the losses in the stream are only 13 in Auradé vs 64 kgN.ha<sup>-1</sup>.year<sup>-1</sup> in Kervidy-Naizin.

Table 1: (a) Main features of the set of scenarios with N\_sc for Kervidy-Naizin and Au\_sc for Auradé site (the units are specified in brackets) and (b) corresponding results. The concentration is in mgN-NO<sub>3</sub>.L<sup>-1</sup>, N input is in kgN.ha<sup>-1</sup>.year<sup>-1</sup> and N excess is a dimensionless ratio.

	N_BAU	N_BMP	N_HD14	N_RI14	N_ON	Au_BAU	Au_BMP	Au_HD18	Au_RI18	Au_ON
<b>a. Scenarios</b>										
Fertiliser reduction (%)	0	9	23	19	100	0	6	28	13	100
Uncut grassland (%)	5	5	16	15	100	4	4	18	18	100
<b>b. Results - Fluxes (average of 3 last years)</b>										
NO <sub>3</sub> -N concentration	15.2	14.1	13.6	11.7	9	8.8	8.6	7.6	8.1	4.4
N input by agriculture	207	188	160	168	0	107	100	79	93	0
N excess	83	68	45	46	-94	40	38	24	33	-24

The results show that on both sites, scenarios rank in the same way BAU > BMP > HD > RI > ON. However, the scenarios have different efficiencies according to the sites. The control scenario ON (zero input and 100% grassland) represents a decrease in stream concentration of 50 % in Auradé vs. 41 % in Kervidy-Naizin compared to Business as usual scenario (BAU). The scenarios of landscape management are more efficient in Kervidy-Naizin with a decrease of 11 % and 23% ((BAU-sc)/BAU) for HD and RI scenarios, respectively, while in Auradé the decrease is only 8 % and 14 %, respectively, although the surface converted in environmental zone is larger in Auradé (18%) than in Naizin (16 %).

## CONCLUSION

This study shows the interest of distributed modelling to compare contrasted sites. Assessing the effect on the gaseous emissions and deposition of ammonia and the indirect N<sub>2</sub>O emissions should be the next step for better assessment of these scenarios. More generally, these types of landuse management are also potentially beneficial for the mitigation of other pollutant and for preservation of biodiversity. This suggests that such policy should be submitted to a multicriteria evaluation, in terms of ecosystem services and economic impacts taking into account the agricultural and pedoclimatic context of the catchments.

**Acknowledgements:** This work was funded by the French National Research Agency (ESCAPADE project ANR-12-AGRO-0003). For Naizin-Kervidy, the farm surveys were performed within the MOSAIC project ANR-12-AGRO-0005). The grant of the 1st author was co-funded by Arvalis. The two experimental catchments, Kervidy-Naizin and Auradé, belong to the French Research Infrastructure OZCAR (Observatory of the Critical Zone: <http://www.ozcar-ri.org/>).

## REFERENCES

- Beaujouan V, Durand P, Ruiz L, Aurousseau P, Cotteret G. A hydrological model dedicated to topography-based simulation of nitrogen transfer and transformation: rationale and application to the geomorphology-denitrification relationship. *Hydrological Processes* 2002; 16: 493-507.
- Cellier P, Durand P, Hutchings N, Dragosits U, Theobald M, Drouet JL, et al. Nitrogen flows and fate in rural landscapes. In: Sutton, M. A., Howard, C. M., Erisman, J. W., Billen, G., Bleeker, A., Grennfelt, P., van Grinsven, H., Grizzetti, B., (eds.) *The European Nitrogen Assessment Sources, Effects and Policy Perspectives*. Cambridge University Press 2011: 229-248.
- Ferrant S, Durand P, Justes E, Probst J-L, Sanchez-Perez J-M. Simulating the long term impact of nitrate mitigation scenarios in a pilot study basin. *Agricultural Water Management* 2013; 124: 85-

96.

Galloway JN, Aber JD, Erisman JW, Seitzinger SP, Howarth RW, Cowling EB, et al. The nitrogen cascade. *BioScience* 2003; 53: 341–356.

Oehler F, Durand P, Bordenave P, Saadi Z, Salmon-Monviola J. Modelling denitrification at the catchment scale. . *Science of the Total Environment* 2009; 407: 1726-1737.

## **N<sub>2</sub>O EMISSIONS IN RESPONSE TO THE ADDITION OF NITRIFICATION INHIBITORS TO DIGESTATE: A CASE STUDY IN THE PO VALLEY (NORTHERN ITALY)**

CHIODINI, M.E.<sup>1</sup>, PEREGO, A.<sup>1</sup>, SANZ-GOMEZ, J.<sup>2</sup>, TARLAZZI, S.<sup>3</sup> ACUTIS, M.<sup>1</sup>,

<sup>1</sup>Department of Agricultural and Environmental Sciences, University of Milano, via Celoria, Italy, <sup>2</sup> BASF SE, 3BASf Italy Crop Protection Division

### **INTRODUCTION**

Agricultural soils are the main anthropogenic source of nitrous oxide (N<sub>2</sub>O) and its emission is related to fertiliser-N, particularly in over-fertilized systems (Shcherbak et al., 2014). Addition of nitrification inhibitors, such as 3,4-dimethylpyrazolophosphate (DMPP), to ammonium-based fertilizers was shown to decrease N<sub>2</sub>O emissions (Severin et al., 2016). The aim of this study was to estimate the effect of a DMPP-base product (BASF commercial name: Vizura<sup>®</sup>) added to digestate in decreasing the N<sub>2</sub>O emission in a field site in the Po valley (Northern Italy). This area is characterized by high temperature in summer and in turn high rate of nitrification, along with large fertilization rate and irrigation water availability (Perego et al., 2016).

### **MATERIAL AND METHODS**

The N<sub>2</sub>O emissions were observed in two monitoring campaigns (each 5 weeks long, sampling every 2 days) in a field located in Valera Fratta (45°15'N 9°20'E, Soil organic carbon=1.3%, June-August mean air temperature=25°C) after top-dressing fertilization in maize in 2016 and prior to maize sowing in 2017. Compared treatments were: non-fertilized plot (N0), D: digestate - Vizura<sup>®</sup> injection, V: digestate + Vizura<sup>®</sup> injection. Digestate derived from silage maize + dairy slurry anaerobic digestion. The fertilization rate in 2016 was 61 kg N ha<sup>-1</sup>; it was 283 kg N ha<sup>-1</sup> in 2017. In V, Vizura<sup>®</sup> (2 l ha<sup>-1</sup>) was injected in the topsoil (0-0.20 m).

For each treatment and each sampling day, three non-static chambers (NSCs, made of polypropylene, thermally insulated, 0.3 m long X 0.3 m wide X 0.3 m height) were used in order to collect replicates. NSCs were built according to Chadwick et al. (2014). The samples were taken by a syringe through a tube and valve having a Luer Lock system for the connection. For each sampling date and NSC, samples were taken at 0, 20 and 40 minutes after the installation of the NSC on the framework placed in the topsoil. Before taking the sample, the fan system was run for 10 seconds in order to accurately mixing the air into the NSC. Then 30 ml of inner air was collected by 60 ml syringe and then put into 12 ml under vacuum LabcoExetainer<sup>®</sup> glass vials.

As for the flux determination, we used the linear regression method wherein N<sub>2</sub>O fluxes for each NSC was calculated as follows:  $F = H \cdot dC/dt$ , where F is flux ( $\mu\text{g m}^{-2}\text{s}^{-1}$ ); H is the ratio of the internal NSC volume ( $\text{m}^3$ ) over the surface area ( $\text{m}^2$ ) in contact with the soil; C is the N<sub>2</sub>O concentration in the NSC ( $\mu\text{g m}^{-3}$ ); t is time (seconds); dC/dt is used to represent the time rate of change of C ( $\mu\text{g m}^{-3} \text{s}^{-1}$ ). Cumulated fluxes were calculated by the estimation of missing data through linear interpolation between the mean fluxes obtained by samples on successive sampling date. In order to define the standard deviation of cumulated fluxes (dotted lines in Fig. 1) a bootstrap based method using IBM SPSS 24 statistical software was applied.

### **RESULTS AND discussion**

Both in 2016 and 2017, results demonstrate that the addition of Vizura<sup>®</sup> to the digestate significantly reduce the cumulative N<sub>2</sub>O emissions. As shown in Figure 1, similar emission trends were observed over the experiments. In 2016, when an irrigation event occurred (about 30 mm; 20 days after injection), V did not result in an increase in emissions unlike it was found in D. Similarly, in 2017 the irrigation water, which was applied the day after the injection, caused a rapidly increase in N<sub>2</sub>O emission in D unlike in V. Moreover, the inhibition effect was still present at the end of the experiment. The N<sub>2</sub>O emissions were 50% and 81% lower in V than in D in 2016 and 2017, respectively. The emission

factor estimated for V was comparable to the IPCC value (1%; Tab.1). Our results of reduction are in agreement with Severin et al. (2016).

Figure 1. Cumulative  $N_2O-N$  observed in 2016 and 2017 monitoring campaigns. NO: non-fertilized plot, D: digestate - Vizura® injection, V: digestate + Vizura® injection; continuous lines indicate mean emissions values; dotted lines indicate  $\pm 1 \sigma$  values.

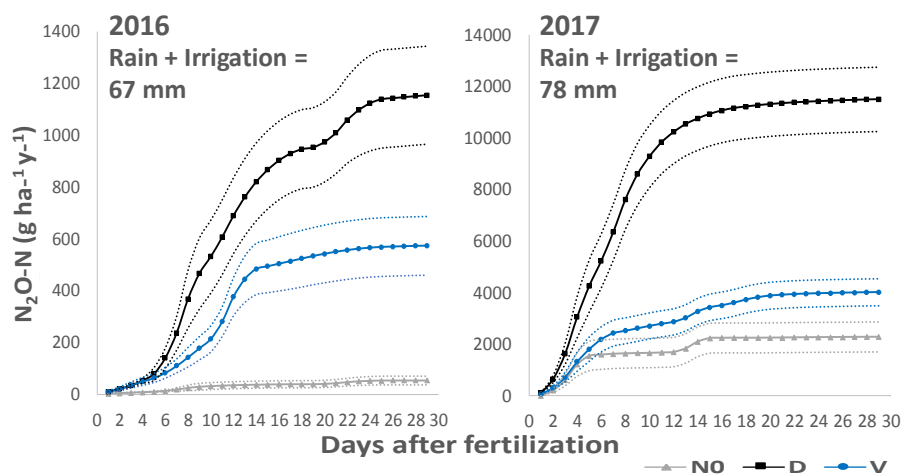

Table 1. Cumulative  $N_2O$  emission and EF factor (in % of N applied, subtracted by emissions from NO) of digestate - Vizura® (D) and digestate + Vizura® (V) treatments in 2016 and 2017.

Year	Treatment	Application method	Total N supplied (kg N ha <sup>-1</sup> )	TAN supplied (kg NH <sub>4</sub> -N ha <sup>-1</sup> )	N emitted (N <sub>2</sub> O-N kg ha <sup>-1</sup> )	EF (%)
2016	D	Inter-row injection	61	27.8	1.10	1.8%
	V				0.52	0.9%
2017	D	Tines harrow injection	238	167.5	9.22	3.9%
	V				1.73	0.7%

## Conclusion

The addition of the DMPP inhibitors to digestate significantly reduced cumulative  $N_2O$  emissions from maize under the climatic conditions of the Po valley.

**Acknowledgements:** We acknowledge BASF Italy Crop Protection Division for generous provision of Vizura..

## REFERENCES

- Chadwick D.R., Cardenas L., Misselbrook T.H., Smith K.A., Rees R.M., Watson C.J., Dhanoa M.S., 2014. Optimizing chamber methods for measuring nitrous oxide emissions from plot-based agricultural experiments. *Eur. J. Soil Sci.*, 65-2, 295–307.
- Perego A., Wu L., Finco A., Gerosa G., Chiazzese M., Amaducci S., 2016. Field evaluation combined with modelling analysis to study fertilizer and tillage as factors affecting  $N_2O$  emissions: A case study in the Po valley (Northern Italy). *Agric. Ecosys. Environ.*, 225, 72-85.
- Shcherbak, I., Millar, N., & Robertson, G.P., 2014. Global metaanalysis of the nonlinear response of soil nitrous oxide ( $N_2O$ ) emissions to fertilizer nitrogen. *PNAS*, 111-25, 9199-9204.
- Severin M., Fuß R., Well R., Hähndel R., Van den Weghe H., 2016. Greenhouse gas emissions after application of digestate: short-term effects of nitrification inhibitor and application technique effects. *Arch. Agron. Soil Sci.*, 62-7, 1007–1020.

## **CHANGES IN LAND USE AND IMPACT IN WATER QUALITY FOR WATER SUPPLY. EXAMPLE OF “CASTELO DE BODE” IN PORTUGAL**

CORDOVIL, C.M.d.S.<sup>1</sup>, REIS, R.<sup>2</sup>, MIRANDA, R. <sup>1</sup>; VALE, M.<sup>2</sup>

<sup>1</sup> Universidade de Lisboa, Instituto Superior de Agronomia LEAF, Portugal; <sup>2</sup> Direcção Geral do Território, Portugal

### **INTRODUCTION**

Territory management is closely linked to water management. Portugal has recently made a legislative revision of the land planning and territorial management policy. In this work we review the conceptual strategies defined for the efficient management of the territory and water resources, based on the work experience of two decades acquired on the sub-basin of “Castelo do Bode”, to make an analysis of the transformations of land use, integrating the changes induced by the recent fires in the year 2017 which had a substantial risk impact on the decline of the raw water quality. A retrospective analysis of the evolution of the territorial occupation of the drainage basin is made for the official water supply facility (EPAL) in “Castelo de Bode”. At the same time, the evolution of water quality parameters, in particular those associated with quality monitoring, is evaluated, with emphasis on the behavior of nitrogen and phosphorus. At the same time, and because the Portuguese mainland suffered in 2017 the most serious fires with more than 400 thousand hectares of burned area, we try to integrate in the analysis the phenomenon of fires and their impact on water quality. This risk of deterioration of the quality of the supercritical water is associated with the increase in the surface runoff, which carries with it the burning materials containing nutrients such as nitrogen and phosphorus and other elements whose excessive presence in the water is undesirable. The basin under study has undergone changes of use over the years with the consequent impacts on soil in terms of organic matter and its physical characteristics, namely drainage, which directly affects the quality of surface and groundwater. In this process of deterioration of quality, nitrogen (N) and phosphorus (P) are particularly important, two essential nutrients for agricultural production, but with special attention to their impact on water quality.

### **DRIVERS AND IMPACTS**

The adverse effects of forest fires have a variable impact on the various environmental compartments: soil, water, air and biota. Fire intensity is directly related to the impacts caused on the environment. A low-intensity fire can raise the surface temperature of the soil up to 100 °C and a temperature of 50 °C can be recorded at 5 cm depth. If the fire is of high intensity, then the temperature of the soil surface can reach 700 °C, and a temperature of 250 °C can be found at 10 cm depth (Neary et al., 1999). One of the consequences of forest fires may be the loss of soil organic matter (SOM). In fact, the volatilization of organic compounds starts at 100 to 180 °C and at 200 °C the decomposition of resistant compounds such as hemicellulose and lignin occurs. Forest fires can also result in structural changes in SOM, with their consequences in the lower retention of elements by soil colloids. These elements include both nutrients such as nitrogen and phosphorus, such as micronutrients and metals which, downstream can reach surface water by runoff or groundwater by leaching. However, fires also contribute to the entry of organic material from partially burnt materials which in the long term may even result in increased accumulation of OM in soils due to mineralization deficiency. Irrespective of fire intensity, there is a significant increase of N-NH<sub>4</sub>, with consequent loss of N by volatilization and, if the conditions favor nitrification, loss of nitrates by leaching. This increase in N-NH<sub>4</sub> is mainly due to the increase number of dead plants and microbial biomass. In fact, another consequence of forest fires is the impact of temperature on soil microorganisms, which can be killed between 50 and 120 °C (Silva et al., 2016). Microbial biomass can even be completely destroyed in the surface layer of the soil and take many years to recover pre-fire levels. In this context, where both SOM and microbial biomass have been totally or partially destroyed, soil disruption necessarily leads to a reduction in its capacity for adsorption and water infiltration. After a fire occurs, a hydrophobic layer is formed in the soil and changes the porosity, the infiltration capacity and the water storage, as a consequence of the structural

changes occurred. In fact, the absence of vegetation, and the newly acquired depletion of the soil structure, greatly promotes erosion which, following the natural drainage trend of the basins, leads to varying amounts of nutrients in the surface water bodies (eg N and P) and organic compounds from the ashes formed by the vegetal material consumed by the fire. Not only is SOM and its mineralized elements lost, but also the organic compounds resulting from the burning of woody species will, in time, supply more mineral elements that can potentially reach the water bodies, thus increasing their pollution. Of particular note are nitrogen, phosphorus, micronutrients and metals, as well as organic compounds, for example polycyclic aromatic compounds (Silva et al., 2016). The most notable effect of the fires is on the level of the flora, by the partial or complete alteration or elimination of the vegetation (dead blanket, arboreal and shrub vegetation). As a result of the loss of vegetation, the soil is more exposed and with a greater vulnerability to the erosive processes, namely water erosion type in the first rains after the fire. The hydrological regime is also affected indirectly by changes in vegetation and soil level, with lower evaporation and higher volumes of surface runoff in burned areas compared to non-burned areas (Silva et al., 2016). Once again, this impact will determine and favor the nutrient runoff among which N and P stand out. In fact, forest fires should be seen as a source of diffuse pollution for bodies of water downstream of. In the present work, it is possible to determine the presence of the compounds of the present invention. These substances, from certain concentrations, present high toxicity to living beings, and have a potential for bioaccumulation and high environmental persistence (Silva et al., 2016). All pyrolytic substances, which also include N and P nutrients, can reach aquatic systems downstream from the burned areas, through surface run-offs (other means of transport include leaching and atmospheric deposition), compromising water quality and affecting the aquatic biota (Silva et al., 2016). For example, particular groups such as phytoplankton, amphibians and fish. However, re-vegetation of burned areas occurs spontaneously, but steps should be taken to promote plant growth to protect soils from the increased risk of erosion following a fire, with the negative consequences on water quality noted above. Promoting the recovery of the vegetation cover, which may include shrubby and woody herbaceous plants, necessarily requires restructuring of the soil, which necessarily implies the restoration of organic matter levels in the soil through conservation practices. A recommended practice for a shorter-term recovery may be the use of organic waste, which does not represent an increased risk of contamination of soil and water, to promote the increase of soil organic matter and provide nutrients to growing species (Cordovil et al., 2011).

## CONCLUSION

Taking into account future climate change scenarios, which provide for a longer dry season and an increase in extreme summer temperatures, forest fires are expected to increase, with obvious damage and levels. Thus, it is imperative to correctly evaluate the effects of forest fires on aquatic systems as they may be responsible for drastic and immediate changes in the structure and functioning of ecosystems.

**Acknowledgements:** Authors thank the NitroPortugal, H2020-TWINN-2015, a Coordination & support action n. 692331 project for funding. We also thank the Portuguese Science Foundation for funding the R&D Unit LEAF.

## REFERENCES

- Cordovil CMdS, A. de Varennes, R. Pinto, RC Fernandes 2011. Changes in mineral nitrogen, soil organic matter fractions and microbial community level physiological profiles after application of digested pig slurry and compost from municipal organic wastes to burned soils.  
DOI: 10.1016/j.soilbio.2010.12.023
- Neary, D.G., Klopatek, C.C., DeBano, L.F., Folliot, P.F., 1999. Fire effects on belowground sustainability: a review and synthesis. *Forest Ecol Manag.* 122, 51-71.
- Silva V, Pereira JL, Gonçalves F, Keizer IJ, Abrantes N 2016. Efeitos dos fogos florestais nos sistemas aquáticos. *Captar* 6(2), 68-77.

## **EUTROPHICATION: CAUSES, MECHANISMS, CONSEQUENCES AND PREDICTABILITY**

PINAY, G.<sup>1</sup>, GASCUEL-ODOUX, C.<sup>2</sup>, MENESGUEN, A.<sup>3</sup>, SOUCHON, Y.<sup>4</sup>, LE MOAL, M.<sup>5</sup>, DURAND, P.<sup>2</sup>,  
LEVAIN, A.<sup>6</sup>, PANNARD, A.<sup>1</sup>, SOUCHU, P.<sup>3</sup>, ETRILLARD, C.<sup>7</sup>, MOATAR, F.<sup>8</sup>.

<sup>1</sup> CNRS, Univ. Rennes 1, UMR Ecobio, Rennes, <sup>2</sup> Inra, UMR SAS, Rennes, <sup>3</sup> Ifremer, Brest, <sup>4</sup> Irstea UR Riverly Lyon, <sup>5</sup> CNRS, Rennes, <sup>6</sup> Inra, UMR Lisis, Marne la Vallée, <sup>7</sup> Inra, UMR SMART, Rennes, <sup>8</sup> Univ. Tours. France.

### **INTRODUCTION**

Eutrophication is one of the most common alterations of inland and marine waters. Its best-known manifestations are toxic cyanobacteria blooms in lakes and waterways and proliferations of green macroalgae in coastal areas. These phenomena are generating major disruptions to aquatic ecosystems and have impacts on related goods and services, on human health and on the economic activities of the territories where they occur. In some areas, these environmental crises have become an urgent societal issue, involving a wide variety of stakeholders with contrasting values and interests. The term eutrophication is used by both the scientific community and public policy-makers, and therefore has multiple definitions. The introduction by the public authorities of regulations to limit eutrophication is a source of tension and debate on the activities identified as contributing or having contributed decisively to these phenomena.

Debates on the identification of the factors and risk levels of eutrophication, seeking to guide public policies, have led the ministries in charge of the environment and agriculture to ask for a joint scientific appraisal (Expertise Scientifique Collective, or ESCo) to be conducted on the subject. French research institute (CNRS, Ifremer, INRA and Irstea) were therefore mandated to produce a critical situational analysis on the latest knowledge of the causes, mechanisms, consequences and predictability of eutrophication phenomena.

### **ORGANIZATION AND PRINCIPLES OF THE JOINT SCIENTIFIC APPRAISAL**

40 French and foreign experts were mobilized for the joint scientific appraisal on eutrophication, with skills in the following disciplines: ecology, hydrology, biogeochemistry, biotechnical sciences, social sciences, law, economics, and covering the various types of aquatic ecosystems: lakes, streams, estuaries, marine coastal and offshore environment, as well as the concept of continuum between these systems. The experts' work drew on a bibliographic corpus of around 4,000 references, composed essentially of scientific articles validated by peers, and supplemented, for a number of topics, by technical or scientific reports and legal texts. This exercise culminated with the production of a report compiling the experts' contributions, a synthesis, as well as a symposium, on September 19th, 2017..

### **CONTENTS OF THE REPORT**

1. What is eutrophication? Why and how does it occur?
  - 1.1. Definition of eutrophication
  - 1.2. What are the factors responsible for eutrophication?
  - 1.3. What are the mechanisms of eutrophication?
  - 1.4. What are the manifestations of eutrophication?
  - 1.5. What are the environmental, economic and social impacts inventoried?
2. What criteria can one use to characterize the eutrophication of environments?

Indicators of eutrophication are generally classified into indicators of pressure, chemical status and impact. Pressure and status indicators relate respectively to the identification and quantification of pollutant sources and their concentrations, whereas the impact indicators use the biological responses of the living communities specific to each type of environment.

4. Can the risk of eutrophication be characterized and predicted? If so, how?
  - 4.1. Transfers, retention and transformation of nitrogen and phosphorus along the land-sea continuum
  - 4.2. Taking account of climate change is essential
  - 4.3. The vulnerability of ecosystems to eutrophication
  - 4.4. Modelling: a tool for understanding ecosystems
  
5. What are the strategies and frameworks to combat eutrophication?
  - 5.1. Engineering in aquatic ecosystems: an ad hoc solution
  - 5.2. Managing phosphorus and nitrogen inputs in aquatic environments is essential
  - 5.3. Are regulatory monitoring frameworks well adapted to monitor eutrophication?
  - 5.4. Socio-economic support for remediation
  
6. Future areas of investigation
  - 6.1. Developing a methodology for analyzing the eutrophication risk
  - 6.2. Moving towards systemic research approaches

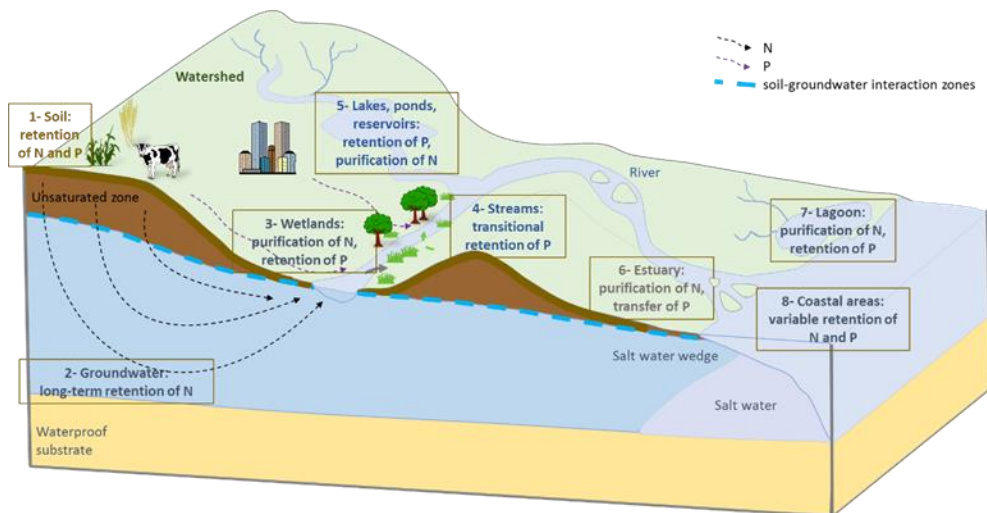

Figure 1. Conceptual diagram of the transfer, retention, and purification zones of nitrogen (N) and phosphorus (P) along the land-sea continuum. Source: Joint scientific appraisal on eutrophication.

## CONCLUSION

the synthesis, report, and presentation of the results symposium are available here: [www.cnrs.fr/inee](http://www.cnrs.fr/inee)

## REFERENCE

Gilles Pinay, Chantal Gascuel, Alain Ménesguen, Yves Souchon, Morgane Le Moal, Alix Levain, Alexandrine Pannard, Philippe Souchu, Claire Etrillard, Florentina Moatar. L'eutrophisation: manifestations, causes, conséquences et prédictibilité. Expertise scientifique collective, rapport, CNRS- Ifremer-INRA-Irstea (France), 148 pages (French and English versions).



# 20<sup>th</sup> Nitrogen Workshop

## Coupling C-N-P-S cycles

June 25-27, 2018

Le Couvent des Jacobins, Rennes – France

### **Session II: Regional studies – Oral presentations**

## **KEYNOTE PRESENTATION: NITROGEN DYNAMICS IN AGRICULTURAL SYSTEMS UNDER MEDITERRANEAN CLIMATE**

LUIS LASSALETTA

CEIGRAM, Universidad Politécnica de Madrid, Spain; IMBE-CNRS, Aix en Provence, France

The Mediterranean climate is characterized by having dry and warm summers and mild winters. It is found in some areas between 30° and 40° both in the North and South hemisphere. About 50% of the area is found in the countries of the Mediterranean basin, the rest is distributed in California (USA), Chile, South Africa and Australia. The study of agronomic and environmental sustainability of Mediterranean agricultural systems is of particular interest because: 1) it is present in highly populated areas; 2) it is a biodiversity hotspot; 3) the agriculture is unique in terms of species and varieties; 4) population increases and dietary changes are increasing the food demand; 5) the scarce water is a key production factor for agriculture but also a first necessity for the people; 6) climate change is exacerbating the most extreme Mediterranean traits; 7) some temperate areas in Europe and South America are experiencing transitions towards the Mediterranean climate. The role of nitrogen is central because it is a key production factor highly linked with water management and it is also a source of water pollution. Herein a summary is presented on the particular characteristics of nitrogen dynamics in agricultural systems that make the Mediterranean region different to other more studied areas such as the temperate one (e.g. North Europe). The agronomic and environmental implications of these particularities together with their connection with the configuration of the agro-food systems are discussed.

The temporal gap between the period of maximum water availability and of maximum irradiance has a deep impact on the configuration of the Mediterranean agricultural systems such as the selection of species, varieties, rotations and management practices (Aguilera et al. 2013). The response of crops to irrigation is disproportionately higher than in the countries with temperate climate (e.g. net irrigation requirements range 1000-2500 mm/y in Southern Europe, while in Denmark they are only 50 mm/y, Wriedt et al. 2009). As a consequence, the agricultural surface under irrigation has significantly grown in the Southern European countries during the last 30 years. The differences between these two worlds, namely rainfed and irrigated, are enormous and they have to be considered separately. Since the potential yields are much higher in irrigated crops, their fertilization is generally higher. Anyhow, the N input in irrigated systems is in many cases lower than in Northern Europe countries where the environmental conditions permit higher yields. The Yield vs. N Input response curves are very different when comparing rainfed and irrigated systems. Anyhow, there is also a diversity of Mediterranean climatic conditions from arid to humid and the maximum potential yield of rainfed systems is much closer to irrigated systems in the humid Mediterranean areas. The important climatic interannual variability clearly modulates the optimal N rate in rainfed systems. Thus, pollution risk and N management require taking into account the important effect of: 1) the spatial variability; 2) the interannual variability; 3) the significant water-nitrogen interactions (Quemada and Gabriel 2016).

To avoid the emissions of reactive nitrogen compounds such as ammonia, nitrous oxide and nitrate the recipes coming from studies performed in the temperate areas are not valid. Ammonia emissions associated with urea applications are in many cases lower due to higher atmospheric stability during the dry summers. The emission of ammonia is however becoming a first order problem in some Mediterranean countries due to structural changes occurred during the last decades in the agro-food system configuration, as the net import of feed is reaching similar levels to domestic crop production (Lassaletta et al. 2014). As a result, the amount of manure to be managed is increasing every year. The organic carbon content of Mediterranean soils is significantly low. This amount of manure could represent an opportunity for improving soil quality and for accomplishing the objectives of the '4 per 1000' initiative. The nitrous oxide emission factors (EF) are in general much lower than in temperate systems. In a recent meta-analysis, Cayuela et al. (2017) have shown how the semiarid conditions, together with

lower water input and moderate application rates clearly reduce emissions factors. For example, the weighted averaged nitrous oxide EF for rainfed systems is 0.27 %, a value that contrasts with 1% considered in the IPCC Tier 1 methodology for National Emission Inventories. Only sprinkler irrigation showed an EF not statistically different from 1%, while furrow and drip systems averaged 0.5%. The transition to Tier 2 or 3 is therefore important for Mediterranean countries (Sanz-Cobena et al. 2017). Concerning nitrate leaching in the Mediterranean region, the nitrification process is faster, but nitrate leaching from rainfed systems is highly variable depending on the climatic conditions, with huge interannual variations. In irrigated systems, particularly those heavy fertilized with manures in areas of animal concentration, the leaching can be very high after the irrigation events. A good water management could reduce 58% of the nitrate leaching. During the last decades, the pollution of freshwater has increased in several Mediterranean basins such as the Ebro (Lassaletta et al. 2009). Once the nitrogen has been exported from the cropping systems to the freshwaters, the N that is retained in the basin without being exported to the coastal zone is very high: 95% of the N that is applied to the crops is retained while in temperate systems this proportion is much lower (75%). This is a consequence of the high-water regulation (irrigation channels and dams) associated with the water scarcity of these areas (Lassaletta et al. 2012; Romero et al. 2016). As a result, despite the risk of coastal eutrophication is lower, the threat for terrestrial pollution rises. In conclusion, nitrogen dynamics deeply depend on the water input and management and on the climatic variability. Rainfed and irrigated systems represent two contrasted worlds that do not match with the knowledge gained in the temperate systems. Mitigation, adaptation and water quality strategies have to be constructed in coordination and tailored at the regional scale.

**Acknowledgements:** L. Lassaletta was supported by the FP7 project LUC4C and by a ‘Ramon y Cajal’ research contract from the Spanish Ministry of Economy and Competitiveness (RYC-2016-20269).

## REFERENCES

- Aguilera, E., Lassaletta, L., Sanz-Cobena, A., Garnier, J., Vallejo, A., 2013. The potential of organic fertilizers and water management to reduce N<sub>2</sub>O emissions in Mediterranean climate cropping systems. A review. *Agriculture, Ecosystems & Environment* 164, 32-52.
- Cayuela, M.L., Aguilera, E., Sanz-Cobena, A., Adams, D.C., Abalos, D., Barton, L., Ryals, R., Silver, W.L., Alfaro, M.A., Pappa, V.A., Smith, P., Garnier, J., Billen, G., Bouwman, L., Bondeau, A., Lassaletta, L., 2017. Direct nitrous oxide emissions in Mediterranean climate cropping systems: Emission factors based on a meta-analysis of available measurement data. *Agriculture, Ecosystems & Environment* 238, 25-35.
- Lassaletta, L., García-Gómez, H., Gimeno, B.S., Rovira, J.V., 2009. Agriculture-induced increase in nitrate concentrations in stream waters of a large Mediterranean catchment over 25 years (1981-2005). *S* 407, 6034-6043.
- Lassaletta, L., Romero, E., Billen, G., Garnier, J., García-Gómez, H., Rovira, J.V., 2012. Spatialized N budgets in a large agricultural Mediterranean watershed: high loading and low transfer. *Biogeosciences* 9, 57-70.
- Lassaletta, L., Billen, G., Romero, E., Garnier, J., Aguilera, E., 2014. How changes in diet and trade patterns have shaped the N cycle at the national scale: Spain (1961–2009). *Reg. Environ. Change* 14, 785-797.
- Quemada, M., Gabriel, J.L., 2016. Approaches for increasing nitrogen and water use efficiency simultaneously. *Global Food Security* 9, 29-35.
- Romero, E., Garnier, J., Billen, G., Peters, F., Lassaletta, L., 2016. Water management practices exacerbate nitrogen retention in Mediterranean catchments. *Science of the Total Environment* 573, 420-432.
- Sanz-Cobena, A., Lassaletta, L., Garnier, J., Smith, P., 2017. Mitigation and quantification of greenhouse gas emissions in Mediterranean cropping systems. *Agriculture, Ecosystems & Environment* 238, 1-4.
- Wriedt, G., Van der Velde, M., Aloe, A., Bouraoui, F., 2009. Estimating irrigation water requirements in Europe. *Journal of Hydrology* 373, 527-544.

## **POTENTIALS FOR SIMULTANEOUS IMPROVEMENT OF PHOSPHORUS AND NITROGEN MANAGEMENT IN AUSTRIA**

TANZER, J.<sup>1</sup>, RECHBERGER, H.<sup>2</sup>, ZESSNER, M.<sup>2</sup>, ZOBOLI, O.<sup>2</sup>

<sup>1</sup> Center for Water Resource Systems, TU Wien, Karlsplatz 13/222, A-1040, Vienna, Austria; <sup>2</sup> Institute for Water Quality and Resource Management, TU Wien, Karlsplatz 13/226, A-1040 Vienna, Austria

### **INTRODUCTION**

Both phosphorus (P) and nitrogen (N) are essential plant nutrients and, as fertilizers, play an essential role in ensuring global food security. However, they are currently mainly used in a linear way, with high imports or production of mineral fertilizer and high losses to water, air and landfills. This creates various problems: P is a non-renewable resource and reserves are concentrated in few and geopolitically unstable regions, giving rise to high price fluctuations. Moreover, P emissions to water bodies are a main cause for eutrophication. Contrary to phosphorus, nitrate fertilizer can be industrially produced in the Haber-Bosch-Process; however, this requires high energy input. Reactive N released into the environment contributes to problems like air and ground water pollution, acidification, eutrophication and climate change.

Recently, efforts to make management of P and N more efficient and sustainable have grown; however, most studies to date are restricted to one substance or a single sector or process. Given the close connection of their cycles, interactions between measures targeting P and N management are to be expected though. This study simultaneously looks at P and N management and options for improvement in the national context of Austria, in order to identify co-benefits and negative side-effects between the two substances.

### **MATERIAL AND METHODS**

The analysis is based on a coupled material flow analysis (MFA) for P and N, following the methodology described by Brunner and Rechberger (2017) and building on the Austrian MFA for P (Zoboli et al., 2015). The freeware STAN (Cencic and Rechberger, 2012) was used to calculate mass balances and to perform error propagation and data reconciliation. Uncertainty of model input data was characterized according to a method developed by Laner et al. (2014), in which qualitative data classification and exponential-type uncertainty characterization functions are combined.

The coupling of the P and N balance was achieved by introducing a goods-layer into the system, which represents the total mass of a stock or flow. Coupling takes place during data reconciliation, when masses and concentrations of flows are adjusted so that the mass balance for all processes is kept on both the P and the N layer.

To evaluate the effects of different management options, scenarios looking at measures to reduce P and/or N-demand, increase recycling or reduce their losses to air or water were compared to a reference state, representing the actual situation in 2015. Indicators used for assessment include the demand of mineral P- and N-fertilizer, emissions to air (N only) and water bodies, P accumulation in agricultural soil as well as losses in the waste sector.

### **RESULTS AND DISCUSSION**

The analysis confirmed the close connection between the P- and N-system. Overall measures to improve P-management have positive effects on the N-system and vice versa, which is why highest efficiency gains can be achieved by a combination of all the 16 measures studied (see Table 1). Large potentials lie in the reduction of mineral fertilizer demand, whereas emissions to water bodies can only be reduced to a lesser extent. This is partly an effect of successful emission reduction measures

in the past and shows that society to date has made more progress in environmental- than in resource protection.

Few measures directly target the reduction of N-emissions to the atmosphere. Efforts are being made to convert reactive nitrogen into N<sub>2</sub> prior to emission; however, distinction of different N species was out of the scope of this study. N<sub>2</sub> can be regarded as unproblematic in terms of air pollution and climate change. Nevertheless, measures to keep N within the system similar to the ones currently under development for P could be beneficial in terms of reducing the energy demand for N-fertilizer production.

*Table 1. Improvement potential compared to the status quo. An improvement potential of 1 refers to a state, where mineral fertilizer is completely replaced by recycled products and no losses to the waste sector, soil, water and atmosphere occur. Numbers in brackets indicate data uncertainty. Only measures with a significant total improvement potential are shown.*

Improvement potential	Min. P-fertilizer demand	P-losses in waste sector	P water emissions	P soil accumulation	Min. N-fertilizer demand	N-losses in waste sector	N water emissions	N air emissions	Total
Combined measures	0.121 (0.008)	0.095 (0.007)	0.062 (0.010)	0.090 (0.015)	0.10 (0.03)	0.079 (0.018)	0.08 (0.04)	0.043 (0.010)	0.67 (0.05)
Improved fertilizer application	0.086 (0.015)	0.002 (0.014)	0.031 (0.014)	0.079 (0.013)	0.07 (0.04)	-0.000005 (0.036318)	0.06 (0.05)	0.018 (0.012)	0.34 (0.07)
Improved meat and bone meal recycling	0.021 (0.021)	0.028 (0.011)	0.00028 (0.02149)	-0.000005 (0.025431)	0.01 (0.04)	0.060 (0.018)	0.01 (0.07)	0.002 (0.015)	0.13 (0.10)
Improved sewage sludge recycling	0.043 (0.020)	0.054 (0.009)	0.001 (0.021)	0.003 (0.025)	-0.0001 (0.0433)	0.01 (0.04)	-0.001 (0.071)	-0.0001 (0.0139)	0.11 (0.10)

## CONCLUSION

By coupling flows of P and N in a combined MFA, the interrelations in management of these two substances could be revealed and co-benefits of measures identified that might have been overlooked in a single substance analysis. This opens the door to including other substances that might be affected by P and N management into the system and to developing frameworks for the analysis of coupled resource systems in general.

**Acknowledgements:** This research was funded by the Austrian Science Fund (FWF) as part of the Vienna Doctoral Programme on Water Resource Systems (DK-plus W1219-N22).

## REFERENCES

- Brunner P., Rechberger H., 2017. Handbook of material flow analysis: for environmental, resource and waste engineers. Second edition. Taylor & Francis, CRC Press, Boca Raton, London.
- Cencic O., Rechberger H., 2012. STAN 2.5.1302. Institute for Water Quality, Resources and Waste Management, TU Wien.
- Laner D., Feketitsch J., Rechberger H., Fellner J., 2015. A novel approach to characterize data uncertainty in MFA and its application to plastic flows in Austria. *Journal of industrial ecology*, 20 (5), 1050-1063.
- Zoboli O., Laner D., Zessner M., Rechberger H., 2015. Added Values of Time Series in Material Flow Analysis – The Austrian Phosphorus Budget from 1990 to 2011. *Journal of industrial ecology*, 20 (6), 1334-1348.

**GREENHOUSE GASES EMISSIONS FROM AGRICULTURE IN THE NORTH OF FRANCE (1852-2014):  
CONSEQUENCE OF SPECIALISATION AND INTENSIFICATION**

GARNIER J.<sup>1</sup>, LE NOË J.<sup>1</sup>, MARESCAUX A.<sup>1</sup>, SANZ-COBENA A.<sup>2</sup>, THIEU V.<sup>1</sup>, BILLEN G.<sup>1</sup>

<sup>1</sup> Sorbonne Université, UPMC, CNRS, EPHE, UMR 7619 METIS, 4 place Jussieu, Paris, France; <sup>2</sup> UPM, Universidad Politécnica de Madrid, ETSI Agrónomos, Av. Complutense s/n, 28040, Madrid, Spain

**INTRODUCTION**

The Seine basin is a region particularly dedicated to intensive cereal farming, while livestock is now only present in its periphery. This specialization of the Seine basin in cereals increased in the second half of the 20th century, along with an extreme specialization of Brittany into intensive livestock farming. Before that period, livestock kept a central place in cropping systems and local recycling of nutrients limited the need for exogenous fertilizers. We aimed at analysing the spatial-temporal trajectory of greenhouse gas emission from agriculture to disentangle the respective role of specialization and intensification in greenhouse gas emissions.

**MATERIAL AND METHODS**

N<sub>2</sub>O and CH<sub>4</sub> budgets have been established in the Seine basin for the current period with emission coefficients determined from field (Garnier et al., 2009, 2013; Benoit et al. 2015; unpublished) and literature data. N<sub>2</sub>O emissions from cropland were linked to mineral fertilizer use and rainfall (Figure 1). CH<sub>4</sub> emissions were calculated according to the composition of livestock and its excretion (Garnier et al., 2013), taking also into account for the long term, the evolution of excretion factors for each class of animal (Le Noë et al., submitted and ref. therein). Historical trends in agricultural greenhouse gas emissions (CH<sub>4</sub> and N<sub>2</sub>O) were then reconstructed from the late 19<sup>th</sup> century to the present day based on the GRAFS analysis (Generalized Representation of Agro-Food System, after Billen et al., 2013).

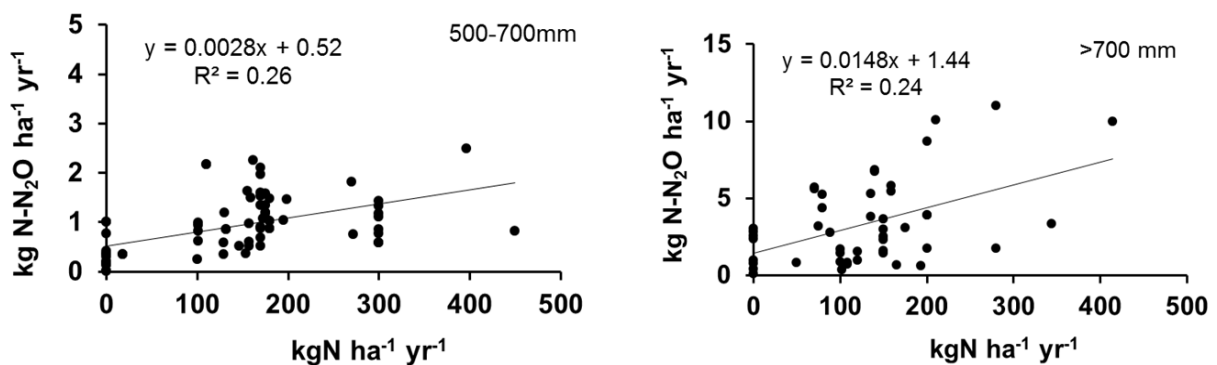

Figure 1. a. Relationship between N<sub>2</sub>O emissions and cropland fertilisation for e.g. two classes of rainfall

**RESULTS AND DISCUSSION**

The trajectories of N<sub>2</sub>O emissions were parallel all over the studied period, 30-40 % higher for the Great West compared to the Seine Basin. Rather stable from the end of the 19<sup>th</sup> century to the middle of the 20<sup>th</sup> century, N<sub>2</sub>O emission doubled in the 1980s, and decreased from the 1980's, when fertilisation was decreased too. CH<sub>4</sub> emissions were rather stable in the Seine basin although the livestock was concentrated at the periphery of the Basin to allow cropping intensification in fertile loam soils in the center of the basin. In the Great West, CH<sub>4</sub> was multiplied by about four during the same time with intensified livestock breeding (Figure 2). Manure management which represented half of the enteric fermentation until the 1950s increased to 75% in the recent year reflecting a change in grazing practices.

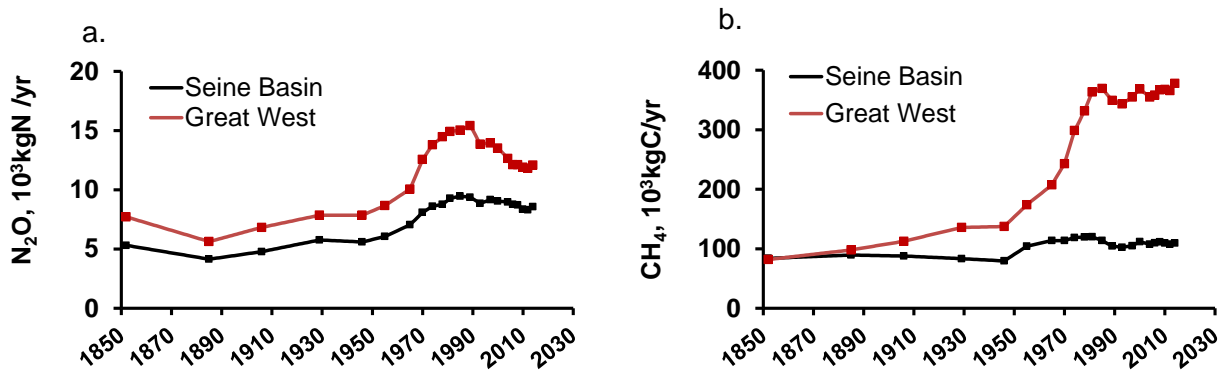

Figure 2. Long term trajectories of a.  $N_2O$  emissions and b.  $CH_4$  emissions for the two contrasted regions, Seine Basin and Great West

The GRAFS approach also allowed running prospective scenarios showing that the pursuit of specialization would level off  $N_2O$  emissions in both regions, but would increase  $CH_4$  in the Great West and decreased it in the Seine Basin. On the contrary, in a more virtuous scenario with a reconnection of crop and livestock farming and general transition to organic farming would increase  $CH_4$  emissions in the Seine Basin by a factor of two, while reducing four times those in the Great West.

## CONCLUSION

The GRAFS analysis of historical farming systems makes it possible, in addition to exploring agricultural performance and leakage to hydrosystems, to estimate emissions to the atmosphere.

The transition to industrial agriculture and its territorial specialization were accompanied by a significant increase in GHG emissions, that deep changes in agriculture could reverse.

## REFERENCES

- Benoit M., Garnier J., Billen G., Tournebize J., Gréhan E., Mary B. (2015). Nitrous oxide emissions and nitrate leaching in an organic and a conventional cropping system (Seine basin, France). *Agric. Ecosyst. Environ.* 213: 131–141. doi:10.1016/j.agee.2015.07.030
- Billen G., Garnier, J., Lassaletta L. (2013). Modelling the nitrogen cascade from watershed soils to the sea: from regional to global scales. *Phil. Trans. R. Soc. B* 2013 **368**, 20130123. DOI: 10.1098/rstb.2013.0123
- Garnier J., Billen G., Vilain G., Martinez A., Mounier E., Silvestre M., Toche F. (2009). Nitrous oxide ( $N_2O$ ) in the Seine river and basin: observations and budgets. *Agric. Ecosyst. Environ.* 133: 223–233. doi:10.1016/j.agee.2009.04.024.
- Garnier J., Vilain G., Jehanno S., Silvestre M., Billen G., Poirier D., Martinez A., Decuq C., Cellier P., Abril G. (2013). Methane emissions from land use, livestock farming, and the river network of the Seine basin (France), *Biogeochemistry*, 116:199–214. DOI 10.1007/s10533-013-9845-1
- Le Noë J., Billen G., Esculier F., Garnier J. (submitted). Long term socio-ecological trajectories of agro-food systems revealed by N and P flows: the case of French regions from 1852 to 2014. *Agric. Ecosyst Environ.*

**DRIVING FORCES OF FOOD SYSTEM NITROGEN FLOWS IN CHINA, 1990 TO 2012**GAO BING<sup>1,2</sup>, HUANG, WEI<sup>1,2</sup>, CUI SHENGHUI<sup>1,2\*</sup><sup>1</sup> Key Lab of Urban Environment and Health, Institute of Urban Environment, Chinese Academy of Sciences, Xiamen 361021, PR China; <sup>2</sup> Xiamen Key Lab of Urban Metabolism, Xiamen 361021, PR China**INTRODUCTION**

As the largest Nr producer and consumer, the largest population in the world and undergoing the largest urbanization in the world in the last few decades (Bai et al., 2014), China is an interesting case that demonstrates how population growth, dietary changes, people's movements in urbanization and N management practices can affect long-term trends in N use and loss from food production and consumption system by an emerging economy. This study aimed (i) to analyze the historical trends in per capita food N consumption and the differences in per capita food N consumption between urban and rural areas from 1990 to 2012; (ii) to estimate the changes in animal-food N (AN) and plant-food N (PN) consumption, driven by population growth, dietary changes associate with income growth and rural-urban migration; (iii) to quantify the contributions of the above key drivers to inputs of N through the food system.

**MATERIAL AND METHODS**

The material flow analysis approach was adapted for quantifying the flows of N in the Chinese food system, which was divided into five categories: crop production, animal-food production, food processing, household consumption (including both urban and rural households), and waste disposal. Mass balance calculations as a basic principle (inputs = outputs + accumulations) were adopted for the calculations of N input, output and accumulations in different sectors of the entire food system, if no data were available for calculating them directly (Ma et al., 2012; Cui et al., 2016). The impacts of population growth, dietary changes associated with income growth, and rural-urban migration on the national AN and PN consumption was quantified by setting up different scenarios (Table 1). The impacts of these factors on N input to the Chinese food system was calculated by the variation of AN and PN, driven by the three factors multiplied by the N costs of AN and PN consumption.

*Table 1 Description of the scenarios and the calculations of driving force effects*

Code	Scenario description	Driving force effect calculation	
S1	Urban and rural populations maintained at level of 1990, dietary unchanged as 1990 and no people moved to cities	$S1_{2012} - S1_{1990}$	N management practices effect (this effect only for N input)
S2	Urban and rural dietary changes based on S1	S2-S1	Dietary changes effect
S3	Population growth based on S2	S3-S2	Population growth effect
RS	Real situation, population growth, dietary changes and people moved to cities	RS-S3	People's movements in urbanization effect

**RESULTS AND DISCUSSION**

New N input to Chinese food system increased by 16.7 Tg from 1990 to 2012. China's population growth, dietary changes and rural-urban migration created a need for 7.6 Tg increased N to support these changes over the past 20 years. The remaining 54%, increase in N input was mainly due to the decrease in the NUE of the Chinese food system, from 16% to approximately 9%, between 1980 and 2009 (Ma et al., 2012). These results indicate that the increased N input to the Chinese food system is not merely due to over-fertilization by Chinese farmers (Chen et al., 2014), but has been driven by population growth, dietary changes and rural-urban migration.



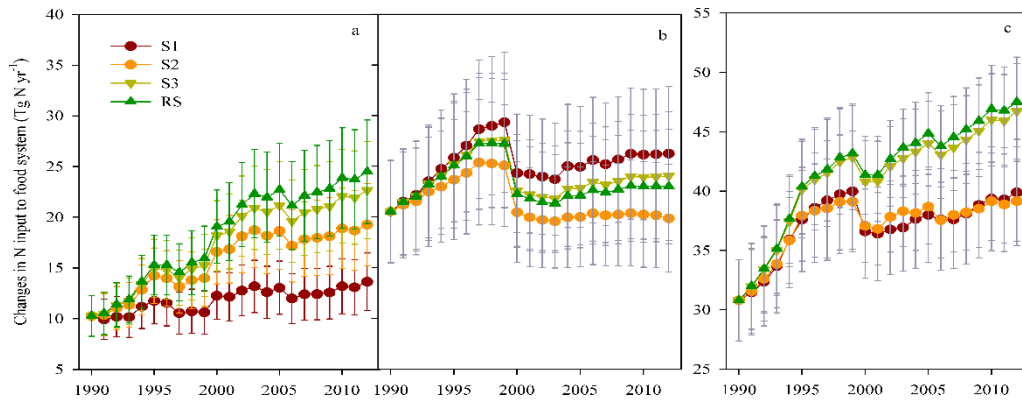

Figure 1 The changes in N input to Chinese food system, driven by population growth, dietary changes and rural-urban migration relative to 1990, during 1990–2012

## CONCLUSION

Our analysis indicates that China is facing higher risks of environmental N pollution with urbanization, because of the higher N input to the food system caused by the additional demand for AN precipitated by population growth and rural-urban migration (and this trend will continue, and even increase, under China's urbanization). The strategies for reducing the risks of N losses to the environment involve guiding the urban and rural dietary changes to the recommended energy standards, and to mitigate the increase in demand for AN, etc.

**Acknowledgements:** This manuscript is sponsored by the National Basic Research Program of China (2014CB953801), the Young Talents Projects of the Institute of Urban Environment, the Chinese Academy of Sciences (IUEMS201402).

## REFERENCES

- Bai, X.M., Shi, P.J., Liu, Y.S., 2014. Society: realizing China's urban dream. *Nature* 509 (7499), 158–160.
- Cui, S.H., Shi, Y.L., Malik, A., Lenzen, M., Gao, B., Huang, W., 2016. A hybrid method for quantifying China's nitrogen footprint during urbanization from 1990 to 2009. *Environ. Int.* 97, 137–145.
- Ma, L., Velthof, G.L., Qin, W., Zhang, W.F., Liu, Z., Zhang, Y., Wei, J., Lesschen, J.P., Ma, W.Q., Oenema, O., Zhang, F.S., 2012. Nitrogen and phosphorus use efficiencies and losses in the food chain in China at regional scales in 1980 and 2005. *Sci. Total Environ.* 434, 51–61.

## ASSESSMENT OF SPATIALLY EXPLICIT NEEDED INCREASE IN NITROGEN USE EFFICIENCY IN EUROPEAN AGRICULTURAL SOILS IN VIEW OF AIR AND WATER QUALITY

DE VRIES, W.<sup>1,2</sup>, KROS, J.<sup>2</sup>, VOOGD, J.C.<sup>2</sup>, LOUWAGIE, G<sup>3</sup>

<sup>1</sup> Environmental Systems Analysis Group, Wageningen University and Research, Wageningen, Netherlands; <sup>2</sup> Wageningen Environmental Research, Wageningen, Netherlands; <sup>3</sup> European Environment Agency, Copenhagen, Denmark

### INTRODUCTION

The intensification of European agriculture, including large inputs of nitrogen (N) to soil by fertilizers and manure, has led to an increase in crop growth but also to adverse effects on the environment (Sutton et al., 2011). In several regions in Europe, high N inputs have led to: (i) eutrophication of surface waters due to increased N runoff, (ii) increased nitrate (NO<sub>3</sub>) levels in drinking water reservoirs due to elevated NO<sub>3</sub> leaching and (iii) loss of terrestrial biodiversity due to increased emission and deposition of ammonia (NH<sub>3</sub>). Inversely, in other regions there is still room for increasing N inputs without exceeding critical thresholds for N losses. When current N inputs exceed critical N inputs, environmental objectives can only be reached by lowering N input, which likely would cause a loss in crop production, unless the nitrogen use efficiency (NUE) is increased. When the NUE is increased, the same crop yield can be reached with less N fertilizer, due to an enhanced N uptake fraction, while the critical N input increases since a lower fraction of N is lost to the environment. In this study we calculated critical N inputs and their exceedances (current N inputs minus critical N inputs) for agricultural soils in the EU-27 in view of effects on terrestrial and aquatic ecosystems due to NH<sub>3</sub> emissions to air and N runoff to surface water. The increase in NUE that is required to attain current crop yields while reducing NH<sub>3</sub>-N emissions to air and N runoff to surface water to acceptable environmental levels, was also calculated.

### MATERIAL AND METHODS

The derivation of critical N inputs in view of adverse environmental impacts consisted of three consecutive steps, i.e. (i) identification of critical values for defined N indicators, (ii) back-calculation of critical N losses to surface water or air that correspond to these critical values and (iii) back-calculation of critical N inputs from critical N losses. Calculations were carried out for approximately 40.000 unique combinations of soil type, slope class and altitude class, within a given socio-economic NUTS3 region. The results thus obtained were aggregated at NUTS3 level, country level and EU-27 level. The acceptable NH<sub>3</sub>-N emissions were set equal to mean critical N load in view of terrestrial ecosystem functioning. The acceptable N runoff to surface water was based on a critical concentration of dissolved total N in surface water of 2.5 mg N l<sup>-1</sup>, in view of eutrophication of aquatic ecosystems (Liu et al., 2011). The INTEGRATOR model was used to calculate current and critical N inputs at EU-27 level (De Vries et al., 2011) using each criterion separately and the minimum of both criteria. The calculated, spatially-explicit critical N inputs in view of losses to air and water were compared with current N inputs (reference year 2010). For areas where current N inputs exceeded critical N inputs, we calculated the needed increase in NUE, defined as crop N removal divided by the total N input by fertilizer, manure, deposition and fixation, to attain environmental objectives at current crop yields.

### RESULTS AND DISCUSSION

The calculations at EU-27 level showed that current (2010) N inputs exceeded critical N inputs by approximately 20%, using either critical N concentrations in surface water or critical NH<sub>3</sub>-N emission-deposition rates as criterion (Table 1). Relatively high exceedances were found in regions with high total N inputs, such as Ireland, the Netherlands, Belgium and Luxembourg, Bretagne in France and the Po valley in Italy. In several regions, the current N input was, however, lower than the critical N input, e.g. due to high precipitation allowing high N runoff rates or to low N inputs.

Table 1. Average current (2010) and critical annual N budgets of agricultural land in EU-27 calculated by INTEGRATOR based on a critical N concentration in surface water of 2.5 mg N l<sup>-1</sup>, a critical NH<sub>3</sub>-N emission and the minimum of both criteria.

Source	N budget EU-27 (kg N ha <sup>-1</sup> yr <sup>-1</sup> )			
	Current	Critical N runoff 2.5 mg N l <sup>-1</sup>	Critical NH <sub>3</sub> -N emission	Minimum critical runoff and emission
<i>Input to land</i>				
Fertilizer +fixation	79	73	67	62
Excretion+ biosolids	59	45	35	33
Total input	138	118	102	95
<i>Output from land</i>				
Crop uptake	101	93	80	75
Total surplus	37	25	22	20
Denitrification	28	18	15	14
Leaching + runoff	18	7	7	66
Soil accumulation	-9	0	0	0
Total output	138	118	102	95

The calculated NUE values that are needed to attain the current crop yield while not exceeding critical environmental thresholds nearly always ranged between 50 and 90% (Figure 1). There is thus a clear need for a spatial reallocation of the N inputs to N-deficient regions and an increase in NUE in highly productive regions to avoid environmental impacts while maintaining crop production.

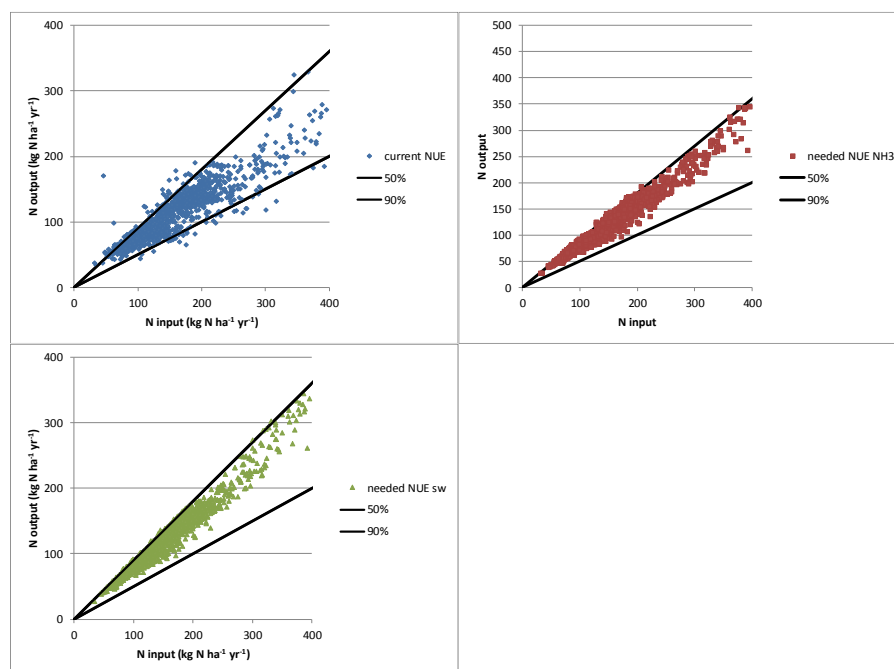

Figure 1. The ratio between N output and input (NUE) when using the current input and output data (left) and NUE increase required to attain the current crop yield while NH<sub>3</sub> losses to air (middle) or N losses to surface water (right) are acceptable.

## CONCLUSION

Current (2010) N inputs were approximately 20% higher than critical N inputs related to critical N concentrations in surface water or critical NH<sub>3</sub>-N emission rates. The NUE generally needs to increase

to 70-90% to attain current crop yields at acceptable NH<sub>3</sub>-N emissions to air and acceptable N runoff rates to surface water.

#### REFERENCES

- De Vries W., Leip A., Reinds G.J., Kros J., Lesschen J.P., Bouwman A.F., 2011. Comparison of land nitrogen budgets for European agriculture by various modelling approaches. *Environ. Pollution*, 159-11, 3254-3268.
- Liu C., Kroeze C., Hoekstra A.Y., Gerbens-Leenes W., 2011. Past and future trends in grey water footprints of anthropogenic nitrogen and phosphorus inputs to major world rivers. *Ecol. Indic.*, 18, 42-49.
- Sutton M.A., Howard C.M., Erisman J.W., Bealey W.J., Billen G., Bleeker A., Bouwman A.F., Grennfelt P., van Grinsven H., Grizzetti B., 2011. The challenge to integrate nitrogen science and policies: the European Nitrogen Assessment approach. In: Sutton M.A., Howard C.M., Erisman J.W., Billen G., Bleeker A., Grennfelt P., van Grinsven H., Grizzetti B. (Eds.), *The European Nitrogen Assessment*. Cambridge University Press, Cambridge, pp. 82-96.

## HISTORIC TRENDS IN N AND S DEPOSITION IN THE UK: 1800 TO PRESENT

DRAGOSITS U.<sup>1</sup>, TOMLINSON S.J.<sup>1</sup>, CARNELL E.J.<sup>1</sup>, DORE A.J.<sup>1</sup>, MISSELBROOK T.H.<sup>2</sup>, SIMPSON D.<sup>3,4</sup>,  
LANGFORD B.<sup>1</sup>, MULLINGER N.<sup>1</sup>, NEMITZ E.G.<sup>1</sup>, SUTTON M.A.<sup>1</sup>

<sup>1</sup> NERC Centre for Ecology & Hydrology (CEH) Edinburgh, UK; <sup>2</sup> Rothamsted Research North Wyke, UK; <sup>3</sup> EMEP/MSC-W Norwegian Meteorological Institute, Norway, <sup>4</sup> Chalmers University of Technology Gothenburg, Sweden

### INTRODUCTION

The legacy of nitrogen (N) and sulfur (S) accumulation and its spatial distribution is an important part of assessing current threats to ecosystems and the ecological response to accumulated N-pools over time. High atmospheric pollutant concentrations also significantly affect human health. As part of a UK project (NERC Macronutrients Long-Term Large-Scale (LTLS); e.g. Tipping et al., 2017), historic N and S deposition and its spatial distribution in the UK from 1800 to present was estimated. The main sources of N and S deposition are NO<sub>x</sub> and SO<sub>2</sub> emissions from combustion (industry, transport etc.), and ammonia (NH<sub>3</sub>, largely from agriculture). The magnitude of atmospheric SO<sub>2</sub> concentrations affects the chemical transformations and therefore the lifetime and transport distance of N-containing gases and particles before deposition, especially for NH<sub>3</sub> which is highly reactive. Given the importance of N input to terrestrial and freshwater systems regarding macronutrient pools and fluxes, quantifying these is a key input to wider historic modelling of macronutrients, to answer fundamental questions that can be simply summarised as ‘how did we get to where we are today?’ and consider the implications on future trends and mitigation strategies.

### MATERIAL AND METHODS

This study reconstructed atmospheric emission, concentration deposition timelines back to 1800 over six time slices (2010, 1990, 1970, 1950, 1900 and 1800). Key tasks involved research into historical trends of emissions of nitrogen and sulfur, their sources, emission source strengths and respective spatial distributions, and utilised auxiliary data including historic population, agricultural statistics and practice as well as land cover data. A key consideration was to develop a consistent multi-year spatial dataset that can be analysed, interpreted and compared across the 200 year time period. The Fine Resolution Atmospheric Multi-pollutant Exchange (FRAME) model (e.g. Matejko et al., 2009) was used to calculate UK concentration and deposition estimates of N and S compounds at a 5km grid resolution.

### RESULTS AND DISCUSSION

Results show that spatial patterns of N and S deposition have changed considerably over the 200+ year period, and how the local/regional deposition history (as well as the current and predicted future patterns of atmospheric deposition) vary widely across the UK (Figure 1). Spatial patterns also vary due to the non-linearity of changes in atmospheric chemistry, with decreasing presence of S compounds in the atmosphere prolonging the atmospheric lifetime of NH<sub>3</sub>. There is also considerable spatial and temporal variability in the distribution of wet and dry components of deposition, which in turn are dependent on precipitation, wind and orography.

Historically, both SO<sub>2</sub> and NO<sub>x</sub> emissions and deposition increased rapidly from the Industrial Revolution (~1760–1830) until mitigation measures were implemented through effective legislation from the 1980s, both at the international level (Sulfur and NO<sub>x</sub> Protocols of the UN ECE) and through national efforts regarding combustion and transport sources. By contrast, NH<sub>3</sub> emissions have only decreased very slowly over the last two decades, with only a small proportion of agricultural emissions regulated under the Industrial Emissions Directive (large pig and poultry farms). These data enable a wealth of more detailed assessments of cumulative atmospheric N and S inputs (through deposition as well as atmospheric pollutant concentrations) and their impacts, on habitats and species as well as on human health.

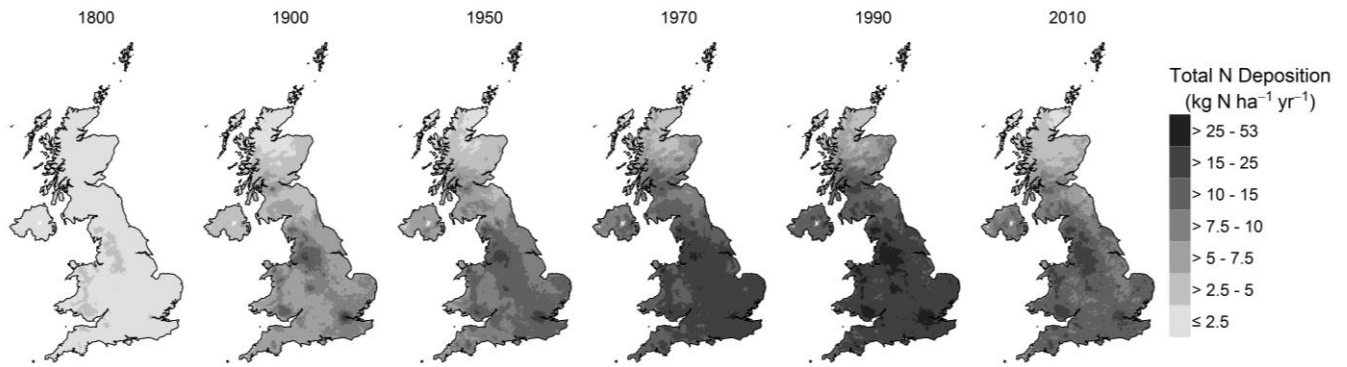

Figure 1. Total N deposition estimated for the UK for example time slices (1800, 1900, 1950, 1970, 1990, 2010) and predicted deposition for 2030 (considering policies currently in place, i.e. business-as-usual). Values represent grid average estimates rather than habitat specific estimates, taking account of land cover present in each grid square.

## CONCLUSION

Historic spatial trends of N and S deposition were shown to have changed substantially across the UK over the last 200+ years, both in terms of magnitude and spatial patterns. Considerable reductions in S emissions and deposition in particular, but also for NO<sub>x</sub> can be clearly attributed to international and national legislation. Reduced N deposition (from NH<sub>3</sub> emissions) is now the largest source of N deposition in the UK, with only relatively small decreases in the recent past. Historical time series datasets such as the study presented here may allow further investigation of legacy effects as well as the interpretation of current distributions of habitats and species sensitive to N inputs and acidification, and population-level human mortality rates or shortened life expectancy.

**Acknowledgements:** This research was funded by the UK Natural Environment Research Council Macronutrient Cycles Programme (LTLS project, grants NE/J011533/1 and NE/J011703/1) and by the Rural & Environment Science & Analytical Services Division of the Scottish Government. Online datasets used include Vision of Britain (<http://www.visionofbritain.org.uk/>) and Edina AgCensus data (<http://edina.ac.uk/agcensus/>) at Edinburgh University Data Library, which are gratefully acknowledged.

## REFERENCES

- Matejko M., Dore A.J., Hall J., Dore C.J., Blas M., Kryza M., Smith R.I. and Fowler D., 2009. The influence of long term trends in pollutant emissions on deposition of sulphur and nitrogen and exceedance of critical loads in the United Kingdom. *Environmental Science & Policy* 12, 882-896. <https://doi.org/10.1016/j.envsci.2009.08.005>
- Tipping E., Davies J., Henrys P., Kirk G., Lilly A., Dragosits U., Carnell E., Dore A., Sutton M. and Tomlinson S., 2017. Increases in soil carbon due to ecosystem fertilization by atmospheric nitrogen deposition. *Nature Scientific Reports* 7:1890. <https://doi.org/10.1038/s41598-017-02002-w>

## THE NITROGEN OPERATING SPACE OF AGRICULTURE: CONNECTING NITROGEN SELF-SUFFICIENCY TO MAXIMUM NET PRODUCTION

HARCHAOUI, S.<sup>1</sup>, CHATZIMPIROS, P.<sup>1</sup>

<sup>1</sup> Laboratoire Interdisciplinaire des Energies de Demain (LIED), Université Paris Diderot, France.

### INTRODUCTION

Industrial nitrogen (N) fertilizers ( $N_{ind}$ ) have played a key role in global agricultural productivity and are estimated to have underpinned a net doubling in global population over the 20<sup>th</sup> century (Smil, 2002; Erisman et al. 2008). N inputs to agriculture rely on two additional natural mechanisms, namely atmospheric N deposition ( $N_{atm}$ ) and biological nitrogen fixation (BNF), but unlike  $N_{ind}$ , the supply capacity of those mechanisms is restricted by land availability. BNF is not performed by cash crop, but only by leguminous crops, mostly fodder crops, which compete for land with cash crops. In preindustrial systems, the necessity to set aside land for BNF was a major limiting factor of total production. The use of  $N_{ind}$  lifts this constraint, but increases the dependency of food production on fossil fuels and induces emission of greenhouse gases. In addition, the resulting abundance of  $N_{ind}$  may trigger poor N management practices and high N losses with severe consequences for ecosystems and human health (Foley et al., 2011). The abundance of  $N_{ind}$  also drives the decoupling between vegetal and animal farming systems, which hampers the recovery of manure N into crop production. The use of  $N_{ind}$  has deeply transformed the N operating space of agriculture by disconnecting total production from N self-sufficiency. The implications of a sharp reduction of  $N_{ind}$  (either due to climate policy, fossil fuel use restrictions, societal demand for organic agriculture) on the feeding capacity of world agriculture have received little scrutiny (Erisman et al. 2008). This paper provides a modeling approach of the nitrogen operating space of agriculture and assesses scenarios of agricultural productivity and N self-sufficiency as a function of key structural agricultural variables.

### MATERIAL AND METHODS

The study system is the utilized agricultural area considering N fixing land (sum of all N fixing grasslands, fodder and food crops) and non-fixing land (major arable crops). Total N input ( $N_{tot}$ ) to the system is the sum of BNF,  $N_{ind}$  and  $N_{atm}$ , which is set constant to  $5 \text{ kgN ha}^{-1} \text{ yr}^{-1}$ . The N self-sufficiency is defined as the ratio of BNF and  $N_{atm}$  to  $N_{tot}$ . BNF is transferred from fixing to non-fixing land through manure N recovery and cropland rotations. Manure N is calculated as a function of the nitrogen conversion efficiency (NCE) of feed to food by livestock. For ruminants, feed is provided by BNF land and equals the above-ground N yield ( $BNF_{yield}$ ). Total BNF rate ( $r_{BNF}$ ) is the sum of  $BNF_{yield}$  plus the non-extracted N calculated from the N harvest index of fixing crops and assumed to be transferred to non-fixing land through crop rotations. The N net production is defined as the sum of the vegetal and livestock production of agriculture, minus the feed calculated from livestock NCE. The share of grain used as feed ( $\alpha$ ) is a key parameter. Table 1 summarizes the structural variables of the model and the values used in the simulations inspired by results from historical analysis for France (Harchaoui and Chatzimpiros, accepted) and by current world estimates. The simulations consider constant fertilization rate on arable land for a crop yield of  $110 \text{ kgN ha}^{-1}$  obtained with nitrogen use efficiency (NUE) of 70 % which can both be considered as optimal in current agriculture.

### RESULTS AND DISCUSSION

Figure 1 quantifies the net N production of agriculture as a function of the N self-sufficiency for the three scenarios of table 1. The share of grain to livestock is set at 35 % in all scenarios, which is the current value for both France and the world (Harchaoui and Chatzimpiros, accepted; Foley et al., 2011). In contrast, the production from ruminants increases with BNF through a structural correlation which is possibly counterintuitive. It highlights the pivotal role of ruminants in N self-sufficient systems (organic agriculture) and challenges the visions that combine agricultural N self-sufficiency and

vegetarian diets. The results highlight the relevance of high manure recovery rates in particular in high N self-sufficiency regimes. Without N industrial fertilizers, the model predicts a drop by half of the global N net production which is in line with estimates from Smil (2002) updated by Erisman et al (2008). There is a variety of options to feed the 9.7 billion people projected by FAO in 2050. Under the S1 scenario, the N self-sufficiency would drop below 0.25. If the production was to be sustained solely by BNF, major changes including a tripling of  $r_{BNF}$  (from 12 to 35 kgN ha<sup>-1</sup>) and an increase of NUE to 70% would be necessary (S2 scenario). The very high scenario (S3) considers an increase by an order of magnitude of current world average  $r_{BNF}$  and may only be conceivable for a handful of western countries. The trajectory of France in fig1 is driven by the concomitant increase of N yields and NUE.

Table1. Structural agricultural variables and values used in the simulations inspired by results from historical analysis for France (Harchaoui and Chatzimpiros, accepted) and from current world estimates. Sources: (1) Lassaletta et al. (2014) (2) Smil (2002), (3) FAOSTAT (2017),(4) Foley et al (2011), (5) Calculated.

Variables	France			World	Scenarios		
	1980-1991	1992-2002	2003-2013	2013	Current world $r_{BNF}$ (S1)	High $r_{BNF}$ (S2)	Very high $r_{BNF}$ (S3)
$r_{BNF}$ fixing kgN ha <sup>-1</sup>	35	38	35	12 <sup>(2)</sup>	12	35	35 -> 100
Fixing to total area %	49	45	44	67 <sup>(5)</sup>	variable	variable	variable
N industrial kgN ha <sup>-1</sup>	78	79	73	22 <sup>(3)</sup>	variable	variable	variable
Yield non-fixing kgN ha <sup>-1</sup>	97	110	119	60 <sup>(5)</sup>	60	110	110
Grain to livestock $\alpha$ %	39	38	37	35 <sup>(4)</sup>	35	35	35
Livestock NCE %	21	21	20	-	22	22	22
NUE non-fixing <sup>(1)</sup> %	43	60	71	-	50 <sup>(2)</sup>	70	70
Net production kgN ha <sup>-1</sup>	38	46	51	13 <sup>(3)</sup>			
% Livestock in net N prod.	25	20	18	15			
N self-sufficiency %	25	19	20	34 <sup>(5)</sup>			

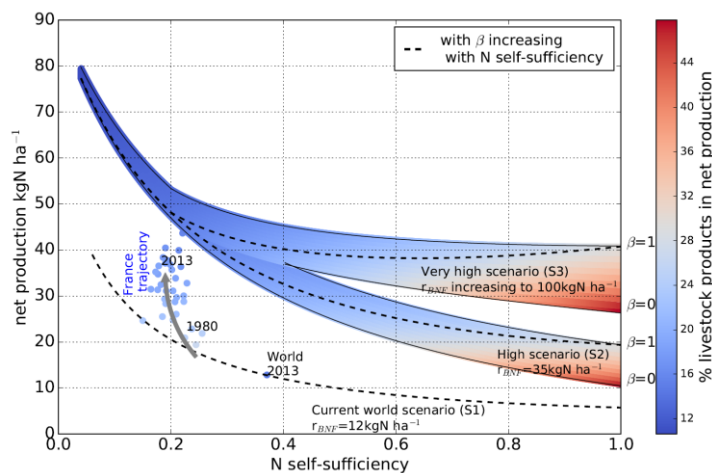

Figure 1. Relationship between maximum N net production per ha and N self-sufficiency for three scenarios. i) Current average world N fixing rate ( $r_{BNF} = 12 \text{ kgN ha}^{-1}$ ) ii) High  $r_{BNF} = 35 \text{ kg ha}^{-1}$  (western countries) iii) Increasing  $r_{BNF}$  (from 35 to 100 kgN ha<sup>-1</sup>) as a positive function of N self-sufficiency. In each scenario, the range of net N production is determined by the manure recovery rate  $\beta \in [0, 1]$ . The color code indicates the share of livestock in total net production. The trajectory for France (1980 to 2013) is indicated for comparison.

**CONCLUSION**

This paper models the N operating space of agriculture by connecting N self-sufficiency to net N production.

**REFERENCES**

Erisman J. et al. 2008. How a century of ammonia synthesis changed the world. Nature Geoscience 1(10): 636 - 639.



Session II: Regional studies – Oral presentations

- Foley, J. et al. 2011. Solutions for a cultivated planet. *Nature* 478(7369): 337–342
- Harchaoui S., Chatzimpiros P., accepted. Energy, nitrogen and farm surplus transitions in agriculture from historical data modeling. France, 1882-2013.
- Lassaletta, L. et al. 2014. 50 year trends in nitrogen use efficiency of world cropping systems: the relationship between yield and nitrogen input to cropland. *Environmental Research Letters* 9(10): 105011.
- Smil, V. 2002. Nitrogen and food production: proteins for human diets. *Ambio* 31(2): 126-131.

## **IMPACT OF NITROGEN MANAGEMENT PLANS ON WINTER SOFT WHEAT YIELD AND NITROGEN BALANCE AT EUROPEAN SCALE, SIMULATED WITH THE STICS CROP MODEL**

LECERF, R.<sup>1</sup>, VAN DER VELDE, M.<sup>1</sup>, DENTENER, F.<sup>1</sup>

<sup>1</sup> Food Security Unit - D5, JRC, European Commission, Italy

### **INTRODUCTION**

The nitrogen use efficiency of arable crops depends on climate and its variability, on soil types, the crops cultivated, and agro-management practices, a complex system that crop models can help to understand in order to improve current policies such as the EU's Nitrate directive (Asseng *et al.*, 2001). Improving nitrogen use efficiency (NUE) to reduce nitrate leaching and greenhouse gas emissions related to arable crop cultivation, while maintaining an economically sustainable yield, is the overall target of precision farming by optimizing fertilization practices, quantities applied, and dates of application considering weather conditions and soils.

A European view would benefit from determining the best set of practices at regional scale and their sensitivity to climate. Therefore, the STICS crop model is being implemented at European scale to simulate the yields, nitrogen and carbon balances of the main arable crops. This activity started by simulating winter soft wheat, using past climate and fertilization rates in order to establish a baseline scenario and highlight the limits and uncertainties of the crop model. The goal is to determine regionally the optimal fertilisation practices that would allow farmers to get the best reward from their production while optimising nitrogen use and limiting the losses.

The yields, nitrogen and carbon balance of several fertilization scenarios were simulated by the STICS crop model (Brisson *et al.*, 1998), using as input the nitrogen rates simulated by the CAPRI model (Henrichsmeyer *et al.*, 1997), the soil and meteorological data from the Crop Growth Modeling System from 1995 to 2010 (Baruth *et al.* 2007). The main fertilization scenarios used are mimicking basic fertilization management practices and precision farming, ranging from one nitrogen application to split nitrogen applications, applied according to crop phenological stages and crop needs, remaining nitrogen residues in the soil, and meteorological conditions.

### **MATERIAL AND METHODS**

#### **Crop model inputs, simulations and aggregation**

All input data required by the crop model are coming from the Food Security Unit of the Joint Research Center. The meteorological data and the soil hydraulic properties of the Crop Growth Modeling System (CGMS), available at a spatial resolution of 25km for the whole Europe are used. The sowing dates were also extracted from the CGMS database and a generic crop calibration was used, not accounting for the diversity of cultivars. The vernalisation requirements were adapted for each grid using a recent calibration produced for the WOFOST crop model simulations. Simulations, launched at a 25km resolution, are aggregated at NUTS-3 level using an arable land mask. From NUTS-3 level to NUTS-2 and higher hierarchical administrative levels, the cultivated area of winter soft wheat is used to weight the output results. The yields, mineral and organic nitrogen and carbon balances are thus available from the grid scale to the administrative scales relevant for policy making.

#### **Fertilization scenarios**

Three fertilization scenarios are simulated for all grids identified as arable land in Europe. The first scenario (sc1) consists of applying the entire amount of nitrogen at the end of winter, toward the tillering stage. A second scenario (sc2), designed to mimic precision agriculture, starts by establishing a simple provisional balance considering the yield targeted by farmers equals the amount of nitrogen reported by CAPRI divided by the nitrogen

needed to produce 1 quintal of grain, assumed to be equal to 3. Nitrogen is then applied depending on the plant needs and the nitrogen available in the soil as simulated by the crop model, splitting the nitrogen application in a maximum of 5. The last scenario (sc3) is identical to the previous one but the provisional balance targets a yield of 9.5t/ha, thus increasing the amount of nitrogen applied in southern and eastern Europe.

## RESULTS AND DISCUSSION

The main preliminary results indicate that splitting fertilization does not necessarily improve the NUE of the crop cultivated, but this does tend to diminish nitrate leaching, and increase protein levels. To be efficient, enough rain should fall after a nitrogen application. For instance, a crop fertilized at the tillering stage can have a higher NUE than a crop receiving 3 applications but without sufficient amounts of precipitation following it.

Establishing a provisional nitrogen balance and applying N according to available soil N, can help to maintain yields close to their current level but decrease the nitrogen rates substantially. On the other hand, when increasing the amount of nitrogen compared to the current level in intensive systems, even when considering precision agriculture, sampling soil, and establishing a provisional N balance, would only slightly increase yields but increase the quantity of nitrogen used substantially.

Table 1: Simulated yield and amount of nitrogen applied for the scenarios simulated at European scale

Scenario	Yields (t/ha)	N (kg/ha)
One Application (sc1)	5.21	140
Precision agriculture, targeting the current yield (sc2)	4.88	111
Variation sc1/sc2 (%)	-6.33	-20.71
Precision agriculture, targeting a yield of 9.5t/ha (sc3)	5.65	189
Variation sc1/sc3 (%)	+8.45	+35.00

## CONCLUSION

Adapting nitrogen applications to meteorological conditions, plant needs, and establishing a proper nitrogen balance, notably by measuring the nitrogen remaining in the soil, leads to an improvement of the Nitrogen Use Efficiency. Increasing the quantity of nitrogen in already intensive systems will tend to have a limited impact on yields, while considerably increasing environmental impacts. In regions where water stress is the main limiting factor, increasing nitrogen rates would have a limited impact on yields as long as no additional irrigation water is supplied. However, in many such regions, for instance in the Mediterranean, this may not be a feasible option in given the already limited availability of water.

## REFERENCES

- Asseng, S., Turner, N.C., Keating, B.A., 2001. Analysis of water- and nitrogen-use efficiency of wheat in a Mediterranean climate. *Plant and Soil* 233, 127–143.
- Baruth, B., Genovese, G., Leo, O., 2007. CGMS version 9.2 User manual and technical documentation. JRC40605. EUR 22936.
- Brisson, N., Mary, B., Ripoche, D., et al., 1998. STICS: a generic model for the simulation of crops and their water and nitrogen balances. I. Theory and parameterization applied to wheat and corn. *Agronomie* 18, 311–346.
- Henrichsmeyer, W., Britz, W., Heckeley, T., Meudt, M., Sander, R., 1997. Konzept eines regionalisierten, agrarsektoralen Politikinformationssystemes für den Agarsektor der EU: das CAPRI-Modell. In: *Agrarwirtschaft* Jg. 46, Heft 8/9, S. 322 - 324.

# 20<sup>th</sup> Nitrogen Workshop

## Coupling C-N-P-S cycles

June 25-27, 2018

Le Couvent des Jacobins, Rennes – France

### **Session II: Regional studies - Highlighted posters**

**MODELLING BIOMASS AND NUTRIENT FLOWS IN AGRO-FOOD SYSTEMS AT THE LOCAL SCALE. SCENARIO SIMULATION AND ASSESSMENT IN A FRENCH CASE-STUDY**

FERNANDEZ-MENA H.<sup>1,2,3</sup>, NESME T.<sup>2</sup>, MACDONALD GK<sup>4</sup>, PELLERIN S.<sup>1</sup>

<sup>1</sup>. INRA, UMR 1391 ISPA, F-33882 Villenave d'Ornon, France. <sup>2</sup>. Bordeaux Sciences Agro, Université de Bordeaux, UMR 1391 ISPA, F-33175 Gradignan, France. <sup>3</sup> Department of Agroecology and Environment, ISARA Lyon, U. Lyon, France. <sup>4</sup> Department of Geography, McGill University, Montreal, QC, H3A 2K6, Canada

**INTRODUCTION**

Solutions for towards farming sustainability require to improve nutrient and biomass recycling in agro-food systems to move out from linear flows of fertilizers, crop products, feedstuff, by-products and organic wastes (Lassaletta et al., 2014). Innovative tools quantifying material exchanges between farms and their upstream and downstream partners in agro-food systems at the local scale may be useful to explore circular nutrient flows (Davis et al., 2016). Designing and assessing alternative scenarios of material flows within local agro-food systems can help decision-makers to identify the feasibility and pathways to move towards nutrient reuse and recycling in circular economy (Smith et al., 2016). However, assessment of alternative scenarios is challenged by the complex nature of agro-food networks, which involve flows and relationships among different economic agents in the food production sector (e.g., farms, fertilizer and feed suppliers, slaughterhouses, food processors, and waste managers). Agent-based modelling appears to be a particularly important tool that enables the simulation of complex material flows among a wide range of individual agents and it can also be useful to assess the emergent system outcomes of different scenarios of agent behaviors (Fernandez-Mena et al., 2016).

In this study, we aimed to simulate alternative scenarios of material flows in a specific farming region. To do so, we create the FAN ("Flows in Agricultural Networks") agent-based model and applied it to a case study, the Ribéracois, in Dordogne, France. The FAN model is a powerful tool to simulate different scenarios, to assess a range of environmental outputs, and to simultaneously simulate multiple bio-sourced and biomass materials as a network of local potential exchanges. Our scenarios, deal with good management practices, organic waste recycling, bioenergy production, crop-livestock symbiosis and chemical fertilizers removal. Thanks to FAN simulations, our scenarios performances are evaluated through various environmental indicators.

**MATERIAL AND METHODS**

FAN model represent the following steps during a simulation cycle (equivalent to a year):

- (i) the production of fertilizing materials such as manure, digestates and sewage by farms, anaerobic digesters and wastewater treatment plants;
- (ii) the organic or chemical fertilizers are then applied to agricultural soils according to each farm's nutrient demand; (iii) farm's crop production is calculated as a function of fertilizing material inputs to soils through a simple linear yield-response model;
- (iv) animal feed requirements are estimated according to species-specific feed demand, and crop products are exchanged in order to meet these animal requirements. Once feed and forage requirements are satisfied, livestock production is calculated;
- (v) fruits, vegetables, and animal products are exchanged with local food industries, where they are processed, generating processed food and food wastes;
- (vi) anaerobic digesters inflow biomass wastes and perform the bioenergy production.

Note that global markets can create competition with local materials (e.g., imported chemical fertilizers can compete with local manures for fertilizing soils) or can compensate local production deficits (e.g., in feedstuff and forage to meet animal requirements).

The scenarios applied to FAN simulations for the riberacois are based on the efficiency substitution and redesign logic that can make each of them a progression on their environmental performance (Fig. 1).

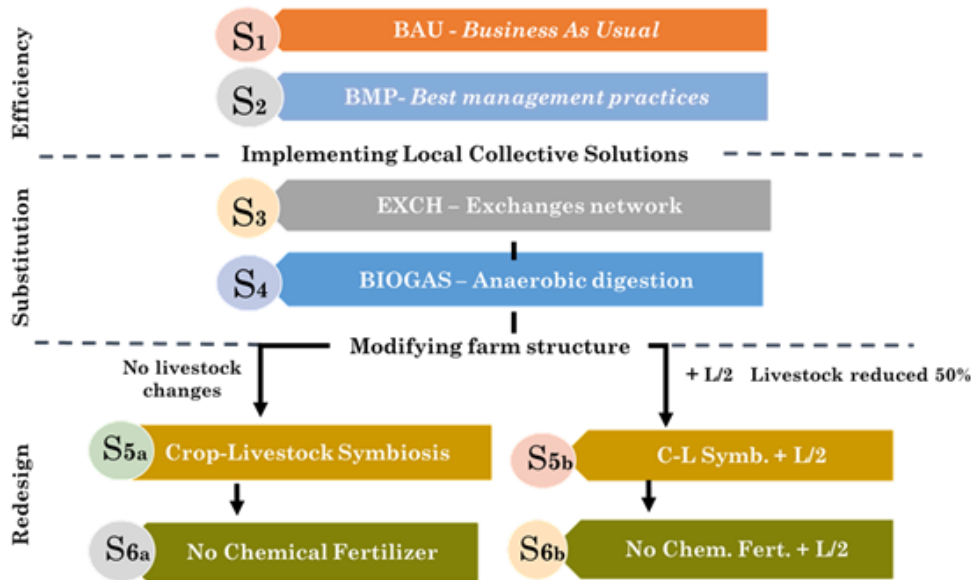

Figure 1. Scenarios explored in the Ribéracois case-study using the FAN model.

## RESULTS AND DISCUSSION

The production indicators calculated after FAN simulations include crop production, livestock production, and renewable energy production. In addition, the performance of the system is also measured through environmental indicators, including nutrient cycles and fertilization (Fig. 2), nutrient losses to water bodies, C sequestration and greenhouse gas emissions, and food and feed autonomy.

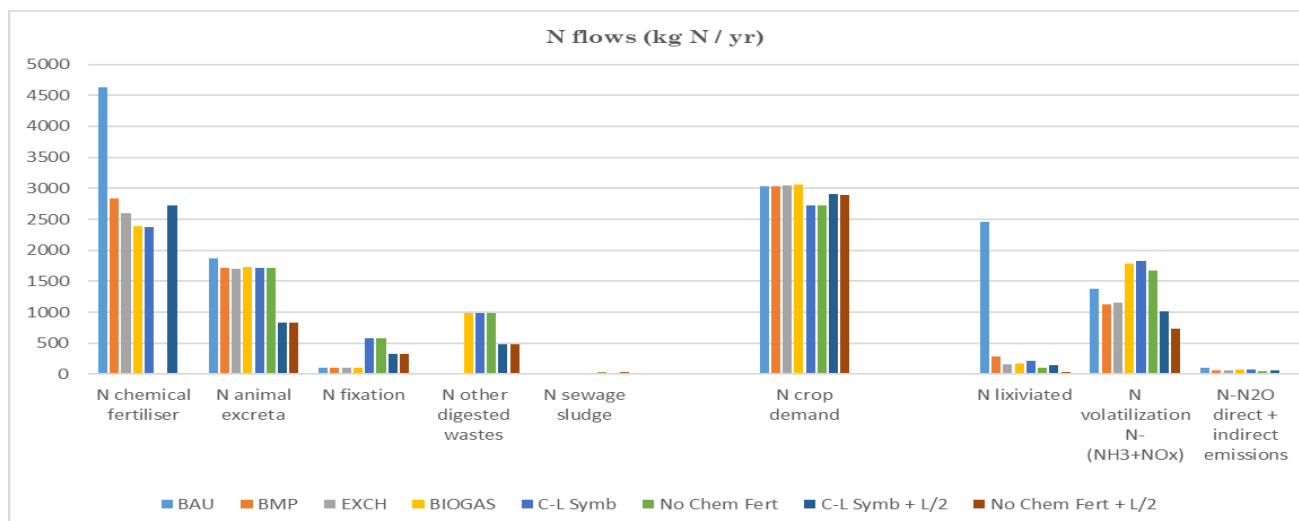

Figure 2. N flows from FAN scenarios output, in kg of N per year. N inputs to the system are on the left, and N outputs and losses on the right.

## CONCLUSION

The environmental performance of the scenarios increased progressively through their application. However, several variables showed that this progression was not straightforward and sometimes food production could be drastically reduced. This information gave an insight on how different choices and development strategies can make agro-food systems change and adapt to local environmental issues and what are the drawbacks and the gains.

## REFERENCES

- Davis, S.C., Kauneckis, D., Kruse, N.A., Miller, K.E., Zimmer, M., and Dabelko, G.D. (2016). Closing the loop: integrative systems management of waste in food, energy, and water systems. *J. Environ. Stud. Sci.* 6, 11–24.
- Fernandez-Mena, H., Nesme, T., Pellerin, S., 2016. Towards an Agro-Industrial Ecology: A review of nutrient flow modelling and assessment tools in agro-food systems at the local scale. *Sci. Total Environ.* 543, 467–479.
- Lassaletta, L., Billen, G., Grizzetti, B., Garnier, J., Leach, A.M., and Galloway, J.N. (2014a). Food and feed trade as a driver in the global nitrogen cycle: 50-year trends. *Biogeochemistry* 118, 225–241.
- Smith, J., Lang, T., Vorley, B., Barling, D., 2016. Addressing policy challenges for more sustainable local–global food chains: Policy frameworks and possible food “futures.” *Sustainability* 8, 299.

## **A COMPARISON OF DISAGGREGATED NITROGEN BUDGETS FOR DANISH AGRICULTURE USING EUROPE-WIDE AND NATIONAL APPROACHES**

KROS, J.<sup>1</sup>, HUTCHINGS, N.J.<sup>2</sup>, TOFT KRISTENSEN, I.<sup>2</sup>, SILLEBAK KRISTENSEN, I.<sup>2</sup>, DUUS BØRGESSEN, C.<sup>2</sup>, VOOGD, J.C.H.<sup>1</sup>, DALGAARD, T.<sup>2</sup>, DE VRIES, W.<sup>1,3</sup>

<sup>1</sup> Wageningen Environmental Research, Wageningen, Netherlands; <sup>2</sup> Department of Agroecology, Aarhus University, Tjele, Denmark; <sup>3</sup> Environmental Systems Analysis Group, Wageningen University, Wageningen, Netherlands

### **INTRODUCTION**

Spatially detailed information on nitrogen (N) budgets is relevant to identify regions with a need to significantly reduce N pollution. Furthermore, disaggregation to smaller areas (landscapes and/or catchments) is relevant since implementation of the Water Framework Directive and to a lesser extent the Nitrates Directive will lead to significant changes in land use and land management at this scale. However, at the scale of the European Union, there is a lack of consistent, reliable, high spatial resolution data necessary for the calculation of regional N losses. One model that has been used at European scale to assess high spatial resolution N budgets is the model Integrator (De Vries et al., 2011; Kros et al., 2012). Despite using this detailed information, the model might still be quite inaccurate at the regional level within countries. To gain insight in the reduction in uncertainty that could be achieved by using higher resolution input data, spatially disaggregated agricultural N budgets for Denmark for the period 2000-2010 were generated by Integrator, using both high spatial resolution national data (Integrator-DK) and data available at the European scale (Integrator-EU). Here we report the approach and results of this study, focusing on the years 2000 and 2010, for which the quality of the regional Danish input data was considered best. The results provide insight in the quality of European-scale model results at regional scale (within country level). We also compared the results at national scale with those obtained using Danish national data and a Danish modelling approach.

### **MATERIAL AND METHODS**

The Integrator-EU model, developed to assess N-flows at European level in response to changes in climate, land use and land management, was used to assess N flows for Denmark. Integrator-EU comprises 27 Member States, including Denmark, that are subdivided into so-called NitroEurope Classification Units (NCUs). These NCUs, about 40,000, are composed of multipart polygons, each of the polygons being a cluster of 1 km × 1 km pixels. Integrator predicts the N (NH<sub>3</sub>, NO<sub>x</sub>, N<sub>2</sub>O and N<sub>2</sub>) emissions and N leaching from housing and manure storage systems and agricultural soils. Integrator-EU calculates the total N manure production for each NCU using Eurostat data on animal numbers at the socio-economic NUTS3 level from Eurostat and excretion rates from CAPRI (Britz et al., 2014). Fertilizer N application is based on national fertilizer consumption rates for the year 2010. For each country, the mineral fertilizer is distributed over crops using weighing factors that are based on the N uptake of the crop. For the application of Integrator-EU with high spatial resolution national data for Denmark (DK) we developed Integrator-DK by (i) adaptation of the boundaries of the NCUs, (ii) adaptation of the manure distribution module and (iii) translation of the detailed Danish data, usually available at municipality level, to conform with the crop types and animal categories, used in Integrator.

### **RESULTS AND DISCUSSION**

Results showed that the national N fluxes in the N budgets calculated by the two versions of the model were within 1-5% for N inputs by fertilizer and manure excretion, but inputs by N fixation and N mineralisation differed by 50-100% and N uptake differed by ca 25%, causing a difference in N leaching and runoff by nearly 50%. Figure 1 presents a comparison of predicted N inputs and N losses by Integrator-EU and Integrator-DK for the year 2010



at 113 plots, where the Integrator-EU results for the 113 plots were compared with the mean of the corresponding Integrator-DK plots with underlying data of 610 plots.

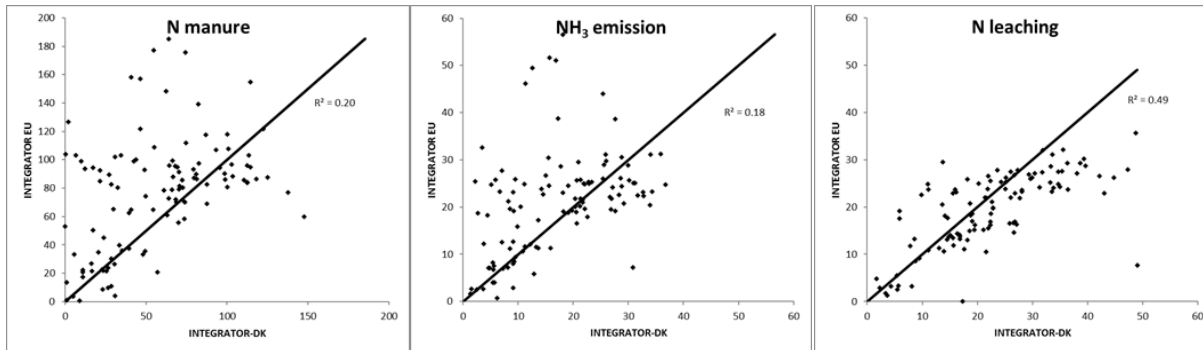

Figure 1 XY-plots for N input by animal manure, NH<sub>3</sub>-N emission and N leaching (in kg N ha<sup>-1</sup> yr<sup>-1</sup>) as calculated by Integrator-EU and Integrator-DK for the year 2010 together with the 1:1 line and the R<sup>2</sup> of linear regression between the Integrator-EU and Integrator-DK results

Results show a relatively large scatter around the 1:1 line, and a rather poor correspondence for manure application ( $R^2=0.21$ ) and NH<sub>3</sub> emission ( $R^2=0.18$ ) and reasonable correspondence for N leaching ( $R^2=0.48$ ). This means that the spatial distributions of Integrator-DK clearly differ from those of Integrator-EU. The spatial distribution of manure distribution and N losses from Integrator-DK were closer to observed distributions than those from Integrator-EU.

## CONCLUSION

Differences in spatial distribution between Integrator-EU and Danish results are mainly due to differences in the spatial distribution of livestock and the resulting manure distribution. This causes large differences between EU and DK versions in the spatial distribution of NH<sub>3</sub> emission and N leaching. Furthermore, differences in crop N offtake and leaching fractions used in Integrator causes large differences in N leaching and runoff. The incorporation of detailed national data rather than less detailed European data does, however, not necessarily result in more reliable national results. This comparative study between spatially detailed data based and generic national data based N budgets clearly illustrates the importance of good spatial resolution in input data. There is clearly a need for collection and submission of high resolution data from all Member States to EUROSTAT.

**Acknowledgement:** This project has been supported by the Strategic Research Alliance DNMARK ([www.dnmark.org](http://www.dnmark.org)) funded by The Danish Council for Strategic Research (reference 12-132421).

## REFERENCES

- Britz, W., Witzke, P., 2012. CAPRI model documentation, URL: [http://www.capri-model.org/docs/capri\\_documentation.pdf](http://www.capri-model.org/docs/capri_documentation.pdf). University of Bonn.
- De Vries W., Leip A., Reinds G.J., Kros J., Lesschen J.P., Bouwman A.F., Grizzetti B., Bouraoui F., Butterbach Bahl K., Bergamaschi P., Winiwarter W., 2011. Geographic variation in terrestrial nitrogen budgets across Europe. In: Sutton, M.A., Howard C.M., Erismann J.W., Billen G., Bleeker A., Grennfelt P., Van Grinsven H., Grizzetti B. (Eds). The European Nitrogen Assessment. Cambridge, Cambridge University Press, Cambridge, pp. 317-344.
- Kros J., Heuvelink G.B.M., Reinds G.J., Lesschen J.P., Ioannidi, V., De Vries W., 2012. Uncertainties in model predictions of nitrogen fluxes from agro-ecosystems in Europe. Biogeosciences 9-11, 4573-4588.

## NITROGEN MANAGEMENT IN FRENCH DAIRY SYSTEMS: EVALUATION AND ENHANCEMENT OF NITROGEN EFFICIENCY AND ECONOMIC PERFORMANCE

FORAY, S.<sup>1</sup>, VERTES, F.<sup>2</sup>, GODINOT, O.<sup>2</sup>

<sup>1</sup> Institut de l'Élevage, France; <sup>2</sup> INRA Agrocampus-Ouest UMR SAS, France

### INTRODUCTION

While nitrogen (N) management has improved significantly on livestock farms, with positive consequences for nitrate concentrations in surface waters (Manneville *et al.*, 2017), the French dairy farming sector must continue its efforts. At the same time, dairy farmers have to cope with market developments (increased milk demand), price volatility and changing agricultural policies. Therefore, reconciling respect for the environment and economic competitiveness has become one of their main objectives. To support them, the “Inosys-Réseau d'Élevage” farms network associates 2,000 breeders and 240 engineers to analyze the management of the farms and disseminate the knowledge and tools needed to improve the systems. The analysis of these farms' data aims to identify sustainable production systems and key actions that can be implemented by farmers to improve nitrogen (and phosphorus) management, related to economic performances (full results in Foray *et al.*, 2017).

### MATERIAL AND METHODS

Data used focus on the specialized dairy farms of the “Inosys” network for the years 2000-2004 and 2009-2013 and include a descriptive statistical analysis of several indicators of practices, emissions, and impacts related to N management. Five classes of dairy systems were described according to their production area (lowland vs mountain and piedmont) and their feeding systems: proportion of maize in the forage area <10%, 10 to 30%, >30%. A comparison between the most and least efficient systems regarding the nitrogen balance (Simon *et al.*, 2000) is conducted. N surplus are defined as nitrogen inputs including (except in table 1) symbiotic fixation and atmospheric deposition minus nitrogen outputs.

### RESULTS AND DISCUSSION

#### Intensification of dairy systems and environmental response

Despite the decrease in the number of dairy farm (-34% in 2015 compared to 2005), the national milk production has increased by around 9% between 2004/2005 and 2014/2015, reflecting both the evolution of the size of the dairy farms (France Agrimer, AGRESTE) and the intensification of dairy farms: more milk per cows (+ 595 l per cow per year) and more milk per ha of forage area (+ 434 l per ha of forage area). This intensification was achieved by an increase in feed concentrates.

However, the expansion and the intensification of the dairy farms have not led to a degradation of the nitrogen farm gate balance.

Table 1. Evolution of the milk production, feed concentrates intakes and N surplus between 2000-2004 and 2009-2013 – in the specialized dairy farms of Inosys Network data

	<i>Average 2000-2004</i>	<i>Average 2009-2013</i>	<i>P value</i>
Feed concentrates – kg per cow per year ( <i>g per l milk</i> )	1 388 (211)	1 590 (220)	< 0.01 (<0.03)
Milk production - l/cow/year ; l/ha forage area /year)	6 601 (6070)	7 196 (6 504)	< 0.05 (<0.05)
Livestock Unit - LSU/ha forage area	1.42	1.37	NS
N balance (without N fixation and atm. deposition)- kgN/ha	74	71	NS

Today, grazing systems (Maize < 10% forage area) have a moderate surplus of nitrogen compared to maize-based systems (Maize > 30 % forage area), in mountain areas ( $52\pm 23$  kgN.ha<sup>-1</sup> and  $101\pm 34$  kgN.ha<sup>-1</sup> respectively) as well as in lowlands ( $79\pm 36$  kgN.ha<sup>-1</sup> and  $118\pm 28$  kgN.ha<sup>-1</sup> respectively). Intra-system diversity (figure 1) highlights the high variability of N surpluses at farm level, showing the large diversity of nitrogen management practices (feeding, fertilization, manure management, grass and grazing management...) within each class. To understand the determinants of these differences, also dependent on soil and climate potentials, data of the 20% lowest and 20% highest N surplus farms were compared. Results focus on lowland farms with >30% maize in fodder area.

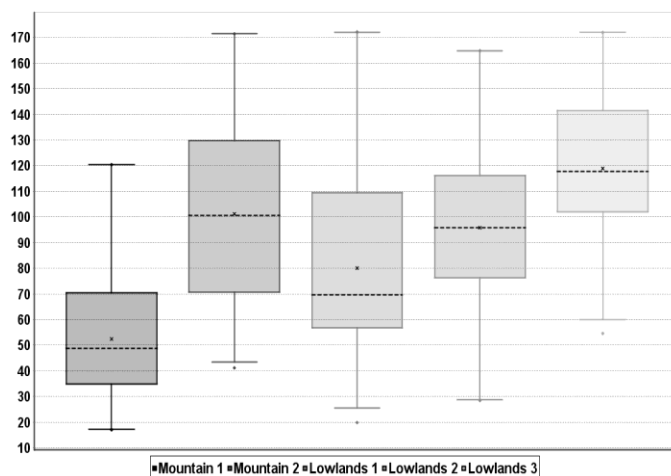

Figure 1. Nitrogen Balance in kgN.ha<sup>-1</sup> for the five French dairy systems, Inosys Network data, 2009-2013 (Mountain 1 <10% maize; Mountain 2 > 10% maize, Lowlands 1 < 10% maize, Lowlands 2 10 to 30% maize, Lowlands 3 > 30 % maize)

### Maize based systems: high and low performance farms

The 20% most performant farms show an average N surplus of  $79\pm 10$  kg N ha<sup>-1</sup> compared to  $152\pm 8$  kg N ha<sup>-1</sup> for the 20% less performant. These performant farms are slightly less intensive than the less performant for milk production, expressed per ha ( $8030\pm 2390$  l ha<sup>-1</sup> vs  $9520\pm 2738$  l ha<sup>-1</sup>) or per cow ( $7360\pm 994$  cow vs  $8040\pm 1022$  cow) (- 8% and - 15% respectively), but they have a higher ratio of gross operating surplus / gross product that reflects a better economic efficiency ( $36\pm 9\%$  vs  $28\pm 11\%$ ). The use of feed concentrates appears well managed considering the high milk production level, allowing a lower feeding cost  $91\pm 34$  € vs  $121\pm 38$  € (-25%). N fertilizer are used in a more parsimonious way within the most performant farms with a N mineral pressure of  $64\pm 28$  kg N ha<sup>-1</sup> compared to  $152$  kg N ha<sup>-1</sup>. Finally, their N efficiency at farm level (N output/N input) is 60% higher than the less performant ( $45\pm 11$  % vs  $28\pm 6$  %).

### CONCLUSION

The intensification of the French dairy system that occurred in the last decade was mostly permitted by a more efficient use of resources, leading to a more important milk production with less N losses. Higher animal feed self-sufficiency, greater fertilizer self-sufficiency and a larger proportion of grasslands generally result in higher farm N efficiency in our sample. It is thus likely that this difference between efficient and less efficient farms would be even greater if N efficiency also considered soil N variations, input production and purchased feed production (Godinot et al., 2014). The optimization of practices within each system offers opportunities to reduce the use of nitrogen inputs. Thus, a good balance can be found by adapting the diet as closely as possible to the needs and the potential production of the animals and controlling the nitrogen fertilization of crops, forage and grasslands.

**Acknowledgements:** We would like to thank the French Agency for the Biodiversity for funding this study; and J-L. Peyraud, V. Manneville, A. Le Gall, M. El Jabri, C. Billy and M. Dourthe for technical support.

## REFERENCES

- Foray S., Billy C, Manneville V., Dolle J-B., Le Gall A., Vertès F., Godinot O., 2017. Gestion de l'azote dans les systèmes d'élevages herbivores. Evaluation et amélioration de l'efficience de l'azote, réduction des transferts vers les milieux aquatiques. Collection Résultats Idele, 97p.
- Godinot O., Carof M., Vertès F., Leterme P. 2014. SyNE: an improved indicator to assess nitrogen use efficiency of farming systems. *Agricultural Systems* 127, 41–52.
- Manneville V., El Jabri M., Divo C., Foray S., 2017. Contribution de l'élevage d'herbivores à l'amélioration de la teneur en nitrates de l'eau en France. Collection Résultats Idele.
- Simon J-C., Grignani C, Jacquet A et al (2000) Typologie des bilans d'azote de divers types d'exploitation agricole: recherche d'indicateurs de fonctionnement. *Agronomie* 20, 2, 175-195.

**REGIONALIZED AMMONIA EMISSION REDUCTION POTENTIALS IN GERMANY**HÄUSSERMANN, U.<sup>1</sup>, KLEMENT, L.<sup>1</sup>, BACH, M.<sup>1</sup>, BREUER, L.<sup>1</sup><sup>1</sup> Justus-Liebig University Giessen, Institute for Landscape Ecology and Resource Management, Germany**INTRODUCTION**

The overall ammonia (NH<sub>3</sub>) emissions in Germany account for 759 kt NH<sub>3</sub> in 2015 and have increased in recent times. 95% of all NH<sub>3</sub> emissions in Germany originate from agriculture. In accordance with international treaties, EU legislation and national regulations, Germany committed to reduce the NH<sub>3</sub> emissions significantly. According to the UNECE Convention on Long-Range Transboundary Air Pollution (CLRTAP) and the NEC directive (2016/2284/EU), the NH<sub>3</sub> emissions reduction targets for Germany are set at to 5% and 29%, for 2020 and 2030, respectively, relative to NH<sub>3</sub> emissions in 2005 (678 kt) (Federal Environment Agency 2017).

Our aim is a) to evaluate mitigation options for agriculture with respect to their overall NH<sub>3</sub> emission reduction potential for Germany, b) their impact on net N surplus, and c) and to identify regional “hot spots” and trends for NH<sub>3</sub> emissions from agriculture and its sources.

**MATERIAL AND METHODS**

We developed a calculation scheme for gaseous emissions of nitrogen (N) species (NO<sub>x</sub>, N<sub>2</sub>, N<sub>2</sub>O, and NH<sub>3</sub>) from agriculture and for net N balances on a regional scale (Häußermann and Bach 2017). This calculation scheme is based on the accounting method of the agricultural part of the National Emission Inventory Report (Rösemann et al. 2017), therefore the results from this calculation scheme correspond to those from the National Emission Inventory Report. It provides the possibility to calculate gaseous emissions of nitrogen species and net N balances for 402 NUTS-III regions (districts), 16 NUTS-I regions (federal states) and entire Germany on a yearly basis for 1995 to 2015. Furthermore, the calculation separates three categories of agricultural activities: animal husbandry, biogas and crop production, as well as different compartments within these categories: e.g. farmyard manure (FYM) storage, FYM spreading and animal housing systems. Activities in all of these compartments affect the amount of gaseous emissions of N species from agriculture.

In our study, we calculated the impact of six mitigation measures (MM) for the three major livestock categories (cattle, pigs and poultry) on their respective NH<sub>3</sub> emission reduction potential and net-N balance (see table 1). MM for digested FYM, which accounts for approximately 18% of all excreted N from cattle, pigs and poultry in 2015 were not considered.

*Table 1. Ammonia emissions mitigation measure for animal husbandry (cattle, pigs and poultry).*

MM	Compartment	Species	Description
MM1	grazing	cattle	time spent on pastures increased
MM2	FYM storage	cattle, pigs and poultry	solid covers for all undigested slurry for all outdoor storage systems
MM3	FYM storage	cattle, pigs and poultry	solid covers for all undigested slurry + no slurry storage underneath slatted floors
MM4	FYM spreading	cattle, pigs and poultry	grassland: all undigested slurry applied with trailing hoses arable land: all undigested slurry applied with trailing hoses and incorporated within 1 hour optimal application technique for all undigested leachate and solid manure
MM5	housing	pigs	all slurry based pig barns are equipped with air scrubbers
MM6		cattle, pigs and poultry	combination of measures MM1, MM3, MM4 and MM5

## RESULTS AND DISCUSSION

NH<sub>3</sub> emissions from cattle, pigs and poultry FYM management and application account for 463 kt NH<sub>3</sub> (61% of total NH<sub>3</sub> emissions) in 2015. Increasing the time spent on pastures for cattle (MM1) reduces NH<sub>3</sub> emissions by 2.0% (relative to NH<sub>3</sub> emissions from major livestock species in 2005). Equipping all outdoor storage systems with solid (concrete) covers (MM2) reduces NH<sub>3</sub> emissions by 1.9%; not storing any slurry underneath slatted floors (MM3) increases reduction potentials to 3.2%. High reduction potentials can be achieved with emission efficient FYM application techniques. Spreading FYM with trailing hoses and incorporation of slurry and solid manure within one hour on bare soil (MM4) reduces NH<sub>3</sub> emissions by 13.8%. Equipping all slurry based housing systems for pig husbandry has the potential to reduce NH<sub>3</sub> emissions by 11.7%. The combination of mitigation measures MM1, MM3, MM4 and MM5 has the potential of NH<sub>3</sub> emissions reductions of 26.9% (see figure 1).

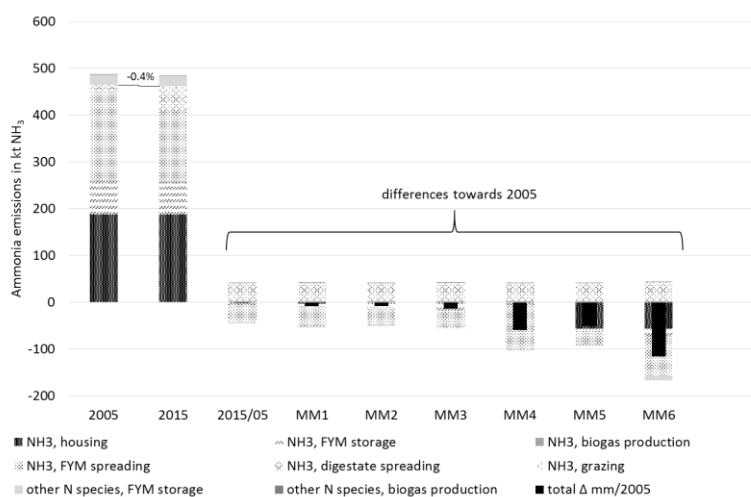

Figure 1. Total NH<sub>3</sub> emissions reduction potentials for mitigation measures in animal husbandry of livestock species cattle, pigs and poultry compared to NH<sub>3</sub> emissions in 2005.

## CONCLUSION

None of these mitigation measures suffices the emission reduction targets set by the CLRTAP and the EU-NEC directive (2016/2284/EU) for 2030. Implementing MM4, MM5 and MM6 might suffice to achieve the 2020 emission reduction targets for major livestock species, however might be difficult to implement within the short period until 2020. With respect to total NH<sub>3</sub> emissions, none of the described MM achieves even the 5% emission reduction target for 2020. Further steps should be considered to reduce total NH<sub>3</sub> emissions from German agriculture by 5% in 2020 and 29% in 2030.

## REFERENCES

- Häußermann U., Bach M. 2017. Berechnung von Stickstoff-Flächenbilanzen für Deutschland, Bundesländer und Kreise – Jahre 1995 bis 2015. Methoden und Ergebnisse. Stand Oktober 2017 (in preparation)
- Rösemann C., Haenel H.D., Dämmgen U., Freibauer A., Döring U., Wulf S., Eurich-Menden B., Döhler H., Schreiner C., Osterburg B. 2017. Calculation of gaseous and particulate emissions from German agriculture 1990 – 2015. Report on methods and data. Submission 2015. Thünen Report 46. Braunschweig. 372 p.
- Federal Environment Agency 2017. National Trend Tables for the German Atmospheric Emission Reporting 1990 – 2015. Dessau-Roßlau.  
[https://www.umweltbundesamt.de/sites/default/files/medien/361/dokumente/2017\\_02\\_15\\_em\\_entwicklung\\_in\\_d\\_trendtabelle\\_luft\\_v1.0.xlsx](https://www.umweltbundesamt.de/sites/default/files/medien/361/dokumente/2017_02_15_em_entwicklung_in_d_trendtabelle_luft_v1.0.xlsx)

## PRODUCTION, NITROGEN EXPORTATION AND NITRATE LEACHING FROM MANAGED GRASSLANDS IN FRANCE

GRAUX, A.-I.<sup>1</sup>, RESMOND, R.<sup>1</sup>, CASELLAS, E.<sup>2</sup>, DELABY, L.<sup>1</sup>, FAVERDIN, P.<sup>1</sup>, LE BAS, C.<sup>3</sup>, MEILLET, A.<sup>4</sup>, POMEON, T.<sup>4</sup>, RAYNAL, H.<sup>2</sup>, RIPOCHE, D.<sup>5</sup>, RUGET, F.<sup>6</sup>, THEROND, O.<sup>7</sup>, VERTES, F.<sup>8</sup>, PEYRAUD, J.-L.<sup>1</sup>

<sup>1</sup> INRA-Agrocampus Ouest, UMR 1348 PEGASE, France; <sup>2</sup> INRA, UR 0875 UBIA, France; <sup>3</sup> INRA, US 1106 INFOSOL, France ; <sup>4</sup> INRA, US 0685 ODR, France ; <sup>5</sup> INRA, US 1116 AGROCLIM, France; <sup>6</sup> INRA, UMR EMMAH, France; <sup>7</sup> INRA, UR 1132 LAE, France ; <sup>8</sup> INRA-Agrocampus Ouest, UMR 1069 SAS, France

### INTRODUCTION

This study (Graux et al., 2017) aims to quantify and map French grassland yield and N exportation resulting from cutting and grazing practices, for the existing diversity of grassland types, managements, soil and climate conditions, and to assess the risk of nitrate leaching associated with increasing applications of organic N (that include N applications by grazing animals). Results are intended to provide scientific elements supporting a French request for derogation from the actual organic N spreading limit, set in the Nitrate Directive at 170 kg of organic N per year and per hectare of Utilised Agricultural Area (UAA).

### MATERIAL AND METHODS

Observed data from regular grass measurements in four French regions were analysed to provide reference values of the grassland production and N exportation. This first assessment was extended to France by simulating grasslands with a research version of the STICS crop model (Brisson et al., 2003; Ruget et al., 2006), named PâturSTICS. This model simulates daily the dry matter (DM), the N and water fluxes involved in the functioning of grasslands and crops in response to management, soil and climate conditions. The planned cut and grazing events can be adapted in the course of the simulation according to predefined rules of management and effective simulated grass growth. STICS was improved to account for animal returns on grasslands during grazing, and to better simulate the DM production and protein content of grasses and legumes. Simulations were performed across France at a high resolution grid composed of pedoclimatic units (PCU) obtained by crossing the spatial resolutions of climate (SAFRAN data - 8 km grid) and soil (1/1,000,000-scale soil geographical database of France - Soil Mapping Units of variable size). Thanks to the French Land Parcel Identification System and to the French agricultural statistics, and based on previous work (Ruget et al., 2006), the main grassland types and associated managements were determined for each PCU, then simulated with PâturSTICS over 30 years (1984-2013). Annual simulation results were aggregated and analysed in the light of reference values. To go further, additional simulations testing the consequences of an intensification of grazing on nitrate leaching were performed in 6 French departments where conditions to obtain derogation would be potentially met.

### RESULTS AND DISCUSSION

The simulated yield and N exportation are in agreement with available reference values, with the exception of mountain regions where the model tends to overestimate observations, probably due to the non-inclusion in present simulations of the effects of snow and night frosts on grass growth and of slope on soil water resources. Most French grasslands export more than 170 kg N ha<sup>-1</sup> yr<sup>-1</sup> up to more than 400 kg N ha<sup>-1</sup> yr<sup>-1</sup>. The highest production ( $\geq 10$  t DM ha<sup>-1</sup> yr<sup>-1</sup>) and N exportation levels ( $\geq 200$  kg N ha<sup>-1</sup> yr<sup>-1</sup>) are observed in the following regions or departments: Bretagne, Normandie, Marne, Limousin, Vosges, Franche-Comté, the north-west part of Massif Central, French Alps and the west of Pyrénées (Figure 1). Among these productive situations, Finistère, Morbihan, Vosges and the west of Pyrénées are also presenting the highest risks for nitrate leaching (Figure 1). These high-risk situations result from high simulated water drainage ( $\geq 500$  mm yr<sup>-1</sup>) and soil N mineralisation ( $\geq 200$  kg N ha<sup>-1</sup> yr<sup>-1</sup>). The comparison of the observed (Vertès et al., 2007) and simulated responses of nitrate leaching to an increase of stocking rates showed that PâturSTICS tends to overestimate nitrate leaching, probably due to the

underestimation of soil N immobilisation and, to a lesser extent, to the possible slight overestimation of soil N mineralisation. However, the shape of the simulated response was in agreement with the observed curve, giving confidence in the analysis of the relative evolutions of risks in comparison with the Nitrates directive situation (170 kg organic N ha<sup>-1</sup> yr<sup>-1</sup>). Increasing the organic N spreading limit up to 200 kg N ha UAA<sup>-1</sup> yr<sup>-1</sup> should lead to a moderate increase of nitrate leaching (≤ 20 kg of supplementary N ha<sup>-1</sup> yr<sup>-1</sup>) from grasslands in most situations.

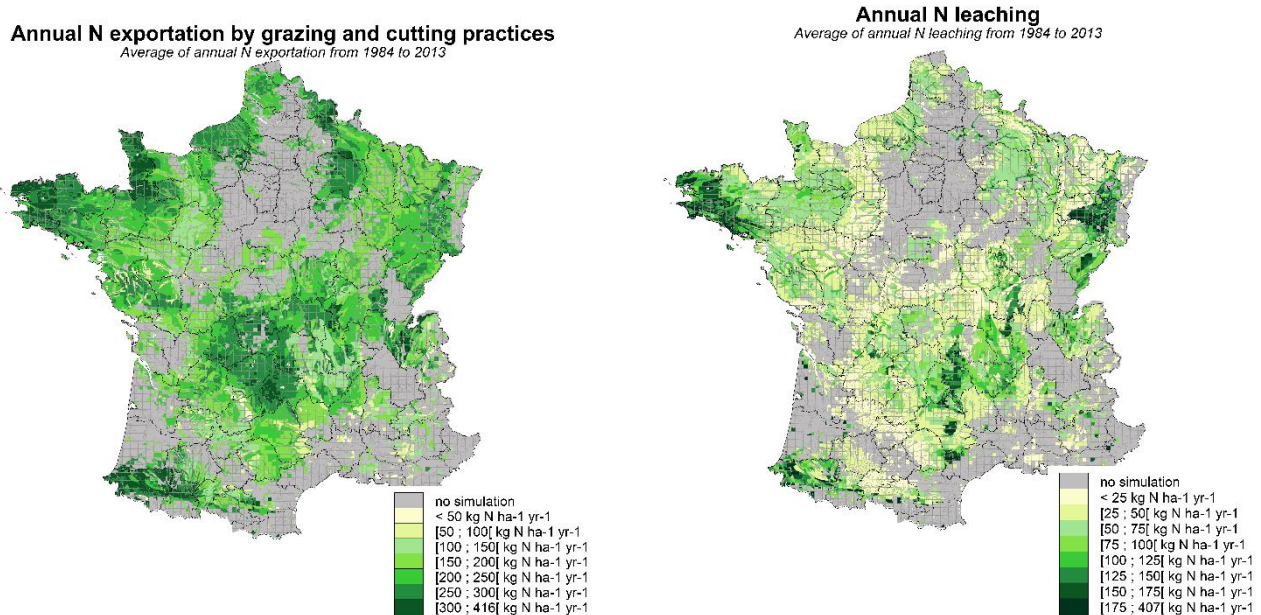

Figure 1. Simulated average annual N exportation and N leaching for French grasslands. Grey cells were not simulated as there are only few grassland surfaces at these locations. The variability of results linked to the diversity of grasslands, managements, soils and climate years is not presented here.

## CONCLUSION

This work allowed providing a very detailed view of French grassland production and N exportation, as well as the associated N leaching risk, taking into account the diversity of situations, both in case of the actual grass management and of an organic N spreading increase on grasslands. Our results provide information to consider derogation from the actual organic N spreading limit in productive areas that are not exposed to high environmental risks. Nevertheless, the present results have to be treated with caution as they are subject to a degree of uncertainty due to the quality of inputs and to the current modelling limits.

## REFERENCES

- Brisson N., Gary C., et al., 2003. An overview of the crop model STICS. *Eur. J. Agron.* 18, 309-332.
- Graux A.-I., Delaby L., Peyraud J.-L. (coordinateurs) et al., 2017. Les prairies françaises: production, exportation d'azote et risques de lessivage. Rapport d'étude, INRA (France), 75 p.
- Ruget F., Novak S. et al., 2006. Du modèle STICS au système ISOP pour estimer la production fourragère. *Adaptation à la prairie, application spatialisée.* *Fourrages*, 186, 241-256.



## **SYNERGY: A MODEL TO ASSESS THE ECONOMIC AND ENVIRONMENTAL IMPACTS OF INCREASING REGIONAL PROTEIN SELF-SUFFICIENCY**

JOUAN, J.<sup>1</sup>, CAROF, M.<sup>2</sup>, RIDIER, A.<sup>1</sup>

<sup>1</sup> SMART-LERECO, AGROCAMPUS OUEST, INRA, 35000 Rennes, France; <sup>2</sup>SAS, AGROCAMPUS OUEST, INRA, 35000 Rennes, France

### **INTRODUCTION**

The European Union (EU) relies on imports to feed livestock. In particular, protein self-sufficiency in EU for feed is not reached. Most of imported protein rich feed consist of soybean meals, which raises questions in terms of deforestation in countries where soybean is grown, consumer expectations for GMO-free products and security of supply. In this context, the 2014 CAP aims at improving protein self-sufficiency in EU for feed by developing production of protein-rich crops, such as legumes. Nevertheless, the development of legumes still faces economic and environmental challenges (Watson et al., 2017), such as lower annual gross margins per hectare than those of major crops and regulatory constraints which prohibit the spreading of animal manure on most legumes.

The purpose of this paper is to implement an appropriate stylized framework to assess the impacts of increased protein self-sufficiency through legume development at the regional level. Both economic and environmental impacts have to be studied. Mathematical programming models offer a prospective analysis, which permits to assess agricultural practices even though they have not been introduced at large scale yet. Among mathematical programming, bio-economic models permits to assess both economic and environmental impacts. In the case of legume production, several bio-economic models have been conducted, at the field scale and at the farm scale (Schläfke et al., 2014). Such models are relevant because decision-making processes take place at the farm scale and because they help appraising farm's sustainability. However, they fail to give indicators at higher scales, while this may be useful to policy makers. Hybrid models (Britz et al., 2012) address this issue by aggregating results from the farm to the region. These models usually take into account the diversity of farms but they badly represent the heterogeneity of soil and climate conditions. In the case of legume production, conditions such as soil pH and water deficit have to be taken into account because they limit the possibilities of implanting legumes. Besides, one of the levers to increase the production of legumes has been very little studied: the complementarity of farms. On the one hand, livestock farms could export animal manure to crop farms, which are deficient in nitrogen for crop fertilization. On the other hand, crop farms could produce legumes and trade it in order to feed animals of livestock farms. Our hypothesis is that increasing protein self-sufficiency through legume exchanges between farms can have positive economic and environmental impacts.

### **MATERIAL AND METHODS**

The bio-economic model SYNERGY proposed here is in direct line with these considerations. First, it is a hybrid model implemented at farm scale and then, aggregated at the regional level. Second, it takes into account various types of farm (crop farm, dairy farm, hog farm) as well as the heterogeneity of soil and climatic conditions. Third, the complementarity of farms is highlighted by accounting for exchanges of legumes and animal manure between farms. SYNERGY optimizes the sum of each farm's expected income at the regional level. It is composed of five modules: four modules describe farm activities (i.e., the cropping module, the fertilization module, the livestock module and the feeding module). Thanks to farm activities, farmers produce commodities (i) to self-supply needs for their management systems (e.g., a livestock farmer can use crops grown on its farm to feed his animals) and, (ii) to sell them on markets. Depending on the commodity, commodities can be exchanged on either local markets (i.e., to other farms of the region), on worldwide market or on both markets. The fifth module permits to assess environmental impacts through nitrogen-related indicators: SyNE (System Nitrogen Efficiency) and SyNB (System N Balance) based on (Godinot et al., 2014) have been integrated.

SYNERGY is implemented on a stylized area inspired from a part of western France where livestock farms are dominant. Three scenarios are simulated: the baseline scenario (B), which should reproduce the observed data; the scenario (SC1) where local exchanges between farms are made possible; the scenario (SC2) where, in addition to these local exchanges, a GMO-free certification is implemented for animal commodities for produced from legume-based rations instead of soybean-based rations. SYNERGY generates three types of outputs: (i) an assessment of protein self-sufficiency in animal feed, (ii) an economic assessment by calculating incomes and, (iii) an environmental assessment by calculating the nitrogen-related indicators SyNE and SyNB. All these assessments are done at the farm scale, and at the regional level through a scaling process.

## RESULTS AND DISCUSSION

SYNERGY model currently incorporates limited and highly constrained technical alternatives (i.e., soybean-based ration vs legume-based). Thus, the first results can only be interpreted in relation to the trends they present. When local exchanges between farms are possible (scenario SC1), protein self-sufficiency rises at the regional level (i.e., a part of western France), as do incomes. However, this greater self-sufficiency is not associated with an increase in the legumes area, but only with local exchanges of cereals. Thus, protein self-sufficiency is not only linked with protein rich materials but must be seen in a more comprehensive way by taking into account all sources of proteins. When a GMO-free certification is added (scenario SC2), the legumes area increases significantly and exchanges of legumes between crop farm and livestock farms happen. Protein self-sufficiency is improved thanks to a substitution of soybean-based rations for legume-based rations. However, the self-sufficiency is not strengthened compared to scenario SC2. One of the reason is that the legume-based ration for pig is less effective than the soybean-based ration. Concerning the environmental assessment, in both SC1 and SC2 scenarios, SyNE indicator decreases and SyNB indicator increases in all types of farms. Thus, farms become less efficient in N and N losses become higher than in the baseline scenario (B).

## CONCLUSION

The purpose of this paper was to implement an appropriate stylized framework to assess the impacts of increased protein self-sufficiency through legume development at the regional level. The results show that protein self-sufficiency can initially be strengthened at the regional level, thanks to local exchanges of cereals. It can also be enhanced to the same extent by the development and exchanges of legumes, when a market for differentiated feeds such as GMO-free animal products, exists. Thus, SYNERGY model highlights that the complementarity between livestock farms and crop farms is a relevant lever for improving regional protein self-sufficiency.

## REFERENCES

- Britz W, van Ittersum M, Lansink AO, Heckeleei T. Tools for Integrated Assessment in Agriculture. State of the Art and Challenges. *Bio-Based and Applied Economics* 2012;1:125–50. doi:10.13128/BAE-11232.
- Godinot O, Carof M, Vertès F, Leterme P. SyNE: An improved indicator to assess nitrogen efficiency of farming systems. *Agricultural Systems* 2014;127:41–52. doi:10.1016/j.agsy.2014.01.003.
- Schläfke N, Zander P, Reckling M, Bachinger J, Hecker J-M. Evaluation of legume-supported agriculture and policies at farm level. *Legumes Futures Report 4.3.*, 2014.
- Watson CA, Reckling M, Preissel S, Bachinger J, Bergkvist G, Kuhlman T, et al. Chapter Four - Grain Legume Production and Use in European Agricultural Systems. In: Sparks DL, editor. *Advances in Agronomy*, vol. 144, Academic Press; 2017, p. 235–303. doi:10.1016/bs.agron.2017.03.003.

## **MODEL ASSESSMENT AND VALIDATION OF AMMONIA CONCENTRATIONS AT HIGH SPATIAL AND TEMPORAL RESOLUTION OVER EUROPE**

GE, X.<sup>1</sup>, SCHAAP, M.<sup>2</sup>, KROS, J.<sup>3</sup>, KRANENBURG, R.<sup>2</sup>, SEGERS, A.J.<sup>2</sup>, DE VRIES, W.<sup>1,3</sup>

<sup>1</sup> Environmental Systems Analysis Group, Wageningen University and Research, Wageningen, Netherlands; <sup>2</sup> Department of Climate, Air and Sustainability, TNO, Utrecht, Netherlands; <sup>3</sup> Wageningen Environmental Research, Wageningen, Netherland

### **INTRODUCTION**

Ammonia emissions to the atmosphere have increased substantially in Europe since 1960, largely due to agricultural practices including intensive livestock production and the use of nitrogen fertilizers. These practices have enhanced deposition of ammonia and ammonium in the form of solutes, gases and particles, causing negative societal impacts on public health and terrestrial ecosystems. Due to the limited availability of ground-based measurements, models are used to assess large-scale ammonia emissions from agriculture. The modeled emissions are in turn used in chemistry transport models (CTMs) to assess ammonia concentration and deposition. One of the CTMs, LOTOS-EUROS, combined with the MACC-III emission model, is used to create grid maps of annual ammonia emissions over Europe at a spatial resolution of 7km x 7km (Kuenen et al., 2014). However, MACC-III does not distinguish differences in crop types, housing and storage systems and manure application techniques in its spatial allocation. Furthermore, it utilizes very simple parameterizations for the seasonal variation to allocate ammonia emissions over the year, not taking into account temporal variations in local agricultural management. This limits the capability to reproduce observed spatial and seasonal variations in the ammonia concentrations of rural regions with agricultural activities.

This paper describes the application of available novel ammonia emission approaches, that quantify emissions from agriculture at a higher spatial and temporal detail, within LOTOS-EUROS, to improve modeled ammonia emissions over Europe. The potential improvement was evaluated by comparing ammonia surface concentrations and total columns calculated by LOTOS-EUROS with ground-based measurements and IASI satellite observations.

### **MATERIAL AND METHODS**

#### **Improving the spatial resolution in annual ammonia emissions**

The higher spatial detail in annual ammonia emissions was realized by embedding the ammonia emission module of INTEGRATOR into MACC-III. INTEGRATOR is a model that assesses greenhouse gas and nitrogen fluxes from agricultural sectors at high spatial resolution and accounts for differences in crop types and grass, grazing, manure application and housing and storage systems (De Vries et al., 2011; Kros et al., 2011). The emissions in INTEGRATOR are calculated for polygons with unique combinations of major land use and soil types (co-called NCUs) being multiples of 1km x 1km grid cells in the reference system of ETRS89, while MACC-III emissions are gridded at 7 km x 7km in World Geodetic System 1984 (WGS84). Therefore, emission estimates from INTEGRATOR were transformed into WGS84. By slicing and reallocating INTEGRATOR emissions onto regular MACC-III grids, a map of ammonia annual total emission over Europe was retrieved, with a higher spatial resolution and distinguishing different crop types, housing and storage systems.

#### **Improving the temporal resolution in ammonia emissions over the year**

The much more detailed temporal distribution of ammonia emissions over the year was derived by the integration of the TIMELINES model (Hutchings et al., 2012), which provides predictions of timelines of key agricultural operations, such as fertilization, across Europe. The output used is the Julian day of fertilizer and/or manure application together with information about fertilizer type, amount of ammonium, nitrate or organic nitrogen, and application method, which all have impact on the ammonia emission factors over the course of one year. A

new algorithm was developed based on the above factors, as well as the difference between day and night, weekday and weekend.

## RESULTS AND DISCUSSION

The calculated total ammonia columns obtained from the renewed ammonia emission estimates showed a better correspondence with the IASI satellite observations than the ones retrieved with the original MACC-III results. The mean and standard deviation of difference between renewed estimates and remotely sensed data were 39.8% and 23.1% smaller than the original estimates, respectively. Furthermore, at selected ground stations from the European Monitoring and Evaluation Program (EMEP) framework, newly modeled surface ammonia concentrations over the year demonstrate closer temporal variations with in-situ measurements.

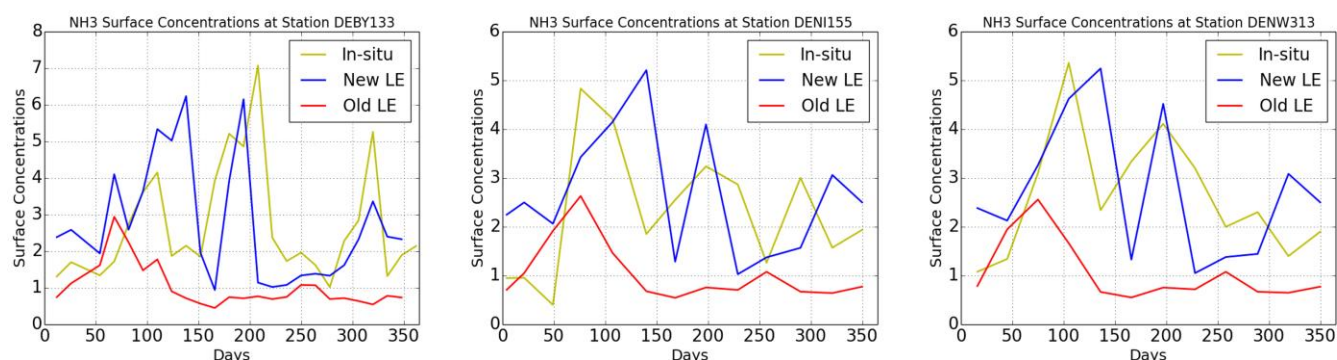

Figure 1. Comparison of ammonia surface concentrations from in-situ measurements and estimates obtained by LOTOS-EUROS with emission inputs from old MACC-III and renewed model.

## CONCLUSION

The adapted LOTOS-Euros model, including high spatial and temporal resolution ammonia emissions by combining three models – MACC-III, INTEGRATOR and TIMELINES leads to improved 4D maps (in space and time) of ammonia concentrations over Europe. This is indicated by a closer comparison with satellite observations and in-situ measurements. At current stage, the temporal allocation needs more refinement to give better results.

**Acknowledgements:** This research has been supported by the NWO funded project AMARETTO (reference ALW-GO/16-02).

## REFERENCES

- De Vries W., Leip A., Reinds G.J., Kros J., Lesschen J.P., Bouwman A.F., 2011. Comparison of land nitrogen budgets for European agriculture by various modeling approaches, *Environmental Pollution*, 159-11, 3254-3268.
- Kros, J., Frumau K.F.A., Hensen A., De Vries W., 2011. Integrated analysis of the effects of agricultural management on nitrogen fluxes at landscape scale, *Environ. Pollut.*, 159-11, 3171-3182.
- Hutchings, N.J., Reinds G.J., Leip A., Wattenbach M., Bienkowski J.F., Dalgaard T., Dragosits U., Drouet J.L., Durand P., Maury O., De Vries W., 2012. A model for simulating the timelines of field operations at a European scale for use in complex dynamic models. *Biogeosciences*, 9, 4487-4496.
- Kuenen J. J. P., Visschedijk A. J. H., Jozwicka M., Denier van der Gon H. A. C., 2014. TNO-MACC\_II emission inventory; a multi-year (2003–2009) consistent high-resolution European emission inventory for air quality modelling, *Atmos. Chem. Phys.*, 14, 10963-10976.

## USING THE BOTTOM-UP INVENTORY METHOD CADASTRE\_NH3 TO ASSESS THE EFFICIENCY OF MITIGATION TECHNIQUES TO REDUCE AMMONIA EMISSIONS IN FRANCE

DUFOSSE, K.<sup>1</sup>, GILLIOT, J.-M.<sup>1</sup>, RAMANANTENASOA M. M. J.<sup>1</sup>, VOYLOKOV P.<sup>1</sup>, GENERMONT, S.<sup>1</sup>, BESSAGNET, B.<sup>2</sup>

<sup>1</sup> UMR EcoSys; INRA; AgroParisTech, Université Paris-Saclay, France; <sup>2</sup> INERIS, France

### INTRODUCTION

France is one of the higher ammonia (NH<sub>3</sub>) emitting countries in Europe, and this gas comes mostly from the agricultural sector (97%) (CITEPA, 2017). It mainly derives from the livestock sector, but building and effluent storage emissions can easily be measured thus improving the estimates. However, due to their high nutrient content, animal effluents are used as fertilisers in arable fields and meadows. Due to different local pedoclimatic conditions, NH<sub>3</sub> emission varies highly at the national scale. When it reacts with industrial or vehicle emissions, NH<sub>3</sub> contributes to the formation of fine particle matter (PM<sub>2.5</sub>), a highly potent air pollutant having adverse impacts on human health. Mitigation to decrease NH<sub>3</sub> emissions measures have been proposed since 1999 through the Gothenburg protocol. However, due to the high variability in emissions from field-applied fertilizers and manures, the efficiency of these measures is difficult to assess at national scale.

The aim of this study is to show how the application of a bottom-up method (CADASTRE\_NH3, Ramanantenasoa *et al.* in review) on the proposed mitigation scenarios is an asset for the evaluation of the efficiency of the NH<sub>3</sub> emission reduction.

### MATERIAL AND METHODS

Our approach relies on the use of three resources: a national survey, a modelling tool and a guidance document. Nitrogen fertilization management data were derived from the national AGRESTE survey of cultural practices for arable crops and grassland, conducted by the Department of Statistics and Forecasting of the French Ministry of Agriculture, during the crop years 2010/2011, for the 13 main crops and 21 regions (NUTS2) (AGRESTE, 2014). From this survey, statistical calculations were carried out to aggregate representative cultural practices at a regional scale [cf. abstract “An overview of nitrogen fertilisation practices in France” in the poster session].

CADASTRE\_NH3 is a tool based on the Volt’Air model. The latter is a process-based 1D model predicting NH<sub>3</sub> emissions from N fertilizers on bare soils, from physical, chemical and biological processes. It takes into account the influence of soil, meteorological and agricultural variables and runs at an hourly time step at the field scale for a period of several weeks (Garcia *et al.* 2012). Simulation units (SU) were determined using a Geographical Information System, as the intersection of departments (NUTS3) and homogenous agricultural regions (AR), thus creating 713 SU. Local features were attributed to each SU: local pedoclimatic conditions, the area of each surveyed crop and the corresponding N fertilizing practices. All details about this method can be found in Ramanantenasoa *et al.* (in review).

Based on the guidance document for preventing and abating ammonia emissions from agricultural sources of the Gothenburg protocol (ECE/EB.AIR/113/Add.1, decision 2012/11), the two following scenarios will be applied to the N fertilisation practices and their efficiency will be evaluated:

- Scenario 1: Substitution of 60% of urea by ammonium nitrate
- Scenario 2: Abatement techniques for slurry and solid manure application (injection, incorporation within 24h of application, band-spreading)

Initial results have been calculated using (i) the AGRESTE survey data for the amount of mineral N applied in whole France in 2010-11, and (ii) the EMEP/EEA (2013) Tier 2 emission factors (EF) for NH<sub>3</sub> emissions in the field.

Abatement factors for Scenario 2 (organic fertilizers) come from the Gothenburg protocol. Simulations will be run through CADASTRE\_NH3 to sharpen the efficiency of these measures, taking into account the local pedoclimatic conditions. The outcomes of these simulations will be presented at the workshop.

## RESULTS AND DISCUSSION

As an example of results obtained using EMEP EF, Scenario 1 (substitution of 60% of urea by ammonium nitrate) demonstrates a reduction of 14% in NH<sub>3</sub> emissions (from 204 to 176 kgNH<sub>3</sub>) at the national scale (Table 1). However, even if urea represents 10% of the total mineral N applied in France, this ratio varies enormously amongst the regions (from 1% to 48%). Therefore, more local incentive could be implemented to help the implementation of the substitution where greater urea amounts should be substituted. Besides, this analysis did not consider the local pedoclimatic conditions that could impact greatly the NH<sub>3</sub> emissions rates and thus increase the regional disparity or affect the efficiency of this mitigation scenario.

*Table 1. Amount of mineral N fertilizer applied (in tN) and distribution between the main forms (urea and ammonium nitrate, in % of N applied) from the survey, estimates of NH<sub>3</sub> emissions (in ktNH<sub>3</sub>) from EF (EMEP/EEA, 2013) for the product distribution from the survey and for Scenario 1. The table presents a selection of 3 contrasted regions.*

Example of region (NUTS2)	Total N applied (tN)	Distribution of N products		Calculated total NH <sub>3</sub> emissions (EMEP method) (ktNH <sub>3</sub> )		Simulated total NH <sub>3</sub> emissions (CADASTRE_NH3) (ktNH <sub>3</sub> )	
		Urea	Ammonium nitrate	Survey	Scenario 1	Survey	Scenario 1
BOURGOGNE	111 424	9%	51%	10	9	12	11
PICARDIE	157 245	1%	48%	13	13	27	27
AQUITAINE	84 398	51%	31%	13	8	10	8
<b>Total</b>	<b>1 792 573</b>	<b>11%</b>	<b>51%</b>	<b>166</b>	<b>142</b>	<b>241</b>	<b>215</b>

## CONCLUSION

A complete bottom-up modelling will produce more accurate results of NH<sub>3</sub> emissions from local conditions than using fixed EF. The efficiency and pertinence of each proposed mitigation measure can be assessed for each French region individually. This will help to direct incentives or compensation measures depending on local contexts. Moreover, the effects of other mitigation measures could be tested, such as an application of closed restriction periods (to avoid peak pollution) or area limitations (to minimize environment contamination).

**Acknowledgements:** This work was supported by a public grant overseen by the French National Research Agency (ANR) as part of the « Investissements d'avenir » program (reference: ANR-10-EQPX-17 – Centre d'accès sécurisé aux données – CASD). It was conducted within the PolQA project (Mitigation policies to improve air quality through agricultural practices, agreement n°1662C0023), supported by the French PRIMEQUAL program (Programme de recherche interorganisme pour une meilleure qualité de l'air à l'échelle locale), by the French Environment and Energy Management Agency (ADEME) and by the French Ministry for an Ecological and Solidary Transition.

## REFERENCES

- AGRESTE, 2014. Enquête Pratiques culturales 2011 - Principaux résultats. *In* Les Dossiers N° 21 - July 2014. pp.72.
- CITEPA, 2017. "National inventories of air emissions in France: organisation and methodology.", OMINEA report - 14th ed. 838 p. <https://www.citepa.org/en/activities/emission-inventories/ominea>
- EMEP/EEA, 2013. Air pollutant emission inventory guidebook 2013: Crop production and agricultural soils. Technical report N° 12/2013. pp. 43.
- Garcia L., Générmont S., Bedos C., Simon N. N., Garnier P., Loubet B., and Cellier P., 2012. Accounting for Surface Cattle Slurry in Ammonia Volatilization Models: The Case of Volt'Air. *Soil Sci. Soc. Am. J.* 76(6), 2184-2194.

Session II: Regional studies - Highlighted posters

Ramanantenasoa M.M.J., Générumont S., Gilliot J.-M., Mignolet C., Bedos C., Mathias E., Eglin T., Makowski D., 2018. A process-based framework to estimate the spatio-temporal ammonia emissions due to nitrogen fertilization management. *Sci. Total Environ.* [in review].

**ESTIMATION OF THE GROWTH OF NH<sub>3</sub> EMISSIONS FROM ANAEROBIC DIGESTION IN THE UK**TOMLINSON, S.J.<sup>1</sup>, SCHMIDT-HANSEN, A.<sup>2</sup>, SUTTON, M.<sup>1</sup>, TANG, Y.S.<sup>1</sup>, DRAGOSITS, U.<sup>1</sup><sup>1</sup> Centre for Ecology & Hydrology, Edinburgh, UK; <sup>2</sup> University of Edinburgh, Edinburgh, UK**INTRODUCTION**

Anaerobic Digestion (AD) is an organic treatment technology for biological materials to produce energy and heat from biogas and nitrogen-rich (N) fertiliser by-products known as digestates. The European Commission (EC, 2016) estimated biogas production to be in the region of 15 Mt of oil equivalent at the start of 2015, with over three quarters of the activity taking place in Germany, the United Kingdom (UK) and Italy. Digestate production through AD can act as a closed loop recycling system for mineral nutrients such as N, its application to fields can restore soil organic matter and production can be a sustainable practice (Tiwarly *et al.*, 2015). However, due to the higher fraction of ammoniacal N in digestates and their (usually) elevated pH, there is a higher potential for N losses through ammonia (NH<sub>3</sub>) volatilisation, compared with undigested materials.

NH<sub>3</sub> emissions in Europe, which are responsible for the eutrophication and acidification of ecosystems, are dominated by the agricultural sector. In the UK, the AD industry has experienced rapid growth from around 32 plants in 2009 (processing circa 1 Mt of materials) to 400 plants at the end of 2016 (processing over 10 Mt of materials), with sectoral growth in the UK aided through government schemes. Given the rapid growth and large potential for NH<sub>3</sub> emissions, research has been carried out to quantify UK emissions from AD in detail, especially with regard to the impact of AD sources on the UK's National Emissions Ceilings. Emissions estimates are required to inform future policy surrounding the AD sector and are vital for developing effective mitigation strategies.

**MATERIAL AND METHODS**

Information on AD sector activity in the UK was compiled regarding site throughput, materials processed and locations (Tomlinson *et al.*, 2017). The data were processed to remove information not considered relevant to NH<sub>3</sub> emissions calculations due to their very large volumes and very low N content – primarily brewery/distillery effluents. NH<sub>3</sub> emissions were calculated for activity at the AD plant itself (site-based processes) and also for the subsequent landspreading of digestates using emission factors (EFs) as shown in Table 1 (Bell *et al.*, 2016; Nicholson *et al.*, 2017).

*Table 1. Emission Factors for Ammonia Emissions Estimates. Emission Factors (EFs) used (with ranges) in various stages of anaerobic digestion (AD) process to calculate ammonia emissions estimates.*

Anaerobic Digestion: Stage and Activity		EF	Unit	Range
Site-based	Pre-digestion storage	0.005	kg NH <sub>3</sub> t <sup>-1</sup>	0.003 – 0.008
	Digestion of materials	0.004	feedstock	0.002 – 0.006
	Post-digestion storage	0.059	fresh weight	0 – 0.24
Landspreading	Food only digestates	0.83	kg NH <sub>3</sub> t <sup>-1</sup>	-
	Crop/slurry/mixed digestates	2.13	digestate	1.82 – 2.43

NH<sub>3</sub> emissions were subsequently spatially distributed in the UK onto suitable land use types (arable and improved grassland) within a varying distance of each AD plant, using a function of the quantity of digestate produced.

**RESULTS AND DISCUSSION**



Figure 1 shows the estimated total NH<sub>3</sub> emissions from AD in the UK from 1990 to 2016. NH<sub>3</sub> emissions estimates for 2016 are 9.8 kt (range 8.3 kt – 12.3 kt), roughly double the estimate for 2013. It is estimated that around 90% of NH<sub>3</sub> emissions from the AD sector are from the spreading of digestates to land, due to the higher ammoniacal N content. The strength of emissions varies, due to, for example, some plants specializing in processing large amounts of high-N food waste materials.

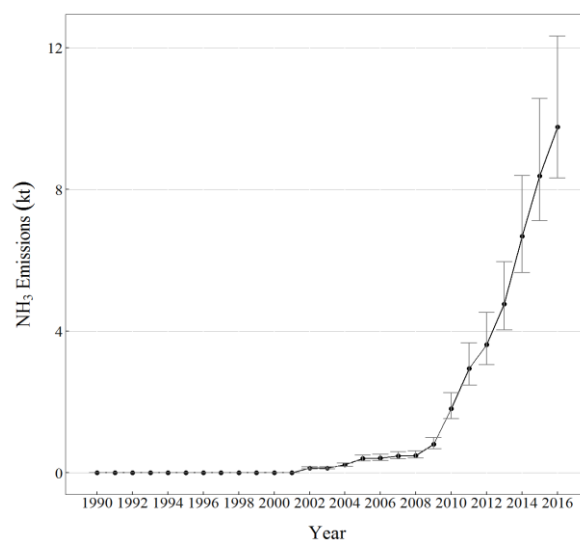

Figure 1. Estimated Emissions of Ammonia from Anaerobic Digestion in the UK. Estimated emissions of ammonia (NH<sub>3</sub>) from anaerobic digestion (AD) in the United Kingdom from 1990 to 2016 in kilotons (both site-based process emissions and digestate field spreading emissions). Low and high estimates indicated by error bars (grey).

There are a number of uncertainties that may effect NH<sub>3</sub> estimations, including robust quantification of the methods by which digestate is applied to land (e.g. shallow injection vs. band spreading), the wide ranging effects that co-digestion of differing materials may have on N-content and pH, and what type of soils and land cover digestate is applied to. Furthermore, mitigation strategies such as the acidification of digestates (to lower the volatilization rate of NH<sub>3</sub>) and better soil incorporation techniques may have a large reduction effect in NH<sub>3</sub> emissions to the atmosphere. Work is being undertaken to explore the effect some of these mitigation strategies may have on current and future estimates.

## CONCLUSION

Emissions of NH<sub>3</sub> from AD in the UK are a growing trend, with potentially a further 5 Mt of materials going to digesters in 2018, in addition to the current 10 MT. This may be an issue for the UK's ability to meet its national emissions ceilings, but could be addressed with targeted mitigation strategies. The UK Clean Growth Strategy states a desire for the UK to develop its bioeconomy but this must be done with forethought to future NH<sub>3</sub> emissions.

## REFERENCES

- Bell, M. W., Tang, Y. S., Dragosits, U., Flechard, C. R., Ward, P. and Braban, C. F. (2016). Ammonia emissions from an anaerobic digestion plant estimated using atmospheric measurements and dispersion modelling, *Waste Management*, 56, 113–124.
- European Commission, 2016. Optimal use of biogas from waste streams. An assessment of the potential of biogas from digestion in the EU beyond 2020, viewed 26 Jan 2018, [https://ec.europa.eu/energy/sites/ener/files/documents/ce\\_delft\\_3g84\\_biogas\\_beyond\\_2020\\_final\\_report.pdf](https://ec.europa.eu/energy/sites/ener/files/documents/ce_delft_3g84_biogas_beyond_2020_final_report.pdf).

- Nicholson, F., Bhogal, A., Cardenas, L., Chadwick, D., Misselbrook, T., Rollett, A., Taylor, M., Thorman, R. and Williams, J. (2017). Nitrogen losses to the environment following food-based digestate and compost applications to agricultural land, *Environmental Pollution*, 228, 504-516. doi: 10.1016/j.envpol.2017.05.023
- Tiwary, A., Williams, I. D., Pant, D. C. and Kishore, V. V. N. (2015). Assessment and mitigation of the environmental burdens to air from land applied food-based digestate, *Environmental Pollution*, 203, 62–270. doi: 10.1016/j.envpol.2015.02.001
- Tomlinson, S.J., Carnell, E.J., Tang, Y.S., Sutton, M.A. and Dragosits, U., 2017, Ammonia emissions from UK non-agricultural sources in 2016: contribution to the National Atmospheric Emission Inventory. Edinburgh, NERC/Centre for Ecology & Hydrology, 23pp.

## GLOBAL NITROUS OXIDE DATABASE FOR IMPROVED ANALYSIS AND EXTRAPOLATION

DORICH, C.D<sup>1</sup>., CONANT, R.T<sup>1</sup>., GRACE, P<sup>2</sup>., SNOW, V<sup>3</sup>., VOGELER, I<sup>4</sup>., VAN DER WEERDEN, T<sup>3</sup>., ALBANITO, F<sup>5</sup>.

<sup>1</sup> Natural Resource Ecology Lab, Colorado State University, USA; <sup>2</sup>Queensland University of Technology, Australia; <sup>3</sup>AgResearch, New Zealand; <sup>4</sup>Plant and Food Research, New Zealand; <sup>5</sup>Institute of Biological and Environmental Science, University of Aberdeen, UK

### INTRODUCTION

Nitrous oxide emissions are notoriously variable – through time, across space, and with management and environmental conditions. Time and budgetary constraints force compromises in N<sub>2</sub>O emission sampling extent, frequency, and duration with field measurements of N<sub>2</sub>O emissions typically carried out only during the growing season and at a roughly bi-weekly time scale. Given the episodic nature of N<sub>2</sub>O emissions, spotty measurements can easily result in unreliable N<sub>2</sub>O estimates, especially when field measurements are extrapolated to annual values (Reeves and Wang, 2015; Barton et al., 2015). Sampling and data analysis have therefore proven difficult and techniques used for gap filling missing data and extrapolating measurements have been largely inadequate. Further, previous analysis efforts primarily focus on examining a single site and research project being maintained by a research group, with methods not carrying over between sites. Proper extrapolation and gap filling techniques are needed in order to better estimate fluxes in lieu of missing measurement data. However, studies of ‘gap filling’ and timing of N<sub>2</sub>O emissions are limited in the literature (Mishurov and Kiely, 2011; Reeves and Wang, 2015; Barton et al., 2015). This makes N<sub>2</sub>O emissions an important research area as N<sub>2</sub>O is a potent greenhouse gas (GHG) with agriculture representing the largest source of N<sub>2</sub>O emissions. There is substantial interest in N<sub>2</sub>O reduction from agriculture as a part of the global climate change mitigation strategy (Paustian et al., 2016), yet methods for measuring or estimating N<sub>2</sub>O emissions remain highly uncertain. Intensification of crop production, at least in part through increased fertilizer inputs, is essential for feeding a growing and hungry planet. In order to address concerns around N<sub>2</sub>O emissions, improve methods and estimation techniques, and set up mitigation pathways and potential markets, we need a more comprehensive research analysis to better understand N<sub>2</sub>O emissions. We are creating the first global N<sub>2</sub>O database in collaboration with researchers from around the world in order to use advanced statistics to analyze data across sites and improve the research communities understanding of N<sub>2</sub>O.

### MATERIAL AND METHODS

Publically available data sets, like that found in Albanito et al (2017), will be combined with national level databases like GRACEnet to form the first global data set. The design and implementation procedures for this new, publically available database will be based on stakeholder feedback during a planning workshop held within the year. The database will be used for statistical analysis of auto chamber and flux tower data in order to develop gap-filling methods and to improve extrapolation techniques for making annual estimates of annual N<sub>2</sub>O emissions. Analysis will be conducted on a calibration data set and then validated against independent data. The N<sub>2</sub>O emission database will be housed on an interactive website created and hosted at Colorado State University. Using the global database we intend to pursue a variety of methods, including; gap filling, extrapolation, Bayesian, mixed models and more in order to fully utilize the available N<sub>2</sub>O data and develop a better understanding of emissions.

### RESULTS AND DISCUSSION

Given the current practice of extrapolating measurement data to an annual value using a simple average or linear interpolation between measurements, the accuracy of field measurements is questionable (Reeves and Wang, 2015). Comparing empirical N<sub>2</sub>O equation estimates to these field estimated annual N<sub>2</sub>O fluxes extrapolated from limited field data may therefore be fundamentally flawed. Sampling around expected hot moments can lead to a

more reliable estimate of N<sub>2</sub>O emissions if sampling and analysis is done properly (Reeves and Wang, 2015). If done improperly, using a simple average from field data or extrapolating from these emissions can potentially skew the result, either due to a high volume of sampling around peak emissions or the lack thereof. A global database will also allow for a thorough review of management practices and nitrogen inputs to further examine emission factors (EF) and our understanding of N<sub>2</sub>O emissions. Reeves and Wang (2015) examined one site in Australia with three years of auto chamber data, comparing continuous data to various simulated sampling campaigns. Their analysis examined sampling from a tri-weekly basis up to fortnightly, with other scenarios also 'chasing peaks' by sampling around large (>20 mm) rainfall events on top of the routine sampling. As shown in **Erreur ! Source du renvoi introuvable.1**, triweekly sampling resulted in the lowest deviation from field emissions. This comes as no surprise as it is the closest sampling structure to the timing of auto chamber sampling, and thus the most complete dataset. However, weekly measurements with biweekly or triweekly measurements around large rainfall events resulted in reliable results as well (Reeves and Wang, 2015).

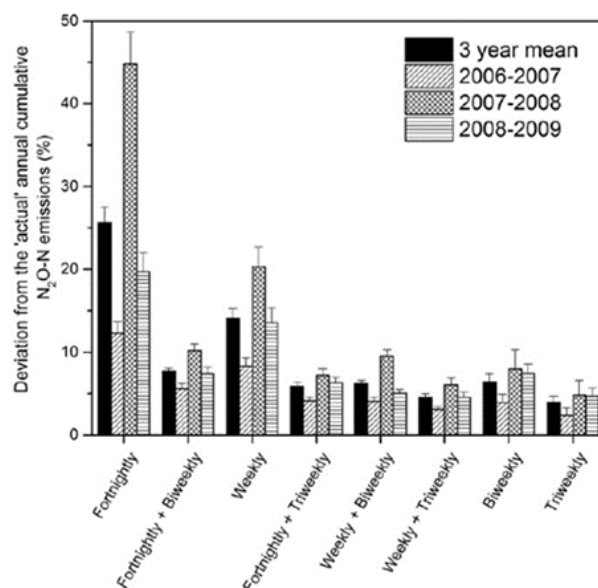

Figure 1. Static and auto chamber measured N<sub>2</sub>O emissions compared at various typical sampling regime protocols. Taken from Reeves and Wang, 2015, Figure 5

## CONCLUSION

This project will close the gap by examining global N<sub>2</sub>O sites to determine better techniques for gap filling data, improved extrapolation techniques, provide more accurate methods for estimating annual emissions, and allowing proper comparison of N<sub>2</sub>O methodologies to field emissions. We believe the database and resulting work will lead to a better understanding of N<sub>2</sub>O emissions, new pathways for future research, and improved methodologies and estimation techniques. If you are interested in participating in this exercise or providing data please contact us.

## REFERENCES

- Albanito, F., Lebender, U., Cornulier, T., Sapkota, T.B., Brentrup, F., Stirling, C., and Hillier, J., 2017. Direct nitrous oxide emissions from tropical and sub-tropical agricultural systems – a review and modelling of emission factors. *Nature, Scientific Reports*, 7:44235.
- Barton, L., Wolf, B., Rowlings, D., Scheer, C., Kiese, R., Grace, P., Stefanova, K., and Butterbach-Bahl, K., 2015. Sampling frequency affects estimates of annual nitrous oxide fluxes. *Nature Scientific Reports* 5:15912.

Session II: Regional studies - Highlighted posters

- Mishurov, M., and Kiely, G., 2011. Gap-filling techniques for the annual sums of nitrous oxide fluxes. *Agricultural and Forest Meteorology*, 151, 1763-1767.
- Paustian, K., Lehmann, J., Ogle, S., Reay, D., Robertson, G.P., and Smith, P., 2016. Climate-smart soils. *Nature Perspectives* 532, 49-57.
- Reeves, S., and Wang, W., 2015. Optimum sampling time and frequency for measuring N<sub>2</sub>O emissions from a rain-fed cereal cropping system.

## THE PROBLEM OF REGIONAL NUTRIENT IMBALANCES

BITTMAN, S.<sup>1</sup>. SHEPPARD, S.C. <sup>2</sup> POON, D.<sup>3</sup> HUNT D.E. <sup>1</sup>

<sup>1</sup> Agriculture and Agri-Food, Canada; <sup>2</sup> ECOMatters, Inc., Canada; <sup>3</sup> British Columbia Ministry of Agriculture, Canada;

### INTRODUCTION

Balancing nutrients on farms involves matching nutrient outputs with the least possible inputs, which for most farms is primarily fertilizer, feed, deposition, and in some cases biological nitrogen (N) fixation and manure from nearby livestock operations. On a national level, budgets must also account for the fate of nutrients that leave the farm. The contemporary problem is the increasing concentrations of nutrients in densely populated urban and peri-urban regions, the urban areas receiving nutrients as food and amenities, and the peri-urban areas typically as fertilizer and feedstuffs for intensive farming operations on expensive, limited and often very productive agricultural land. The peri-urban farmland is prized, and often protected by statutes, for providing fresh local food, economic activity, green space, and the sense of food security. But the contribution of intensive farming near cities to environmental sustainability is not clear in part because of its contribution to the influx of nutrients. Our study quantified the N budget and flows in a well delineated peri-urban region called Lower Fraser Valley (LFV) which includes the city of Vancouver and some of the most productive and expensive agricultural land in Canada. Our goal is to identify improvements in N cycling strategies.

### MATERIAL AND METHODS

The study area in south coastal British Columbia, Canada (1500 mm precipitation) is bounded by steep mountains, Pacific Ocean and the international border, and encompasses 2.6 million people along with 55,000 ha of expensive and intensively farmed land. The three dominant agricultural sectors are: dairy, occupying nearly half the land, horticultural (especially small fruits) on most of the rest, and a substantial, nearly landless poultry sector. The population, residing mainly in Metro Vancouver, is ethnically diverse and values its access to local, fresh food and supports the protected Agricultural Land Reserve. We estimated regional farm N influx from imported feeds, fertilizer and animals, and regional urban N influx from imported food, pet food, horse feed and fertilizer. We estimated regional efflux from farms as exported food and live animals, gaseous emissions (mainly ammonia, NH<sub>3</sub>) from manure and fertilizer, and losses into above ground and below ground waterways. For cities, regional efflux were from waste products (sewage, food and garden) that were combusted, discharged into waterways, sequestered in landfills and in soils (as compost) and exported from the region. There was also gaseous emission from composting and incinerating waste. We considered N influx and emissions from fuels to be outside our system boundaries, but wet deposition of reduced and oxidized N was included. Internal flows were also determined including consumption of local food, and re-use of manure, rendering products and municipal wastes (food, yard and sewage). Data were mainly from government statistics, local surveys, industry and government experts and published literature. We also referred to a few local research studies.

### RESULTS AND DISCUSSION

LFV farms imported about 26.9 kt N for food production mostly as feed (19.5 kt) and fertilizer (4.5 kt) (Table 1). Most farm output (6.7 kt N) was consumed in the LFV but 3.7 kt N was exported from the region. Hence, regional farmgate N efficiency was 39%, but this does not account for N losses in production of imported feed crops. N was lost from farms mainly as ammonia emissions (6.7 kt), and the calculated soil N surplus of 8.3 kt was assumed to be lost mostly by leaching due to high wintertime precipitation. This was somewhat greater than our estimate of total LFV residual soil N after crop harvest (5.7 kt N), which was based on a recent field study of farm soils (Sullivan and Poon, 2016). It is also consistent with our estimates of N drainage (5.2 kt) into the Fraser River which collects the ample surplus water from the majority of the farmland in the LFV (from Voss et al. 2014). In the urban

ecosystem, N influx (14.2 kt) was mostly as imported food (9.2 kt), atmospheric deposition (2.9 kt), and smaller amounts of various amenity products such as horse feed, pet food and fertilizer for lawns, etc. Most N was lost from urban ecosystem by discharge from waste water treatment plants (10.3 kt) and as emissions from composting (2.7 kt) and combustion of solid waste (1.0 kt). Some N was used on urban soils or sequestered in landfills (3.7 kt) and a small amount exported mostly to low production rangeland outside the region (0.12 kt). Whereas most N was lost by emissions and leaching, a previous LFV study showed that P was lost by runoff and discharge, but also accumulated in rural and urban soils (Bittman et al. 2017).

The reactive N (all non-N<sub>2</sub> species) lost from the LFV (29 kt) has a commercial fertilizer value of almost \$30 million. This reactive N may have additional environmental and human health costs. Some N was locally recycled (manure, rendering waste and atmospheric deposition) but very little of the 30 kt of imported N was returned to the sources of the imported feeds and foods. The recycling programs such as waste to energy (combustion), composting of solid waste and poultry litter, and biogas production are repurposing C but not N or P.

*Table 1. Nitrogen budget (kt N/year) for Lower Fraser Valley (LFV) showing regional influx and efflux for the agricultural and urban ecosystems. Fuel combustion was not included except for deposition.*

		Influx	Efflux	
Agriculture	Fertilizer	4.52	Food and animal export	3.73
	Feedstuffs	19.5	Fish farms	1.52
	Live animals	1.10	Emissions (NH <sub>3</sub> )	6.73
	Deposition (NH <sub>4</sub> and NO <sub>x</sub> )	1.81	Surplus (leaching and denitrification)	8.28
			<i>Food to urban ecosystem</i>	<i>6.71*</i>
	<b>Total</b>	<b>26.91</b>	<b>20.26</b>	
Urban	Imported food	9.21	Effluent from WWTP**	10.33
	Fertilizer	0.89	Landfill	3.70
	Pet food	0.31	Incineration	0.96
	Horse feed	0.92	Emissions (NH <sub>3</sub> )	2.73
	Deposition (NH <sub>4</sub> and NO <sub>x</sub> )	2.88	Export	0.12
	<b>Total</b>	<b>14.21</b>	<b>17.84</b>	
<b>LFV</b>	<b>Total</b>	<b>41.14</b>	<b>38.1</b>	

\*internal flow from agriculture to urban, not included in efflux. \*\* WWTP Waste Water Treatment Plant

## CONCLUSION

Waste recycling programs inadvertently focus on C and fail to improve N and P cycling, so much of imported N and P is wasted as gases and solutes which are harmful to the environment. There are end-of-pipe technologies for extracting nutrients that can be recycled to source farms, but these are expensive. Alternatively, restricting fertilizer imports may improve nutrient efficiencies by encouraging adoption of established and fledgling technologies. In cities, there is already a tendency to consume less animal products, and technology and education can be used to safely reduce waste.

## REFERENCES

- Bittman, S., Sheppard, S.C., Poon D. and Hunt, D.E. 2017. Phosphorus flows in a peri urban region with intensive food production: a case study. *J. Env. Manag.* 187, 286-297
- Sullivan, C.S., Poon, D., 2016. Fraser Valley Soil Nutrient Survey 2012. [https://www2.gov.bc.ca/assets/.../soil-nutrients/.../fvsns2012\\_report-aug2016.pdf](https://www2.gov.bc.ca/assets/.../soil-nutrients/.../fvsns2012_report-aug2016.pdf)
- Voss, B.M., Peucker-Ehrenbrink, B. et al. 2014. Tracing river chemistry in space and time: Dissolved inorganic constituents of the Fraser River, Canada. *Geochi. Cosmochim. Acta* 124, 283–308.

# 20<sup>th</sup> Nitrogen Workshop

## Coupling C-N-P-S cycles

June 25-27, 2018

Le Couvent des Jacobins, Rennes – France

### **Session II: Regional studies - Posters**



## **NITROGEN USE EFFECTIVENESS OF TERRITORIAL AGRO-FOOD SYSTEMS: A LONG TERM PERSPECTIVE AT THE FRENCH REGIONAL SCALE**

BILLEN, G., LE NOE, J., GARNIER, J.

UMR Metis, Sorbonne-Université/CNRS, France

### **INTRODUCTION**

While the definition of nitrogen use efficiency (NUE) of farming systems (ratio of outputs to inputs) might seem simple and straightforward, it is in fact very controversial because of the difficulties in defining the limits of the system, in estimating the inputs and in defining what to consider as output (see e.g. Godinot et al. 2014; Garnett et al., 2015). Here we address the issue of N effectiveness at the territorial scale through the analysis of the relationship between yield and the degree of N-intensification, defined as the total input of reactive N to the system. We want to analyze, over a long term historical perspective, how the design of nitrogen flows through territorial agro-food systems have evolved within their particular pedo-climatic and socio-technical contexts. In short, we want to link the structure of the regional agro-food systems to their fluxes of N inputs, outputs and losses, and to identify major transitions, with respect to nitrogen use effectiveness during the last centuries.

### **MATERIAL AND METHODS**

The estimation of N inputs and outputs of regional cropping and production systems at the scale of 33 regions and 22 dates from 1852 to 2014 is based on the data assembled according to the GRAFS approach (Generalized Representation of Agro-Food Systems) by Le Noë et al (subm). Our analysis first deals with cropping systems, for which total input consists of manure, symbiotic fixation, synthetic fertilizers and atmospheric deposition to the regional arable area, and output is the harvested and grazed crops. Then we consider agricultural production systems, for which input consists, not only of inputs to cropland and grassland, but also of imported forage and feed, while output is net crop production (i.e. production not locally used for feeding livestock) plus edible animal production.

### **RESULTS AND DISCUSSION**

#### **Cropping systems**

A robust, one parameter ( $Y_{max}$ ) hyperbolic relationship links output from cropping systems ( $Y$ ) and total soil N input ( $F$ ), averaged over a whole crop rotation cycle (Lassaletta et al., 2014). The distance of the relationship to the 1:1 curve is the surplus, an indicator of N losses. Within the same technical-pedo-climatic context, the same relationship holds whatever the rotation is based on organic or mineral fertilization (Anglade et al, 2015) (Fig.1a). This relationship also describes the trajectory of the yield response to long term N-intensification of particular regions (Fig. 1b), with however a distinct shift in  $Y_{max}$  occurring after the 1980's, reflecting either better (e.g., Picardy, Burgundy) or worse (e.g. Brittany) N-effectiveness.

#### **Production systems including livestock farming**

The preceding relationship for cropland can be generalized to the entire territorial production system including livestock, by taking into account several other parameters related to livestock feed conversion efficiency, and permanent grassland role in livestock nutrition. The predicted relationship between total system production and its degree of N-intensification levels off at much lower total yield when the part of animal products increases in the regional production. This theoretical framework of analysis allows modeling and understanding the pattern of the trajectory followed in terms of production of harvested food and N-intensification since the mid-19<sup>th</sup> century by the different French regions.

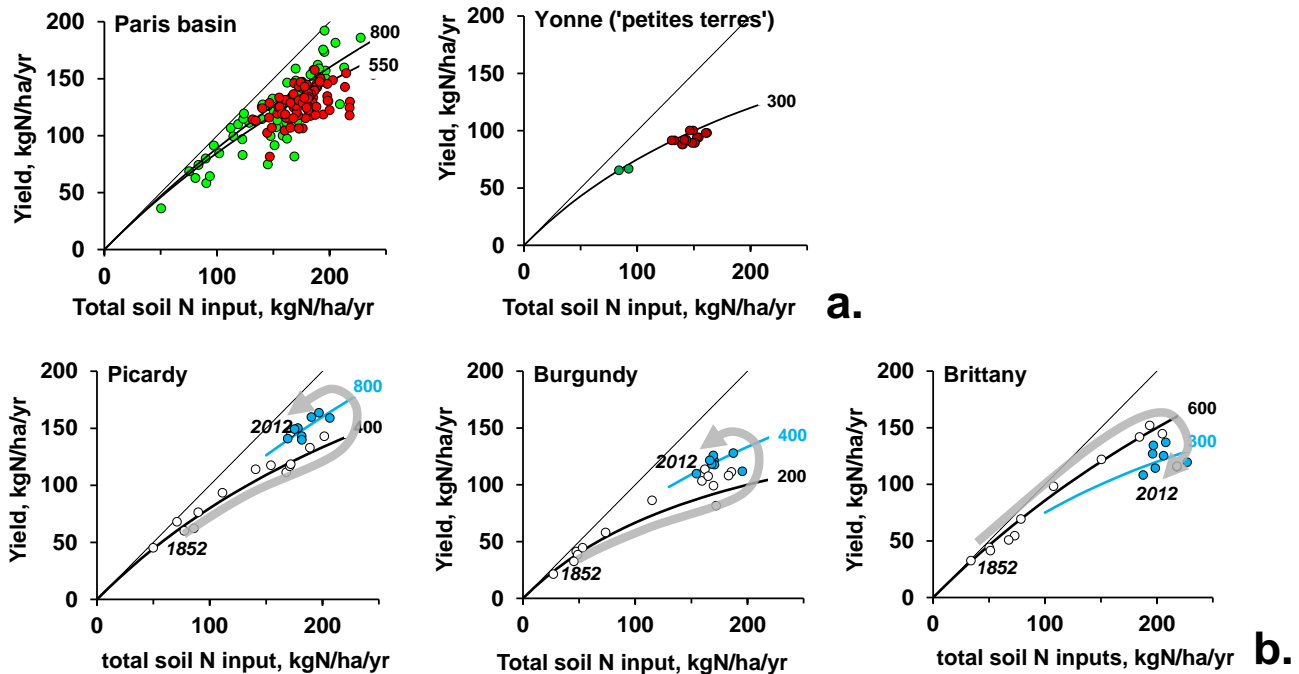

Figure 1.a. Currently observed relationship between harvested crop from arable land and total N soil inputs for conventional (red) and organic (green) rotations documented through surveys in the central Paris basin and in the Plateau “petites terres” in Burgundy (Anglade et al., 2015). b. Long term trajectories in terms of cropland yield and N-intensification in Picardy, Burgundy and Brittany, based on territorial statistical data (Le Noë et al, 2018) (blue points for post 1995).

## CONCLUSION

Studying the relationship between production (in terms of embedded protein) and nitrogen input for either cropping or whole production systems at the territorial scale allows to avoid several drawbacks of a simple NUE approach. NUE cannot be considered as an intrinsic property of a single cropping or production system: it primarily depends on the degree of N-intensification and decreases with increasing N inputs. Thus, N-intensification, more than agronomical techniques as reflected by  $Y_{max}$  changes, is the primary factor explaining the long term trends of N-losses from cropping systems. Similarly for territorial production systems involving livestock, N-intensification, as well as the share of animal products in the total agricultural production and the share of grass in animal nutrition, are the most important factors controlling total yield and N losses. The trends of specialization and intensification observed in French regional agricultural systems since the mid-19<sup>th</sup> century have strong and sometimes counteracting consequences in terms of N effectiveness, that can only be disentangled using the analytical framework we are proposing here.

## REFERENCES

- Anglade J, Billen G, Makridis T, Garnier J, Puech T et Tittel C., 2015. Nitrogen soil surface balance of organic vs conventional cash crop farming in the Seine watershed. *Agricultural Systems* 139:82-92.
- Garnett T., Röös E., Little D., 2015. Lean, green, mean, obscene...? What is efficiency? And is it sustainable? Food Climate Research Network. Environmental Change Institute. University of Oxford. UK.
- Godinot O., Carof M., Vertès F., Leterme P., 2014. SyNE: An improved indicator to assess nitrogen efficiency of farming systems. *Agricultural Systems*. 127:41-52
- Lassaletta L., Billen G., Grizzetti B., Anglade J., Garnier J., 2014. 50 year trends in nitrogen use efficiency of world cropping systems: the relationship between yield and nitrogen input to cropland. *Environ. Res. Lett.* 9. DOI:10.1088/1748-9326/9/10/105011
- Le Noë J., Billen, G., Esculier, F., Garnier, J., 2018. Long term socio-ecological trajectories of agro-food systems revealed by N and P flows: the case of French regions from 1852 to 2014. *Agr. Ecosyst. Env.* (submitted).

## **REGIONAL N AND P CYCLING IN AGRO-FOOD SYSTEMS: LONG TERM HISTORICAL AND FUTURE TRAJECTORIES IN FRANCE**

LE NOË, J.<sup>1</sup>, BILLEN, G.<sup>1</sup>, GARNIER, J.<sup>1</sup>

<sup>1</sup>Sorbonne Université, UPMC, CNRS, EPHE, UMR 7619 METIS, 4 place Jussieu, Paris, France

### **INTRODUCTION**

Modern agricultural practices are responsible for a considerable disturbance of the N and P cycles. To engage agriculture on more sustainable paths, lessons learnt from the history are needed, because current agro-ecosystems result from historical process which may vary widely from one place to another. In this context, we first analyzed the trajectories of agricultural systems in French regions across the 1850-2014 period. Then we explored two contrasted scenarios for French agriculture in the future, either pursuing or reverting the past observed trajectories toward specialization and opening.

### **MATERIAL AND METHODS**

We used the Generalized Representation of Agro-Food System (GRAFS) approach, a model which provides a biogeochemical description of agro-food system in a delimited area. It traces the N and P flows between four main compartments: cropland, grassland, livestock biomass, the local population. The GRAFS provides some key indicators for analyzing agro-food systems from both the environmental and agronomic performances such as N surplus and P balance over grassland and arable land. For retrospective analysis, this approach was used at the scale of the 33 French regions as defined by Le Noë et al. (2016) for 22 dates between 1852 and 2014. For prospective analysis, we used the GRAFS approach to explore possible scenarios for 2050, accounting for official demographic forecasts and on hypothesis regarding cropping techniques, their connection with livestock and the composition of human diet.

### **RESULTS AND DISCUSSION**

#### **Typology of the different kinds of agro-food systems**

To systematize the analysis of our results and to obtain an objective assessment of the trajectories of the 33 French regions, we have chosen to aggregate regions according to similarities in their production pattern. For this purpose, we have defined biogeochemical criteria to check the level of interaction between arable land, livestock and grassland, based on nutrient fluxes or flux ratios and identified five different types of agro-food systems in French regions: (i) "specialized arable crop"; (ii) "Intensive livestock farming"; (iii) "Extensive integrated crop and livestock farming"; (iv) "Intensive integrated crop and livestock farming" and (v) "disconnected Intensive crop and extensive livestock farming".

#### **Historical trajectories**

In the mid-19<sup>th</sup> century, integrated crop and livestock farming systems were the rule everywhere in France (Figure 1) and manure recycling was the main source of agricultural land fertilization. However, at the beginning of the 20<sup>th</sup> century, the sustainability of this farming system began to be jeopardized by the mining of soil nutrient stocks, especially P. Over the course of the 20<sup>th</sup> century, this situation shifted towards more contrasted production patterns. This became particularly true after the Second World War: modernization of agriculture contributed to the emergence of specialized cereal cropping systems in the most fertile plains of the North of France (Figure 1), exporting a large fraction of their cereal production. The significant rupture after 1946, which accentuated the openness of regional agro-food system, was promoted by the increased use of mineral fertilizers and the subsequent disconnection of vegetal and animal production in regions on a path to specialization. Overall, regions of intensive cropping revealed the highest degree of openness through crop exportation, while the region of

intensive livestock farming was characterized by a growing reliance on feed import and over-fertilization of arable land through manure inputs. However, all regions intensified their production during the second half of the 20<sup>th</sup> century by increasing rates of mineral fertilizer inputs. As a result, increasing arable yields, N surpluses and P balances rose too (Figure 1). The rise of fertilizer prices together with the implementation of agro-environmental measures over the last two decades resulted in the lowering of N surpluses and P balances, which were even negative in regions specialized in crop production (Figure 1). However, as long as the agro-food system remains specialized, possible changes through improved fertilization will be limited by the inefficiency of nutrient recycling at the regional level.

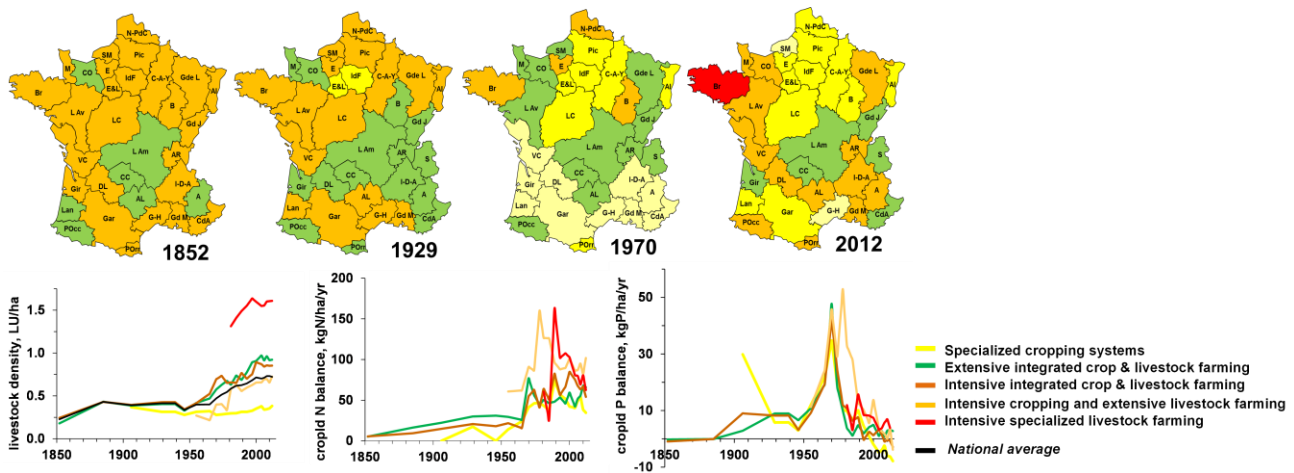

Figure 1. Evolution of regional specialization in France and of livestock density, N surplus (kg N.ha<sup>-1</sup>.yr<sup>-1</sup>) and P balances (kgP.ha<sup>-1</sup>.yr<sup>-1</sup>) over arable land from 1852 to now

### Possible future scenarios

Overall, it was notable that greater specialization went parallel with decreasing environmental performances, while the increasing demand for animal proteins appeared as a driver of an increased dependency on feed import for livestock production. Therefore, the trend scenario assuming the pursuit of agriculture specialization, a human diet rich in animal products and an intensive use of chemical fertilization would exacerbate the poor recycling of nutrient, the robbing of soil P in feed exporting country and the losses of N and P to hydrosystems. By contrast, the scenario assuming reconnection of crop and livestock production and a better use of soil P reserves would enable to progressively eliminate the use of chemical fertilizer. Switching back to a Mediterranean diet would facilitate to decrease the dependency of livestock upon feed importation and would instead promote C storage through extension of grassland surfaces, a sink of C.

### CONCLUSION

This study demonstrates the value of adopting a long-term perspective to articulate a vision of how environmental and agronomic performances are related to production pattern changes. Based on our results, we argued that sustainable agriculture at the regional scale could only be achieved through a complete overhaul of the structure of agricultural systems and a shift toward less animal protein in the human diet.

### REFERENCES

Le Noë J., Billen G., Lassaletta L., Silvestre M., Garnier J., 2016. La place du transport de denrées agricoles dans le cycle biogéochimique de l'azote en France: un aspect de la spécialisation des territoires Cah. Agric. 25, 15004.

## NITROGEN AND CARBON FOOTPRINTS OF CONTRASTING DAIRY FARM SYSTEMS IN CHINA AND NEW ZEALAND

LEDGARD, S.F.<sup>1</sup>, WEI, S.<sup>2</sup>, WANG, X.<sup>3</sup>, FALCONER, S.<sup>1</sup>, ZHANG, N.<sup>2</sup>, ZHANG, X.<sup>2</sup>, MA, L.<sup>2</sup>,

<sup>1</sup> AgResearch, New Zealand; <sup>2</sup> The Chinese Academy of Sciences, China; <sup>3</sup> Northwest Agriculture and Forestry University, China

### INTRODUCTION

Dairy farm systems are important for global food protein production. However, they can contribute significantly to environmental impacts, including through nitrogen (N) emissions to water and the atmosphere, as well as to global greenhouse gas (GHG) emissions. There have been numerous studies of the carbon (C) footprint (i.e. total GHG emissions) of milk, but few studies have provided detailed results of the total reactive N emissions (N footprint; e.g. Leip et al. 2014) of different dairy production systems to understand the main drivers and reduction opportunities for the N footprint of milk. Such studies need to account for all reactive N emissions and this is best achieved using a life cycle assessment (LCA) approach to ensure that all N emissions are accounted for. The aim of this study was to evaluate the N and C footprints of milk production (using LCA) in contrasting systems in China (full housed cow systems) and New Zealand (NZ; year-round outdoor grazing systems), and the effects of intensification achieved through increased production per cow by increased level of feeding of crops.

### MATERIAL AND METHODS

The three Chinese farms, categorized as low, medium and high (Table 1) according to milk production per cow, were based on averages from survey data for farms in the Shaanxi, Hebei and Beijing regions, respectively. All cows and replacement animals were housed year-round with all feeds produced off-farm. For the NZ farms, the three farm systems from the Waikato region were summarized from farm survey data. All NZ farms relied largely on grazing of perennial ryegrass/white clover pastures and were classified into low, medium and high according to the level of brought-in supplementary feeds (average of 0.3, 0.8 and 1.7 t dry matter/cow, respectively).

Crop yields and inputs for production of brought-in feeds in China and NZ were based on published data. For NZ, the total feed intake from grazed pasture was calculated using a national energy requirement model applying animal live-weight and production data. The amount of N excreted was calculated by subtracting the output of N (in milk and live-weight sold) from the total feed N intake. In China, manure collected from housing was assumed to be subjected to passive composting for up to 3 months, after which it was transported and applied to cropland, except for 20% which was discharged to water based on national data. In NZ, manure collected from milking sheds was assumed to be sprayed onto the pasture. Emissions of N and GHGs were calculated using a combination of default IPCC emission factors and the NUFER model (Ma et al. 2010) for Chinese farm systems, while for NZ farm systems it was based on national inventory methods and the OVERSEER<sup>®</sup> model (Ledgard et al. 2004). LCA models were used to calculate emissions from the production and use of inputs (e.g. fertilizers, fuel, electricity, off-farm feeds), including NO<sub>x</sub> from energy sources.

### RESULTS AND DISCUSSION

Most N loss occurred as ammonia in all systems, with ammonia-N per kg fat- and protein-corrected milk (FPCM) decreasing from low to high farm systems in both countries. For NZ, this can be attributed to the low N concentration in brought-in feeds compared to that in pasture, resulting in less surplus N per kg feed-N consumed and a lower proportion excreted in urine-N which is the main source of the ammonia emissions. However, in China there was little difference in average dietary N concentration and the decrease in ammonia-N/kg FPCM was associated with higher milk production per cow (with lower associated feed use for animal maintenance) and with lower manure emissions. For China, there was little difference between farm systems in other forms of N emissions, so that overall the high farm system had a 47% lower N footprint than the low farm system. The

corresponding difference for NZ was a 13% lower N footprint in the high feed-input farm system. Manure and fertilizers were dominant contributors to total N emissions in China, whereas in NZ the total N emissions were dominated by urine from grazing animals. In both countries, there was a large variation in the N emissions per kg dry matter from the production of feeds, illustrating that there is potential to reduce the N footprint of milk by selecting low N-emission feeds. The effects of different feed options were evaluated using scenario analysis.

Methane (largely from animal feed digestion) and N<sub>2</sub>O emissions (mainly from manure and fertilizer use) per kg FPCM decreased from low to high farms in both countries. In NZ, these decreases were offset by increased CO<sub>2</sub> emissions associated with the production and feeding of crops in the high feed-input farm system. In contrast, the CO<sub>2</sub> emissions were a significant component of the total carbon footprint in China, but all GHGs decreased between low and high systems, with greater system efficiency through higher milk production per cow.

*Table 1. Comparison of farm systems in China and New Zealand varying in level of milk production per cow based on increased use of brought-in crop feeds. Data was derived from averages of survey farms, while nitrogen and carbon emissions were estimated using country-specific models, including life cycle assessment for background emissions.*

	China			New Zealand		
	Low	Medium	High	Low	Medium	High
Milk per cow (t FPCM/cow)	5.8	7.3	8.5	4.6	5.0	6.1
Nitrogen footprint (g N/kg FPCM):						
Nitrate to water	3.66	2.97	3.29	2.52	2.55	2.67
Ammonia	11.12	8.31	4.74	3.81	3.51	2.77
Nitrous oxide (N <sub>2</sub> O)	0.45	0.38	0.37	0.26	0.24	0.19
NOx	0.19	0.21	0.26	0.12	0.14	0.18
TOTAL	15.43	11.87	8.67	6.71	6.44	5.81
Carbon footprint (kg CO <sub>2</sub> -eq/kg FPCM):						
Methane	0.80	0.60	0.53	0.54	0.51	0.44
Nitrous oxide	0.27	0.22	0.23	0.12	0.11	0.09
Carbon dioxide (CO <sub>2</sub> )	0.28	0.20	0.22	0.08	0.09	0.22
TOTAL	1.35	1.02	0.97	0.74	0.71	0.75

## CONCLUSION

In housed dairy systems in China, the N and C footprints of milk decreased with increased system intensity through greater use of quality feeds and increased milk production per cow. Similarly, in the grazed pasture systems of NZ, the N footprint of milk decreased with increased milk production per cow through brought-in crop feeds. However, there was no change in the C footprint of milk in NZ due to the greater CO<sub>2</sub> emissions from the production and feeding of crops compared to that from the grazing systems with low GHG emissions.

## REFERENCES

- Ledgard S.F., Wheeler D.M., de Klein C.A.M., Monaghan R.M., Johns K., 2004. Development of the OVERSEER<sup>®</sup> nutrient budget model to examine implications of pastoral management practices on nitrogen flows and losses, in: Hatch, D.J., Chadwick, D.R., Jarvis, S.C., Roker, J.A. (Eds.), *Controlling Nitrogen Flows and Losses*. Wageningen Academic Publishers, The Netherlands. pp. 571-572.
- Leip A., Weiss F., Lesschen J.P., Westhoek, H., 2014. The nitrogen footprint of food products in the European Union. *J. Agric. Sci.* 152, S20-33.
- Ma L., Ma W.Q., Velthof G.L., Wang F.H., Qin W., Zhang F.S., Oenema O., 2010. Modeling nutrient flows in the food chain of China. *J. Env. Qual.*, 39, 1279–1289.

## AN OVERVIEW OF NITROGEN FERTILISATION PRACTICES IN FRANCE

DUFOSSE, K.<sup>1</sup>, RAMANANTENASOA M. M. J.<sup>1</sup>, MIGNOLET C.<sup>2</sup>, TROCHARD R.<sup>3</sup>, GILLIOT, J.-M.<sup>1</sup>, BESSAGNET, B.<sup>4</sup>,  
GENERMONT, S.<sup>1</sup>

<sup>1</sup> UMR EcoSys, INRA; AgroParisTech, Université Paris-Saclay, France; <sup>2</sup>UR SAD, INRA, France; <sup>3</sup>ARVALIS, France; <sup>4</sup> INERIS, France

### INTRODUCTION

Nitrogen (N) fertilisation is a key element to ensure crop yield and thus food security. Amongst numerous other factors, the amount of N applied in fields is driven by the type of culture and soil, as well as by economics and temporal factors. However, this fertilisation is also a source of multiple environmental impacts (soil acidification, water eutrophication, global warming and air quality depletion). In order to mitigate the impacts, politics are developed at large scale, usually national, whereas the impacts happen at a finer scale. Besides, the range of products available for farmers is always wider. Detailed information on the N fertilisation is thus crucial to develop mathematical models to evaluate yields and/or environmental impacts. This study is aiming at presenting an overview of the organic and mineral N fertilisation in France for the crop years 2005-06 and 2010-11. A focus is carried on the latter as the available information is more precise.

### MATERIAL AND METHODS

N fertilisation management data are issued from national survey of cultural practices for arable crops and grassland, conducted by the Department of Statistics and Forecasting of the French Ministry of Agriculture during the crop years 2005-2006 and 2010-2011, for 13 main crops and 21 regions (NUTS2) (AGRESTE, 2014). From this survey, statistical calculations were carried out following the methodology of Mignolet et al. (2007) to aggregate representative cultural practices at regional scale, including amount of organic and mineral fertilizer applied and distribution of these applications (fragmentation and period of application, types of products), as described in Générumont et al. (2015).

Mineral products were aggregated into the three main categories used in France: urea, nitrogen solution and ammonium nitrate. Organic fertilisation, described within 22 different categories in the survey, was aggregated into 8 main categories after a literature review and based on their origin and their chemical (pH, total and mineral N content) and physical (density, dry matter content and state) properties. The aggregated forms of organic fertilisers comprise 3 farmyard manures (FYM), 2 slurries, composts, industrial effluent and sludge.

### RESULTS AND DISCUSSION

The first sequence of results present the distribution of different forms of mineral (Figure 1) N fertilization per region in France for the crop year 2010-2011. The average repartition of mineral forms in France in 2010-2011 demonstrates a preference on ammonium nitrate (59% of N applied) over nitrogen solution (30%) and urea (11%). Major differences are observed between northern and southern parts as the share of ammonium nitrate is dominant in Southern France (Provence-Alpes-Côte-d'Azur and Limousin, over 85%) but nitrogen solution seems to be preferred in most of Northern regions (77% in Champagne-Ardenne). Urea, the greater NH<sub>3</sub> emission source amongst mineral N fertilizers, presents an unequal distribution over the country. Indeed, it shows large share of N applied in Aquitaine (48%) and Alsace (39%), but it is nearly not applied in Normandy and Picardie (less than 1%).

Similar outputs were produced for organic N fertilization. They express a large preference for bovine FYM application in France. However, the spatial distribution of organic of these organic products demonstrates huge discrepancies between regions (results not shown).

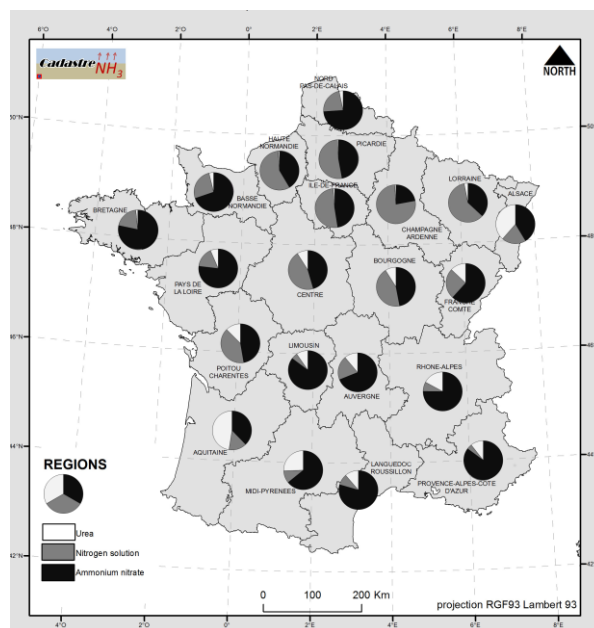

Figure 1. Distribution of the 3 main forms of mineral N fertilisation (urea in white, nitrogen solution in grey and ammonium nitrate in black) per region (%), average of AGRESTE survey (2014) on the 2010-11 crop year.

Crop average mineral and organic N fertilization were also estimated at regional scale. Evolution of amounts of applied product was also evaluated between the crop years 2005-2006 and 2010-2011. Type and amounts of applied products was estimated per crop type. These data can be used for national scale modelling such as NH<sub>3</sub> emissions through the CADASTRE\_NH3 tool also presented in this workshop.

## CONCLUSION

Regional scale is the minimum scale to evaluate N fertilization data as discrepancies between regions are linked with local context, either economic (e.g. product locally produced) or pedoclimatic. Finer distribution of these different forms of N fertilization will help to implement local or regional incentive. The latter can thus target specific regions, crops or products to minimize the environmental impacts.

**Acknowledgements:** This work was supported by a public grant overseen by the French National Research Agency (ANR) as part of the « Investissements d’avenir » program (reference: ANR-10-EQPX-17 – Centre d’accès sécurisé aux données – CASD). It was conducted within the CADASTRE\_NH3 (Spatial and temporal high-resolution inventory of ammonia emissions from agricultural soils over France at regional and national scales) project, supported by ADEME the French Agency for Energy and Environment, and the PolQA project (Mitigation policies to improve air quality through agricultural practices, agreement n°1662C0023), supported by the French PRIMEQUAL program (Programme de recherche interorganisme pour une meilleure qualité de l’air à l’échelle locale) and by the French Ministry for an Ecological and Solidary Transition.

## REFERENCES

- AGRESTE, 2014. Enquête Pratiques culturales 2011. In “Agreste Les Dossiers”, n°21- July 2014, pp.70.
- Génermont S., Gilliot, J. M., Ramanantenasoa, J., et al., 2015. Cadastre-NH3: Réalisation de cadastres dynamiques des émissions d’ammoniac liées à la fertilisation azotée aux échelles régionales et nationales - Rapport de fin de contrat, Convention INRA-ADEME n° 1081C0031, pp 107.
- Mignolet, C., Schott, C., and Benoit, M., 2007. Spatial dynamics of farming practices in the Seine basin: methods for agronomic approaches on a regional scale. *Sci Total Environ* 375, 13-32.  
DOI:10.1016/j.scitotenv.2006.12.004



## LARGE SCALE MODELLING OF NITRATE LEACHING FROM ARABLE LAND IN GERMANY

KLEMENT, L.<sup>1</sup>, BACH, M.<sup>1</sup>, BREUER, L.<sup>1</sup>, NENDEL, C.<sup>2</sup>, KERSEBAUM, K.-C.<sup>2</sup>, STELLA, T.<sup>2</sup>, BERG-MOHNICKE, M.<sup>2</sup>

<sup>1</sup> Institute of Landscape Ecology and Resources Management (ILR), Justus Liebig University Gießen, Germany; <sup>2</sup> Institute of Landscape Systems Analysis, ZALF, Leibniz-Centre for Agricultural Landscape Research, Muencheberg, Germany;

### INTRODUCTION

In Germany, around 26.3% of groundwater bodies are in a poor chemical state due to contamination with nitrate, according to the latest inventory of the EU Water Framework Directive (BMUB, 2014). For the past decades, Germany failed to impose effective measure to lower the nitrate groundwater concentration below 50 mg l<sup>-1</sup> throughout the country. This also means that Germany is not in compliance with the EU Nitrate Directive, leading the European Commission to file a lawsuit against Germany in late October 2016. Nitrate contamination of groundwater is suspected to increase the cost of drinking water purification for Germany's population by up to 45% (UBA, 2017) and thus is also regularly discussed in the German Press. The agricultural sector has been determined to be the main source of this nitrate contamination. Research on mitigating this contamination has mainly focused only on lowering the nitrogen surplus. However, regional geological and climatic heterogeneity has to be taken into account in order to assess the vulnerability of regions to nitrogen losses.

This study therefore focuses on modeling the nitrate leaching below the root zone (depth of 2 m) using a dynamic, process-based simulation model MONICA - Model of Nitrogen and Carbon dynamics in Agro-ecosystems (Nendel et al., 2011).

### MATERIAL AND METHODS

Nitrate leaching below 2 m soil depth was simulated for a 30 year period (1983 – 2012) using the model MONICA throughout the country. MONICA is a one dimensional model that represents a 1 m<sup>2</sup> pedon and simulates crop production as well as transport processes in the soil. It was successfully used in various local and regional scale modelling endeavors and fared well in comparative studies. Prior to this study however, modelling on larger or national scale had not been carried out using MONICA yet.

In order to model on the national scale, Germany was grouped into 44 pedo-climatic-regions adapted from the work of Roßberg et al. (2007), based on similar soil and climate conditions. One weather station was picked for each pedo-climatic-region. For the soils, 8 representative soil types are taken from the soil map BUEK1000 (BGR, 2007) to be implemented in the model. Each pedo-climatic-region was simulated with all 8 soil types and a number of realistic crop rotations derived from a total of 9 crops and fertilizing strategies differing in total amount and composition of organic and mineral fertilizations. Crop parameters were calibrated using phenology data for Germany provided by Germany's National Meteorological Service (DWD) in order to improve model fit. A factorial analysis was carried out to allow for greater insight on which input data was additionally needed to describe regional differences.

### RESULTS AND DISCUSSION

Preliminary model results with winter wheat showed that average nitrate leaching range from below 10 kg N ha<sup>-1</sup> up to 80 kg N ha<sup>-1</sup> per year. The highest nitrogen leaching was simulated for northern Germany where more intensive agriculture focused on livestock farming is located. The resulting NO<sub>3</sub> concentrations in leachate range from lower than 25 mg NO<sub>3</sub> l<sup>-1</sup> in high altitude regions up to 225 mg NO<sub>3</sub> l<sup>-1</sup> in regions with intensive agriculture and low recharge rates in the eastern parts of Germany. Further results using trinomial crop rotations will be presented and discussed at the workshop.

Phenological calibration has been a key element to improving the fit of modeled crop growth and to ensure that the model applies appropriate nitrogen uptake by the plant, enabling us to model nitrogen dynamics using MONICA. Due to the factorial analysis we were able to further improve the level of detail in our input data, resulting in a better fit of the model, especially in higher altitudes.

#### Conclusion

The study, which is unprecedented in this scale for Germany, showed promising results and could potentially be used by political decision makers to develop appropriate mitigation measures and identify regions that are most vulnerable to nitrate groundwater contamination.

In a large scale set up, it is important to acquire knowledge on what parameters are necessary to describe all regional differences that are important to crop growth and nitrate leaching. Even when a model successfully reflects field experiments and local scale settings, further adaptations and input data are needed when used for a large area with a high spatial variability.

Future work will focus on increasing the spatial resolution and to use the results of this study with a second model that routes the fluxes further into the saturated zone and the groundwater layers.

**Acknowledgements:** This study was funded by the German Environment Agency (UBA), Project No. 3715222200

#### REFERENCES

- BGR, 2007. Bodenarten der Böden Deutschlands - Bericht über länderübergreifende Auswertungen von Punktinformationen im FISBo. BGR, Hannover.
- BMUB, 2014. Wasserwirtschaft in Deutschland – Teil 2: Gewässerqualität. Bundesministerium für Umwelt, Naturschutz und Reaktorsicherheit (BMUB), Bonn.
- Nendel C., Berg M., Kersebaum K.C., Mirschel W., Specka X., Wegehenkel M., Wenkel K.O., Wieland R., 2011. The MONICA model: Testing predictability for crop growth, soil moisture and nitrogen dynamics. *Ecol. Model.* 222 (9), 1614–1625.
- Roßberg D., Miche V., Graf R., Neukampf R., 2007. Definition von Boden-Klima-Räumen für die Bundesrepublik Deutschland. *J. Kulturpflanzen* 59(7), 155-161.
- UBA, 2017. Quantifizierung der landwirtschaftlich verursachten Kosten zur Sicherung der Trinkwasserbereitstellung. Umweltbundesamt (UBA), Dessau-Roßlau.

## REGULATION OF ORGANIC NITROGEN IN FRANCE

LOYON, L.<sup>1</sup>

<sup>1</sup> IRSTEA, France;

### INTRODUCTION

Organic nitrogen ( $N_{org}$ ) spread annually in France is around 730 kt, of which 90% is of animal origin (Agreste, 2014). Cattle, pigs and poultry (19.5 million cattle, 13.9 million pigs and 222 million poultry in 2010) excrete annually 1.7 million tons of  $N_{org}$  that are mostly stored and spread on farmland. The treatment of  $N_{org}$  is still not widespread (Loyon, 2016). The intensive production of nitrogen in some production areas (Brittany for example) generates a surplus of organic and mineral nitrogen, estimated in 2013 at 902 000 tons (MEDDE, 2013a) involving high levels of nitrate in the water. Moreover, this production of organic animal nitrogen contributes 64% of national emissions of  $NH_3$  (679 kt in 2015) and 4.5% of  $N_2O$  emissions (137 kt of  $N_2O$ , excluding UTCF) (Citepa, 2017). This nitrogen pollution is controlled by regulatory measures on livestock farming and is the subject of public incentive policies targeted mainly for water quality and more recently for air quality and climate change. This paper aims to summarize the main measures currently in use.

### RESULTS AND DISCUSSION

#### Regulatory measures.

Depending on the number of animals, the farm is subjected to the Departmental Sanitary Regulations (RSD, Public Health Code) or to the legislation of Installations Classified for the Protection of the Environment (ICPE, Code of the Environment). National technical requirements defined in ministerial decrees (MEDDE, 2013b) impact the  $N_{org}$  flow by imposing storage capacities and spreading restrictions. The Nitrates Directive also applies to farms located in sensitive areas (ZV). Farmers must have available adequate storage capacity sufficient to enable compliance with the minimal storage periods before land spreading (45 days in RSD, 4 months in ICPE or 4 to 7.5 months in ZVs depending on the animal type, the length of time at pasture and the geographical location. Field storage is allowed for less than 10 months (ICPE) or 9 months (ZV) for some manure and poultry droppings. The requirements of the EU Industrial Emissions Directive (IED) also apply to intensive poultry and pig farming by requiring the implementation of Best Available Techniques (BAT) to reduce nitrogen emissions (pit covers, incorporation injection following  $N_{org}$  spreading,).  $N_{org}$  application is prohibited during critical periods or on soils that favor the runoff or leaching of nitrogen applied. In ZV spreading periods are established according to the behavior of the different manure relative to the mineralization of  $N_{org}$ , climatic conditions and technical constraints). Compliance with the 170 kg  $N_{org}$ /ha in ZV is a restriction that can lead the farmer to treat manure. Within ICPE, incorporation after spreading is mandatory within 12 to 24 hours depending on the source of organic nitrogen (solid manure, slurry,).  $N_{org}$  treatment is mandatory under the Nitrates Directive in Reinforced Action Zones (ZARs) where the amount of nitrogen to be applied is higher than 170 kg  $N_{org}$ /ha. Nitrogen treatment is also mandatory under the EU Water Directive in the Loire-Brittany region to ensure the balance of phosphorus fertilization. The treatment becomes an obligation also to transform manure or digestat (resulting from anaerobic digestion) into an amendment (NFU 44-051, (AFNOR, 2016b)) or organic fertilizers (NFU 42-001, (AFNOR, 2016a)).

#### Incentive measures.

In order to meet the requirements of the European directives and its international commitments (reduction of  $NH_3$  by at least 13% by 2030 under the NEC Directive 2001/81/EC), the French government supports farmers in the control of  $N_{org}$ . The "Plan Energie Méthanisation Autonomie Azote"(EMAA) launched in 2013 promotes the development of an anaerobic digestion sector with nitrogen conservation by the digestate used as a fertilizer. For farmers subjected to the IED regulation, financial support has been available since 2017 for investments in BAT. A

new plan to combat green algae blooms in Brittany in 2017 aims at tackling diffuse nitrogen pollution. Various action plans emerged with the signing of the law on the energy transition for green growth (LTECV) in 2015. The 2017 Climate Plan should enable France to contribute more effectively to the fight against climate change. One of the objectives is to reduce the amount of nitrogen fertilizers and the development of anaerobic digestion to integrate 23% of renewable energies in the final gross energy consumption in 2020 and 32% in 2030. Published in 2017, the National Plan Reducing Emissions of Atmospheric Pollutants (PREPA) plans to limit ammonia emissions by encouraging spreading techniques that reduce the volatilization of organic nitrogen. There are also other plans, such as the Farm Business Competitiveness and Adaptation Plan, which helps farm investments. Buildings must be designed to reduce their environmental impact on air and water. Also worth mentioning is the Environmental Farm Certification that mandates fertilizer management or Agro-Environmental and Climatic Measures (MAEC).

## CONCLUSION

For several decades, France has been developing regulatory texts that are generally complemented by action plans or programs to reduce the impact of emissions linked to the management of organic nitrogen. These policies go towards an improvement of the environmental quality but are not enough to reach the balance between economic, health and social performance. In fact, despite the interest of farmers in these incentive schemes, environmental objectives are not necessarily a priority for them.

## REFERENCES

- Agreste (2014). Enquête Pratiques culturales 2011 Agreste les Dossiers n° 21 - juillet 2014, 70p.
- Citepa (2017). [www.citepa.fr](http://www.citepa.fr)
- Loyon, L. (2017). Overview of manure treatment in France. *Waste Management* 61, 516-520.
- MEDDE (2013a). Les surplus d'azote et les gaz à effet de serre de l'activité agricole en France métropolitaine en 2010. Commissariat général au développement durable. *Chiffres et statistiques* 448, 11p.
- MEDDE (2013b). Arrêté du 27/12/13 relatif aux prescriptions générales applicables aux installations relevant du régime de l'enregistrement au titre des rubriques n° « 2101 », 2102 et 2111 de la nomenclature des installations classées pour la protection de l'environnement. *JORF* n°0304 du 31 décembre 2013 page 22393, texte n° 62.

## THE CONFIGURATION OF THE AGRO-FOOD SYSTEM IN THE MEDITERRANEAN BASIN: IMPLICATIONS FOR FOOD SECURITY IN A VULNERABLE AREA

LASSALETTA, L.<sup>1,2</sup>, BONDEAU, A.<sup>2</sup>, SANZ-COBENA, A.<sup>1</sup>, QUEMADA, M.<sup>1</sup>, CRAMER, W.<sup>2</sup>

<sup>1</sup> CEIGRAM, Universidad Politécnica de Madrid, Spain; <sup>2</sup> IMBE (Aix-Marseille Université, CNRS, IRD, Université Avignon), France

### INTRODUCTION

The Mediterranean basin could face an important challenge for assuring food security due to the high vulnerability of its agriculture and the high population density. Indeed the region today is net importer of food and feed. The food demand can grow not only for an increase in the population but also for a progressive transition from the so-called Mediterranean diet towards a “western-type” diet (Lassaletta et al. 2014). On the other hand, climate change can exacerbate water scarcity affecting agricultural production and also increasing land degradation processes (Fader et al. 2016). We undertake this study to better understand the evolution and conformation of the agro-food system of contrasted areas of the Mediterranean basin. To do so, we analyze the levels and flows of nitrogen (N) between the core compartments of the system (crop, animal, human) from 1961 to 2013. We aim to detect the core trajectories and relevant changes, distinguishing hot drivers and key parameters such as crop and livestock efficiencies, human diet, trade and the degree of external dependency.

### MATERIAL AND METHODS

We follow the Generic Representation of Agro-food Systems approach (GRAFS). Functional relationships between crop farming, livestock systems, and human nutrition are expressed in terms of Ntransfer (Billen et al. 2014). Most of the results were obtained after processing the information provided by FAOSTAT (see Lassaletta et al. 2016 and references cited there for a detailed description of the budgeting methods). We have aggregated the countries in 4 regions (South Mediterranean, East Mediterranean, Ex-Yugoslavia, and North Mediterranean). Due to their particularities France and Egypt have been analyzed individually. By establishing a series of algorithms the local or imported origin of the food and feed was estimated as well as the degree of regional self-sufficiency for vegetal and animal products. Nitrogen surplus in the cropping systems was used as a proxy of potential pollution.

### RESULTS AND DISCUSSION

Total human demand of vegetal products has increased two-fold (1.6 TgN in 2013) in the entire region and three-fold for animal products (1.7 TgN in 2013). The largest share of the increase of vegetal demand was linked to the population growth while for animal products dietary changes contributed the most. All the regions and countries presented today a *per capita* protein ingestion above the minimum recommended by the World Health Organization while this was not the case for some southern and eastern countries during the first decades (1960-1980). All the countries of the Northern region highly surpassed 33% of animal protein ingestion that characterizes the Mediterranean diet, by contrary in Southern and Eastern regions where the observed increases put the current diet in the recommended standards.

Total crop and livestock production in the basin has increased more than two-fold in both cases (6.5 TgN and 1.8 TgN in 2013, respectively). The crop surface has hardly changed and the observed increases in production responded to yield improvements. With the exception of France, crop nitrogen use efficiency (NUE) has slightly dropped. The N surpluses have doubled (5.9 TgN in 2013). Despite the weighted averaged per area N surpluses are below critical values (80 kgN.ha<sup>-1</sup>.y<sup>-1</sup>) the vulnerability of the freshwater systems together to a bad managed intensive crop and livestock areas could exacerbate the problem of access to enough clean water. Regardless of the observed increase in the efficiency of animal systems their low efficiency in the transformation of vegetal into animal protein (0.07-0.13 range for ruminants and 0.18-0.24 for monogastric in 2013) entails that small increases in the production generated significant increases of the feed demand.

As a result of the evolution of these system components (supply and demand) self-sufficiency has dramatically decrease for both vegetal and animal products during the last five decades. Only France was a net exporter country in 2013, even considering the significant import of soybeans used to feed the livestock. The local production of vegetal products is enough to provide food for the people in all regions; however it is by far insufficient for feeding the increasing livestock. Animal feed local and imported is accounting for the largest part of the total protein use in the agro-food system of the Mediterranean region (Fig. 1)

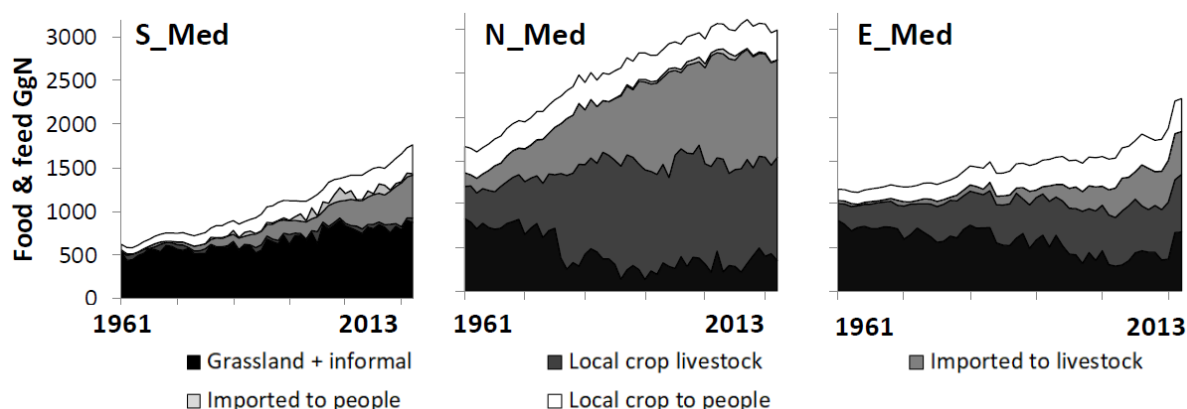

Figure 1. Evolution of the fate of protein (expressed as nitrogen) in the agro-food system of some Mediterranean regions. The allocation of protein to human food and animal feed and the local or imported origin is showed.

#### Conclusion

Increases in crop and livestock production during the last 54 years have not been large enough to fulfill an increasing local demand associated with population rise and dietary changes. People of the Mediterranean basin are the more and more dependent on international trade and this situation could be worsening if climate change affects yields. Better crop and livestock management, together to structural changes such as better crop-livestock integration and human dietary changes, could be crucial to assure food security in the coming decades.

**Acknowledgements:** L. Lassaletta was supported by the H2020 project LUC4C and by a ‘Ramon y Cajal’ research contract from the Spanish Ministry of Economy and Competitiveness.

#### REFERENCES

- Billen, G., Lassaletta, L., Garnier, J., 2014. A biogeochemical view of the global agro-food system: Nitrogen flows associated with protein production, consumption and trade. *Global Food Security* 3, 209-219.
- Fader, M., Shi, S., von Bloh, W., Bondeau, A., Cramer, W., 2016. Mediterranean irrigation under climate change: more efficient irrigation needed to compensate for increases in irrigation water requirements. *Hydrol. Earth Syst. Sci.* 20, 953-973.
- Lassaletta, L., Billen, G., Garnier, J., Bouwman, L., Velazquez, E., Mueller, N.D., Gerber, J.S., 2016. Nitrogen use in the global food system: past trends and future trajectories of agronomic performance, pollution, trade, and dietary demand. *Environ. Res. Lett.* 11, 095007.
- Lassaletta, L., Billen, G., Romero, E., Garnier, J., Aguilera, E., 2014. How changes in diet and trade patterns have shaped the N cycle at the national scale: Spain (1961–2009). *Reg. Environ. Change* 14, 785-797.

# 20<sup>th</sup> Nitrogen Workshop

## Coupling C-N-P-S cycles

June 25-27, 2018  
Le Couvent des Jacobins, Rennes – France

### **Session III: Local process studies – Oral presentations**

## KEYNOTE PRESENTATION: INTERACTIONS BETWEEN C-N-P CYCLES FROM THE POINT OF VIEW OF SOIL MICROBIAL ECOLOGY

WANEK, W.<sup>1</sup>, MOOSHAMMER, M.<sup>2</sup>, RICHTER, A.<sup>3</sup>

<sup>1</sup> Department of Microbiology and Ecosystem Science, University of Vienna, Austria; <sup>2</sup> Affiliation, Country; <sup>3</sup> Affiliation, Country

### INTRODUCTION

In the biosphere the cycles of C, N and P (and S) are intimately linked through their contribution to essential organic biomolecules such as lipids, proteins, nucleic acids and (amino)sugar polymers, together largely constituting the cellular make-up of microbes, plants and animals. Soil microbial communities have been shown to be largely homeostatic in terms of their cellular C:N:P ratio (Xu et al. 2013) but in the environment face resources that by far do not match their elemental composition (Mooshammer et al. 2014b, Zechmeister-Boltenstern et al. 2015). These resource C:N:P imbalances trigger different mechanisms that allow microbes to thrive and grow on these imbalanced food resources (Mooshammer et al. 2014b).

### RESULTS AND DISCUSSION

#### Elemental imbalances, decomposer adaptations and microbial processing of organic matter

Elemental imbalances range between 2-50 for C:N, 7-340 for C:P and 3-7 for N:P when microbes decompose soil organic matter, leaf litter, dead roots or wood (Table 1) (Mooshammer et al. 2014b). Adjustments in the production of extracellular enzymes to mine for limiting elements and in element use-efficiencies are most important to bridge this gap (Figure 1). We will demonstrate how changes in microbial carbon-use efficiency (CUE) and growth affect soil carbon sequestration and soil respiration, for example causing increases in soil organic C in grasslands of higher plant diversity. Microbial CUE decreases with increasing resource C:N ratios, though weakly, following stoichiometric reasoning. At the same time we could also show that microbial nitrogen-use efficiency (NUE) increases with increasing resource C:N ratios and C:N imbalances (Mooshammer et al. 2014a). An increase in microbial NUE however also implies a reduction in gross N mineralization and therefore a slow-down of inorganic N cycling. In contrast, factors that cause a decline in microbial NUE trigger faster N mineralization, eventually followed by a more open N cycle with greater N losses from soils.

*Table 1. Globally averaged element ratios in potential resources and in soil microbial biomass, and stoichiometric imbalances between resources and microbes calculated as the ratio of X:Y<sub>resource</sub> over X:Y<sub>microbes</sub>.*

Organic material	Molar C:N:P	C:N imbalance	C:P imbalance	N:P imbalance
Wood	14.100:40:1	50	336	7
Dead roots	4.180:43:1	14	100	7
Leaf litter	3.055:43:1	10	73	7
Soil organic matter	287:17:1	2	7	3
Soil microbes	42:6:1			

#### Non-stoichiometric controls on microbial C, N and P cycling

Beyond stoichiometric controls on element–use efficiencies we will analyze other potential controls of microbial C, N and P cycle processes. We here focus on whether gross decomposition and mineralization processes are rather driven by extracellular enzyme contents or substrate availability. The content of decomposable substrate and its stabilization or accessibility are overriding factors, controlling the depolymerization of high-molecular weight organic matter in soils, as shown by a lack of relationship with potential soil enzyme activities but strong modulating effects of soil texture, pH and exchangeable calcium at local to continental scales. Microbial activity in soils is therefore strongly constrained by factors that render resources inaccessible, e.g. via soil aggregation or physical binding to mineral surfaces (unpublished data).



### Disturbance effects on microbial C, N and P cycling

Predicted changes in the intensity and frequency of climate extremes necessitate a better mechanistic understanding of the stress response of soil microbial communities and related C, N and P processes. By analyzing the resistance and resilience of microbial C, N, and P cycling processes and microbial community composition in decomposing plant litter to transient, but severe, temperature disturbances (freeze-thaw and heat wave) we show a more rapid cycling of C and N but a down-regulation of microbial P cycling shortly after disturbance (Mooshammer et al. 2017). While C and N processes and microbial community structure recovered rapidly to control levels, we found a slow recovery of P mineralization rates. Moreover, the functional and structural responses to the two distinct temperature disturbances were markedly similar, suggesting that direct negative physical effects and costs associated with the stress response were comparable. The decoupling of microbial P processes from C and N processes and its persistent down-regulation after stress is alarming and must be followed in soil systems.

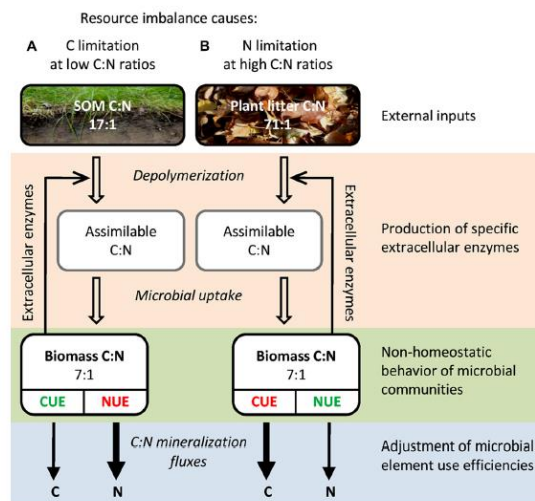

Figure 1. Simplified schematic representation of important C:N components and fluxes during organic matter breakdown by litter or soil microbial communities. Differences in C:N:P stoichiometry between (A) soil organic matter and (B) plant litter result in distinct elemental limitations for the microbial communities, with different implications for element mineralization fluxes. Mechanisms for microbial adaptation to resource imbalances are indicated (Mooshammer et al. 2014b).

### REFERENCES

- Mooshammer, M., F. Hofhansl, A. H. Frank, W. Wanek, I. Hammerle, S. Leitner, J. Schneckner, B. Wild, M. Watzka, K. M. Keiblinger, S. Zechmeister-Boltenstern, and A. Richter. 2017. Decoupling of microbial carbon, nitrogen, and phosphorus cycling in response to extreme temperature events. *Science Advances* **3**.
- Mooshammer, M., W. Wanek, I. Hammerle, L. Fuchslueger, F. Hofhansl, M. Takriti, B. Wild, K. M. Keiblinger, S. Zechmeister-Boltenstern, and A. Richter. 2014a. Adjustment of microbial nitrogen use efficiency to carbon: nitrogen imbalances regulates soil nitrogen cycling. *Nature Communications* **5**: 3694.
- Mooshammer, M., W. Wanek, S. Zechmeister-Boltenstern, and A. Richter. 2014b. Stoichiometric imbalances between terrestrial decomposer communities and their resources: mechanisms and implications of microbial adaptations to their resources. *Frontiers in Microbiology* **5**:article 22.
- Xu, X. F., P. E. Thornton, and W. M. Post. 2013. A global analysis of soil microbial biomass carbon, nitrogen and phosphorus in terrestrial ecosystems. *Global Ecology and Biogeography* **22**:737-749.
- Zechmeister-Boltenstern, S., K. M. Keiblinger, M. Mooshammer, J. Penuelas, A. Richter, J. Sardans, and W. Wanek. 2015. The application of ecological stoichiometry to plant-microbial-soil organic matter transformations. *Ecological Monographs* **85**:133-155.

## ZINC CHELATES INFLUENCED N<sub>2</sub>O EMISSIONS AND NITRIFYING AND DENITRIFYING COMMUNITIES IN TWO DIFFERENT CROP SYSTEMS

MONTOYA, M.<sup>1</sup>, CASTELLANO-HINOJOSA, A.<sup>2</sup>, VALLEJO, A.<sup>1</sup>, ÁLVAREZ, JM.1, BEDMAR, EJ.2, RECIO, J.<sup>1</sup>, GUARDIA, G.<sup>1</sup>

<sup>1</sup> ETSI Agronómica, Alimentaria y de Biosistemas, Universidad Politécnica de Madrid, Spain; <sup>2</sup> Department of Soil Microbiology and Symbiotic Systems, Estación Experimental del Zaidín, Agencia Estatal CSIC, Spain

### INTRODUCTION

Fertilization with micronutrients (e.g. zinc, Zn) is essential to overcome the global nutritional problems associated with human deficiencies. An adequate nutrient balance requires the management of macronutrients (e.g. nitrogen, N) fertilization (Venterea et al., 2016) and its interactions with micronutrients (e.g. Zn), to find synergistic effects between nutrients, and improve crop quality through biofortification (Cakmak et al., 2017). However, it is pivotal to reduce environmental pollution, e.g. the emission of nitrous oxide (N<sub>2</sub>O), without compromising food security in a context of increasing world population. Widespread products which inhibit nitrification, such as dicyandiamide (DCD) or 3,4-dimethylpyrazole phosphate (DMPP), act as metal chelators. Therefore, chelating fertilizers, which are used to apply micronutrients with enhanced efficacy (Alvarez, 2010), could influence nitrification and other metal-dependent biochemical processes such as denitrification. The response of nitrous oxide (N<sub>2</sub>O) emissions to N fertilization has been broadly assessed, but little is known about the effect of micronutrient fertilizers and their interaction with nitrogen (N) on greenhouse gas (GHG) emissions and soil microbial processes involved in N<sub>2</sub>O fluxes.

### MATERIAL AND METHODS

Two field experiments were located in the National Center of Irrigation Technology, “CENTER” in the Madrid region (Spain). The soil was an alkaline *Typic xerofluvent* with a silt loam texture and low organic matter content in the upper horizon (0-20 cm). The winter wheat (*Triticum aestivum* L. ‘Ingenio’) and the maize (*Zea mays* L. ‘SY Miami’) experiments were carried out from October 2015 to July 2016 and May 2017 to September 2017, respectively. The maize crop was irrigated through sprinklers, while no irrigation was applied to winter wheat. A total of 12 plots (20m<sup>2</sup> and 144m<sup>2</sup>, respectively) were arranged in a three-replicated randomized block design. Each plot was a result of two N rates as urea (0, N0 and 120 kg N ha<sup>-1</sup>, U) with two Zn sources: control, no Zn application (Zn0) and Zn applied with a mixture of chelating compounds (Zn-DTPA-HEDTA-EDTA, ZnCH).

### GHG sampling and analyses

During the first month after fertilization, samples of gases were taken 2-3 times per week considering it is the most critical period of high gas emissions. Afterwards, the frequency of sampling was decreased progressively, but increasing after rainfall events. The GHG (N<sub>2</sub>O, CH<sub>4</sub> and CO<sub>2</sub>) fluxes were measured using the closed chamber technique (Sanz-Cobena et al., 2012) and their concentrations were quantified by gas chromatography, using a gas chromatograph (GC).

### DNA extraction and quantification of nitrifying and denitrifying microbial communities

Soil samples were taken from the field experiment with wheat. Total DNA was extracted from 500 mg of soil using commercial kit PowerSoil® DNA Isolation and DNA concentration was measured using the Qubit® ssDNA assay kit. The size of nitrifying communities was estimated by quantitative PCR (qPCR) of the *amoA* gene from ammonia-oxidizing Bacteria (AOB) and Archaea (AOA). Similarly, denitrifying communities were estimated by qPCR of the *nirK*, *nirS*, *norB* and *nosZ* genes using primers and thermal conditions described previously. The total bacterial and archaeal communities were quantified using the 16S rRNA gene as a molecular marker. qPCR was performed in an ABI Prism 7900 Sequence Detection System employing the fluorophore SYBR Green to quantify the total

abundance of targeted genes. Standard curves were obtained using serial dilutions (ranging from  $10^8$  down to  $10^2$  copies  $\mu\text{l}^{-1}$ ) of linearized plasmids containing the targeted genes cloned in.

## RESULTS AND DISCUSSION

In maize, cumulative  $\text{N}_2\text{O}$  emissions (Fig. 1) were significantly higher in N fertilized treatments (U), independently of Zn, than in unfertilized N treatments (NO), but small differences were found in wheat. Concerning Zn treatments, cumulative losses were significantly increased with the application of Zn chelate (ZnCH) combined with U in maize. Contrarily, wheat crop showed a decreased in cumulative  $\text{N}_2\text{O}$  emissions with U+ZnCH treatment. Besides, we observed a decrease in the total abundance of nitrifying and denitrifying communities with U+ZnCH treatment in wheat, except the gene involved in transforming  $\text{N}_2\text{O}$  to  $\text{N}_2$  (*nosZ* gene) which was increased. In high moisture conditions, Pramanik and Kim (2016) reported an increase in  $\text{N}_2\text{O}$  losses after the addition of EDTA in a submerged paddy crop which was in agreement with our results in maize. However, the understanding of how Zn chelate modulates soil nitrifying and denitrifying microbiota under irrigated conditions is still under study.

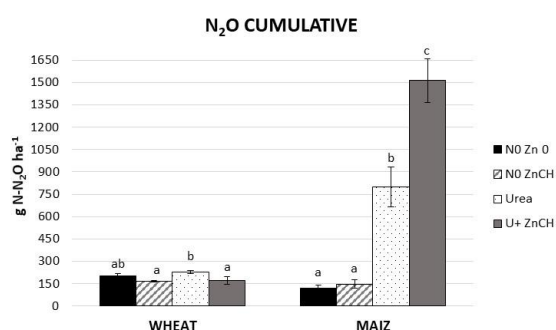

Figure 1. Total cumulative  $\text{N}_2\text{O}$ -N emissions in winter wheat and maize crops amended with Zn fertilizer (Zn- DTPA-HEDTA-EDTA, ZnCH) and without Zn (Zn0) combined with two N application rates (0, NO, and  $120 \text{ kg N ha}^{-1}$ , U).

## CONCLUSION

Our results demonstrated that in the rainfed crop, the application of synthetic chelates can be a promising strategy to decrease  $\text{N}_2\text{O}$  losses. However, the opposite was observed in an irrigated crop.

## REFERENCES

- Alvarez JM., 2010. Influence of soil type and natural Zn chelates on flax response, tensile properties and soil Zn availability. *Plant Soil*, 328, 217–233.
- Cakmak I., McLaughlin MJ., White P., 2017. Zinc for better crop production and human health.
- Pramanik P., Kim PJ., 2017. Contrasting effects of EDTA applications on the fluxes of methane and nitrous oxide emissions from straw-treated rice paddy soils. *Journal of the Science of Food and Agriculture*, 97, 278-283.
- Sanz-Cobena A., Sánchez-Martín L., García-Torres L., Vallejo A., 2012. Gaseous emissions of  $\text{N}_2\text{O}$  and NO and  $\text{NO}_3^-$  leaching from urea applied with urease and nitrification inhibitors to a maize (*Zea mays*) crop. *Agr. Ecosyst. Environ.* 149, 64-73.
- Venterea R.T., Coulter J.A., Dolan M.S., 2016. Evaluation of intensive “4R” strategies for decreasing nitrous oxide emissions and nitrogen surplus in rainfed corn. *J. Environ. Qual.*, 45, 1186-1195.

## EVALUATION OF N<sub>2</sub>O AND NH<sub>3</sub> EMISSIONS FROM THE USE OF DIGESTATE AS FERTILIZER ON SILAGE MAIZE

VERDI L.<sup>1</sup>, KUIKMAN P.J.<sup>2</sup>, ORLANDINI S.<sup>1</sup>, MANCINI M.<sup>1</sup>, NAPOLI M.<sup>1</sup>, DALLA MARTA A.<sup>1</sup>

<sup>1</sup>Department of Agrifood Production and Environmental Sciences (DISPAA), University of Florence, Piazzale delle Cascine 18 – 50144 Firenze, Italy; <sup>2</sup>Alterra, Wageningen University and Research Centre, P.O. Box 47, 6700 AA Wageningen, The Netherlands

### INTRODUCTION

Fertilization represent one of the more effective strategy to maximize agricultural production and meet the growing global food demand. In particular, nitrogen (N) represents the main input to maximize crop yields. However, the uncontrolled use of N-based fertilizers and the low efficiency of application methods have led to considerable N losses through volatilization, leaching and soil erosion with consequentially detrimental ecological effects (eutrophication, decrease in biodiversity of natural lands, atmosphere, surface waters and groundwater). Therefore, N-based by-product with a low environmental production cost and high N content represents an effective strategy to reduce those impacts while maintaining high yields. In this sense, the use of digestate from anaerobic digestion of slurries to replace mineral fertilizers is considered an opportunity to reduce environmental impacts of fertilization (Pezzolla et al., 2012). This is mainly due to the low impact of digestate production, as waste of biogas, and to the high N easily available for plants. However, a mismanagement of digestate can led an increase of N<sub>2</sub>O and NH<sub>3</sub> emissions with detrimental effects of the environment. The evaluation of N emissions from the use of digestate is fundamental on the assessment on his potential as fertilizer and on the reduction of greenhouse gases emissions from agriculture.

### MATERIAL AND METHODS

The experimental field is located at the Istituto Tecnico Agrario Statale (ITAGR), Firenze (43° 47' 07"N 11° 13' 11" E), Central Italy. Twelve tanks (volume 1 m<sup>3</sup> each) creating a controlled environment by preventing any interactions with surroundings conditions were utilized. A silty-clay soil was used and soil layers (0-30; 30-60; 60-90 cm of depth) were kept divided to reproduce soil profile into the tanks. Water supply was provided by a drip irrigation system. 13 seeds of silage maize (Var. Ronaldinho) were sowed on (17th June 2016) to reproduce a field plant density of 12.000 plant ha<sup>-1</sup>. Three fertilization treatments were tested: liquid fraction of digestate (pig slurries + triticale straw + olive cake + sorghum silage), urea and no fertilization (control). For each treatment, four replicates (tanks) were carried out in a randomized block design. The dose of each fertilizer was determined in order to supply 150 Kg ha<sup>-1</sup> of N. To this aim, N content and type (NH<sub>4</sub><sup>+</sup> and NO<sub>3</sub><sup>-</sup>) of digestate (Kg) were laboratory determined (N = 3.14 g Kg<sup>-1</sup>; NH<sub>4</sub><sup>+</sup> = 2.81 g Kg<sup>-1</sup>; NO<sub>3</sub><sup>-</sup> = 0.081 g Kg<sup>-1</sup>). According to Vallejo at al. (2005), digestate was manually applied by replacing slurry injection method, while urea was conventionally spread. In both treatments, fertilization was split into two doses: 18 days (F1) and 36 (F2) days after sowing. For the monitoring gas emissions twelve static chambers (one per tank) were constructed as described by Parkin and Venterea (2010). Chambers are composed of two parts: the lid of the chamber (25 cm high and 20 cm of diameter) and the anchor system (15 cm high with a diameter of 20 cm), to be inserted into the soil as support. Anchor system was positioned between plant rows immediately after sowing to reduce roots disturbance. Gas samplings were performed by means of a portable gas analyser (Madur Sensonic X-CGGM 400) that uses Nondispersive Infrared technology (NDIR) for NH<sub>3</sub> detection and electrochemical technology for N<sub>2</sub>O. Gas fluxes were calculated starting from the gas concentration into the chamber, chamber dimensions (area and volume), closing time and molecular weight of each gas. Evaluation of fertilization potential was determined through the analysis of yields (t DM ha<sup>-1</sup>), N uptake by crops and N soil content before sowing and after harvest. The statistical analysis was performed using IBM SPSS Statistics 20. Dependence of emission fluxes on fertilizers was investigated by means of ANOVA model and Kruskal – Wallis test, when it wasn't possible to satisfy all of the assumption of ANOVA analysis.

### RESULTS AND DISCUSSION

During F1, N<sub>2</sub>O emissions were higher in digestate than urea. However, in F2 emissions were higher than F1 but we did not observe significant differences between the two treatments (Tab. 1). In accordance to Bouwman (1996) and Pezzolla et al. (2012), the higher N<sub>2</sub>O emissions from digestate are mainly due to its water and organic C content that increases soil denitrification effect with greater potential for the production of N<sub>2</sub>O as well, and the spreading method, injection, which enhanced interactions between digestate and soil microbial community. NH<sub>3</sub> emission in F1 were higher in urea than digestate (Tab. 1). In F2, emissions were lower than F1 and no significant differences between the two treatments were observed (Tab. 1). This is mainly due to the relation between NH<sub>3</sub> emissions and soil water content. In F1, the absence of rainfall ensured higher NH<sub>3</sub> emissions in urea that was left on soil surface after spreading with a scarce dissolution of the fertilizer into the soil. In F2, 7.4 mm of rainfall occurred and no differences were observed between digestate and urea NH<sub>3</sub> emissions. Moreover, distribution method plays a key role on NH<sub>3</sub> emission dynamics. In accordance to Wulf et al. (2002), the more the fertilizer is incorporated into the soil, the less NH<sub>3</sub> is lost through volatilization. Therefore, injection of digestate into the soil enhanced lower NH<sub>3</sub> emissions than urea. Concerning cumulative data, they were referred to a 25-days period as we considered 11 days of measurements after each fertilization (22 days in total) plus the period left between the end of F1 measurements and F2 (3 days) (experiment started in 4<sup>th</sup> of July 2016 and finished on 28<sup>th</sup> of July 2016). The analysis of N cumulative emissions (N<sub>2</sub>O + NH<sub>3</sub>) showed that urea lost more N than digestate (Tab. 1). Through the ratio between the emissions from digestate and urea (%) the relative reduction of N emissions obtainable from the use of each fertilizer was assessed. Based on our results, the net reduction of total N emissions produced by the use of digestate (2.867 Kg N ha<sup>-1</sup>) compared to urea (3.759 Kg N ha<sup>-1</sup>) is 23.73%. More specifically, the digestate allowed reducing N–NH<sub>3</sub> emissions by 66.32% while increasing N–N<sub>2</sub>O emissions by 22.63%, showing that the main factor affecting the impacts of tested fertilizers is volatilization of NH<sub>3</sub>. The analysis of yields shows no significant difference between the two treatments ( $\alpha = 0.05$ ), confirming the fertilization effect of digestate compared to urea (13.63 t DM ha<sup>-1</sup> and 13.24 t DM ha<sup>-1</sup>, respectively). This is also confirmed by N uptake of plants that was not significantly different between the two treatments at a significance level  $\alpha = 0.05$  (129.79 Kg N ha<sup>-1</sup> for digestate and 131.30 Kg N ha<sup>-1</sup> for urea). Results on soil analysis after maize harvest showed that tanks fertilized with digestate had a lower content of N than those treated with urea (0.125% and 0.167%, respectively). Therefore, we can assume that N emissions from digestate last longer than expected probably due to denitrification losses occurred between measuring period and harvest. Finally, based on the analysis on water collected from each tank, N was not lost through leaching.

## CONCLUSION

The use of digestate as fertilizer on silage maize is an effective method to lower total emissions of N. Together with a better environmental performance, the measurements on crop production showed that the digestate provide yields comparable to those obtainable with urea. However, N content in digestate is extremely low so that a large amount of product is required to satisfy the nutrient demand of maize. It means that several passes on the field are needed with consequent effects on GHG emissions from tractors, soil compaction and total economic cost. On the other hand, urea is a product of an industrial process that also has significant impacts in terms of gas emissions and economic costs. So that, a complete cost-benefit analysis of the entire process may be necessary to support farmers decisions.

Table 1. N<sub>2</sub>O and NH<sub>3</sub> emission fluxes in first (F1), second fertilization (F2) and cumulative monitoring period of 25 days (Cum) expressed in ppm and Kg N ha<sup>-1</sup>.

		Unit	Digestate	Urea	Control
N <sub>2</sub> O	F1	ppm	11,963	1,930	1,540
	F2	"	32,390	32,372	6,965
	Cum	"	44,353	34,302	8,505
NH <sub>3</sub>	F1	"	27,750	100,265	8,086
	F2	"	9,488	10,250	7,967
	Cum	"	37,238	110,515	16,053
Total N		"	81,591	144,817	24,558
N <sub>2</sub> O	F1	Kg N ha <sup>-1</sup>	0,584	0,094	0,075
	F2	"	1,581	1,580	0,340
	Total	"	2,165	1,675	0,415
NH <sub>3</sub>	F1	"	0,523	1,891	0,153
	F2	"	0,179	0,193	0,165
	Total	"	0,702	2,084	0,318
Total N		Kg N ha <sup>-1</sup>	2,867	3,759	0,733

**Acknowledgements:** The author thank Gerard Velthof for technical assistance during flux equation assessing and Martin Knotters for the statistical support during elaboration of the data. Moreover, author thank Azienda Agricola Marchese De' Frescobaldi, Fattoria di Corte for kindly providing digestate and Roberto Vivoli from DISPAA for his assistance in the field.

## REFERENCES

- Bouwman A.F., 1996. Direct emission of nitrous oxide from agricultural soils. *Nutr. Cycl. Agroecosys.* 46, 57-70.
- Parkin T.B. and Venterea R.T. 2010. Sampling Protocols. Chapter 3. Chamber-Based Trace Gas Flux Measurements. In: *Sampling Protocols*. R.F. Follett, editor. p. 3-1 to 3-39. Available at: [www.ars.usda.gov/research/GRACenet](http://www.ars.usda.gov/research/GRACenet)
- Pezzolla D., Bol R., Gigliotti G., Sawamoto T., Lopez A.L., Cardenas L., Chadwick D., 2012. Greenhouse gas (GHG) emissions from soils amended with digestate derived from anaerobic treatment of food waste. *Rapid Commun. Mass Sp.* 26, 2422-2430.
- Vallejo A., Garcia-Torres L., Diez J.A., Arce A., Lopez-Fernandez S., 2005. Comparison of N losses (NO<sub>3</sub> N<sub>2</sub>O NO) from surface applied, injected or amended pig slurry of an irrigated soil in a Mediterranean climate. *Plant Soil* 272, 313-325.
- Wulf S., Maeting M., Clemens J., 2002. Application technique and slurry co-fermentation effects on ammonia, nitrous oxide and methane emissions after spreading I: Ammonia volatilization. *J Environ Qual* 31, 1789-1794.

## TRI-ISOTOPE ( $^{13}\text{C}$ , $^{15}\text{N}$ , $^{33}\text{P}$ ) LABELING METHOD TO QUANTIFY RHIZODEPOSITION FROM A LEGUME

STEVENEL, P.<sup>1</sup>, FROSSARD, E.<sup>1</sup>, ABIVEN, S.<sup>2</sup>, RAO, I.M.<sup>3</sup>, TAMBURINI, F.<sup>1</sup>, AND OBERSON, A.<sup>1</sup>

<sup>1</sup> ETH Zurich, Switzerland; <sup>2</sup> University of Zurich, Switzerland; <sup>3</sup> International Center for Tropical Agriculture (CIAT), Cali, Colombia

### INTRODUCTION

Belowground carbon (C), nitrogen (N) and phosphorus (P) inputs of plants via roots and rhizodeposition play a key role in the cycling of these elements. Legume belowground N is an often-overlooked part when estimating the symbiotic  $\text{N}_2$  fixation. Furthermore, C:N:P ratios of roots and rhizodeposition may affect the decomposition and nutrient release from these inputs. Better understanding the belowground C, N and P amounts and their turnover in soil is therefore crucial for the understanding of cycling of these elements in soil-plant systems.

Rhizodeposition is defined as release of all kinds of compounds lost from living plant roots (Uren 2001). Rhizodeposition of C and N is usually studied using isotope labeling, for C typically using exposure to labeled  $\text{CO}_2$  (Kuzyakov and Schneckenberger 2004) while for N stem and leaf feeding techniques dominate (Wichern et al. 2008). Studies on belowground P inputs using P radioisotopes are rare. Foyjunnessa et al. (2016) used a stem feeding method to track  $^{33}\text{P}$  labeled belowground P inputs from canola in soil. The percentage of an element derived from rhizodeposition in the soil is calculated on the assumptions that isotopic composition (IC) of roots and rhizodeposition is identical, and that the IC of roots is constant over time (i.e., IC of root system does not significantly change during experimental period) and space (i.e., different root segments have same IC). The validity of these assumptions has hardly been checked.

The overall goal of our project is to study the belowground C, N and P input of a legume in highly weathered tropical soil along a soil P availability gradient. To this end, we i) developed a tri-isotope labeling protocol for simultaneously tracking belowground C, N and P inputs, ii) determined the elemental and isotopic composition of roots and rhizodeposition for C, N and P, and (iii) tested the validity of the assumptions underlying the quantification of rhizodeposition. We will show the outcome of the method testing and discuss the implications.

### MATERIAL AND METHODS

The tropical legume *Canavalia brasiliensis* was used as model plant for the development of the tri-isotope labeling method. This rapidly growing legume develops a strong stem suitable for a cotton wick stem feeding with a solution containing  $^{15}\text{N}$  labeled urea (Wichern et al. 2008) and carrier free  $\text{H}_3^{33}\text{PO}_4$  (Foyjunnessa et al. 2016). The day before stem feeding, plants were in a chamber exposed to a single pulse of  $^{13}\text{CO}_2$  atmosphere (Kuzyakov and Schneckenberger 2004). In a series of experiments, we assessed the IC of roots and rhizodeposition while a rhizobox experiment allowed determining the  $^{15}\text{N}$ ,  $^{13}\text{C}$  and  $^{33}\text{P}$  tracer distributions within the root system over time and space. Experiments were conducted under greenhouse conditions in C-free sand using nutrient solutions with low N and P concentrations. Before harvest, the solution containing rhizodeposition (termed percolate) was evacuated using a peristaltic pump connected to perforated pots, and roots were hand picked carefully. Total C, N and P contained in shoots, root samples and in the percolate was analysed. The  $^{33}\text{P}$  was determined using a beta counter (TRI-CARB 2500 TR, liquid scintillation analyzer, Packard Instruments, Meriden, CT) to derive the specific activity ( $^{33}\text{P}/^{31}\text{P}$ ). Nitrogen, C,  $^{15}\text{N}/^{14}\text{N}$  and  $^{13}\text{C}/^{12}\text{C}$  of plant and liquid samples were determined by EA-IRMS (vario PYRO cube, Elementar, Germany and IsoPrime100 IRMS, Isoprime, United Kingdom).

### RESULTS AND DISCUSSION

The plants took up all the  $^{15}\text{N}$  and  $^{33}\text{P}$  labeled solution within less than 24 hours. The tri-isotope labeling procedure provided  $^{13}\text{C}$ ,  $^{15}\text{N}$  and  $^{33}\text{P}$  labeled roots and rhizodeposition.

A high isotopic enrichment was observed in sand, only 1 day after labeling, reflecting a high enrichment of rhizodeposition released during a short time span. Rapid allocation of assimilated C to rhizodeposits has been reported in earlier studies. However, for N and P the further development with time of the enrichment and activity, respectively, of roots and rhizodeposition suggests that highly enriched rhizodeposits might be an artefact generated with the labeling technique, as by Gasser et al. (2015) reported for  $^{15}\text{N}$  labeled clover.

Progressive translocation of  $^{15}\text{N}$  and  $^{33}\text{P}$  was similarly observed from aerial plant parts to the root system over time. This suggests that for these two isotopes the stem feeding is not a pulse labeling in the strict sense, but is continuous during some days. Young root sections showed a higher  $^{15}\text{N}$  enrichment and higher specific activities than old root sections (Table 1), except for  $^{13}\text{C}$  isotopic enrichment that decreased due to the dilution effect resulting from growth. N and P were thus translocated for the development of new roots, while newly assimilated C was used for their growth.

## CONCLUSION

Belowground C, N and P inputs can simultaneously be isotope labeled to track their fate in soil-plant systems. However, the assumptions behind the equation used for determining rhizodeposition are most probably violated. The labeling is not homogeneous within the root system and not constant over time. Investigations are ongoing to evaluate the bias induced in rhizodeposition estimates.

Table 1. Total N and  $^{15}\text{N}$  distribution 8 days after stem labelling 50-day old *Canavalia brasiliensis* plants.

		DM	N uptake	atom% $^{15}\text{N}$	recovery
		[g]	[mg]	excess	[%]
shoot	total	0.93	29	0.83	74
root	total	0.58	7.9	0.31	8.8
	r1w<0 <sup>a</sup>	0.12	1.1	0.28	1.0
	r2-8dal <sup>b</sup>	0.08	1.2	0.68	2.8

<sup>a</sup>roots grown 1 week before labeling; <sup>b</sup>roots grown between 2 and 8 days after labeling

## REFERENCES

- Foyjunnessa, McNeill A, Doolette A, Mason S, McLaughlin MJ (2016) Use of P-33 to trace in situ the fate of canola below-ground phosphorus, including wheat uptake in two contrasting soils. *Crop & Pasture Science* 67: 726-738.
- Gasser M, Hammelehle A, Oberson A, Frossard E, Mayer J (2015) Quantitative evidence of overestimated rhizodeposition using N-15 leaf-labelling. *Soil Biol Biochem* 85: 10-20.
- Kuzyakov Y, Schneckenberger K (2004) Review of estimation of plant rhizodeposition and their contribution to soil organic matter formation. *Arch Agron Soil Sci* 50: 115-132.
- Uren NC (2001) Types, amounts, and possible functions of compounds released into the rhizosphere by soil-grown plants. In: R Pinton, Z Varanini, P Nannipieri (eds) *The Rhizosphere - Biogeochemistry and Organic Substances at the Soil-Plant interface*. Marcel Dekker, New York, USA.
- Wichern F, Eberhardt E, Mayer J, Joergensen RG, Muller T (2008) Nitrogen rhizodeposition in agricultural crops: Methods, estimates and future prospects. *Soil Biol Biochem* 40: 30-48.



**SILICON INCREASES LEAF LIFE SPAN IN N-DEPRIVED BRASSICA NAPUS L.**HADDAD, C.<sup>1</sup>, ARKOUN, M.<sup>2</sup>, YVIN, J.C.<sup>2</sup>, ETIENNE, P.\*<sup>1</sup>, LAINE, P.\*<sup>1</sup><sup>1</sup>INRA, UMR 950 Ecophysiologie Végétale, Agronomie et nutrition N,C,S (EVA), France . \*PhD supervisors ; <sup>2</sup>Centre Mondial de l'Innovation – Roullier, France**INTRODUCTION**

*Brassica napus* L. is an oleaginous crop requiring high nitrogen (N) inputs (140-200 kg N ha<sup>-1</sup> year<sup>-1</sup>). Nevertheless, rapeseed is characterized by a poor N remobilization (Avice and Etienne, 2014). Indeed, leaves fall with a high N contents (2-2.5%) that may lead to environmental pollutions by nitrate leaching and the production of greenhouse gases such as nitrous oxide. To improve the agro-environmental balance of rapeseed, the use of biostimulants such as silicon (Si) constitutes an interesting alternative. In this context, the aim of our experiment was to study the effect of Si (a beneficial element for some plants especially to protect them against biotic and abiotic stress; Epstein, 1999) on vegetative growth, N uptake and leaf senescence progression of rapeseed subjected (or not) to N starvation.

**MATERIAL AND METHODS**

After germination on perlite, rapeseed seedlings were transferred for one week into a plastic tank containing nutrient solution with 1 mM N. Then, plants were separated into two batches: the first was supplied with the same nutrient solution with the addition of silicon (+Si: 1.7mM), and the second (-Si: 0.0 mM) was supplied with the nutrient solution only. After one week of Si pretreatment period, at day 0, each batch was again separated into two groups and grown during 12 days with (-Si+N ; +Si+N) or without N (-Si-N; +Si-N). Afterward, N-deprived plants have been re-supplied with N for 9 days (D21: -Si+rN; +Si+rN). At the end of Si pretreatment, plants were harvested for measurements of Si uptake (monitored by a colorimetric method), N uptake (determined with a continuous flow isotope mass spectrometer), and relative root expression of *BnaNRT1.1*, *BnaNRT2.1*, and *BnaAMT1.1* genes involved in nitrate (NRTs) and ammonium (AMT) uptake. Chlorophyll content and net photosynthetic activity were performed daily by a SPAD-502 chlorophyll meter and LI-COR, respectively, once the beginning of N starvation (day 0).

**RESULTS AND DISCUSSION**

Our study showed that rapeseed, which is considered a non-Si accumulator species (Hodson et al., 2005), is able to take up and store Si in roots at the end of the Si pretreatment (Fig. 1A). After a short period of Si treatment (7 days), the growth of +Si plants is increased by 1.45 fold compared to -Si plants (data not shown). This biomass increase is associated with an increase in the amount of N in +Si plants (Fig. 1B) and with induction (by 3 fold) of expression of the gene that encodes the *BnaNRT2.1* nitrate transporter (Fig. 1C).

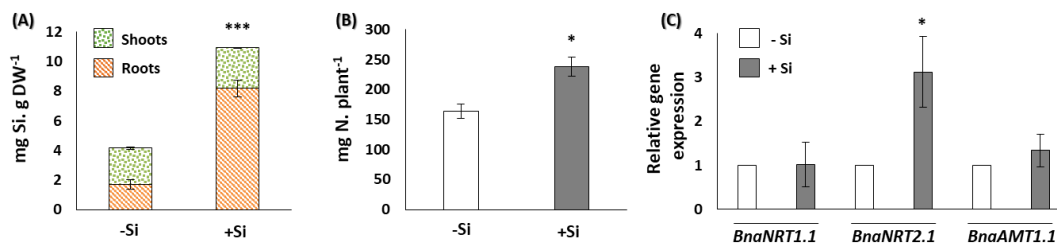

Figure 1. Silicon (Si) content (A), total nitrogen (N) amounts (B) and relative root expression of the *BnaNRT1.1*, *BnaNRT2.1*, and *BnaAMT1.1* genes (C) at the end of the Si pretreatment for rapeseed. Asterisks represent significant differences from the control at  $P < 0.05$  (\*),  $P < 0.001$  (\*\*\*)

Under N starvation (from day 0 to 12), this study has shown that from day 5 and 7 the leaf SPAD and net photosynthetic activity values of +Si plants were significantly higher than those of -Si plants (Figs. 2A and B). These two parameters are usually considered as physiological indicators of leaf senescence (Gombert et al., 2006), and our result suggest that a Si pretreatment induces a delay in leaf senescence in +Si plants submitted to N starvation compared to -Si plants. When N-deprived plants were resupplied with N (days 12 to 21), senescing mature leaves from +Si plants recovered net photosynthetic activity (Fig. 2B) and turned green again (Fig. 2A), while mature leaves from -Si plants continue to senesce and fall at day 16, confirming a reversal of leaf senescence progression only in plants pretreated with Si.

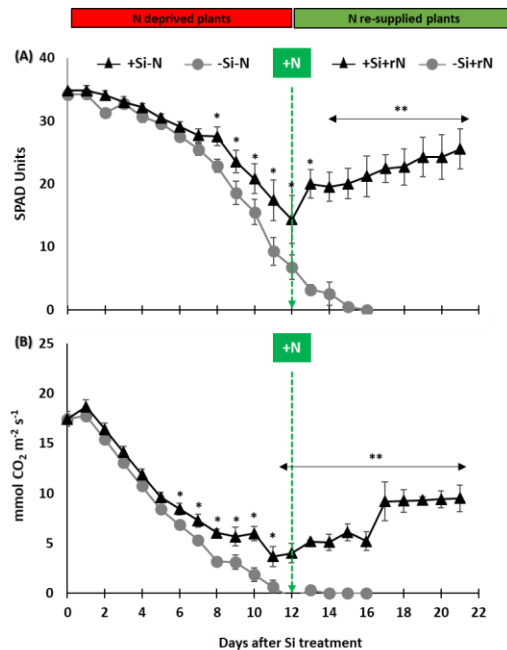

Figure 2. Change in SPAD values (A) and net photosynthetic activity (B) of mature leaf from rapeseed. Asterisks represent significant differences from the control at  $P < 0.05$  (\*),  $P < 0.01$  (\*\*).

## CONCLUSION

Si taken up by rapeseed improves biomass and increases N uptake and root expression of a nitrate transporter gene (*BnaNRT2.1*). In N-deprived plants, Si promotes a delay of leaf senescence allowing a better recovery of chlorophyll contents and photosynthetic activity when plant were re-supplied with N. Our study showed that Si is a beneficial element for rapeseed especially to cope to N deficiency by allowing it to increase leaf life span. Thus, Si may improve the agro-environmental balance of rapeseed by reducing the asynchronism between N remobilization from leaves and pods filling.

## REFERENCES

- Avicé JC., Etienne P., 2014. Leaf senescence and nitrogen remobilization efficiency in oilseed rape (*Brassica napus* L.). *Journal of Experimental Botany*. 65,3813-3824.
- Epstein E., 1999. Silicon. *Annual review of plant biology*. 50,641-664.
- Gombert J., Etienne P., Ourry A., Le Dily F. 2006. The expression patterns of *SAG12/Cab* genes reveal the spatial and temporal progression of leaf senescence in *Brassica napus* L. with sensitivity to the environment. *Journal of Experimental Botany*. 57,1949-1956.
- Hodson MJ., White PJ., Mead A., Broadley MR. 2005. Phylogenetic variation in the silicon composition of plants. *Annals of Botany*. 96(6):1027-46.

## TILLAGE, SIMULATED ANIMAL TREADING AND SOIL MOISTURE AFFECT DENITRIFICATION, NO<sub>3</sub> LEACHING, AND N<sub>2</sub>O AND N<sub>2</sub> EMISSIONS

THOMAS, S.M.<sup>1</sup>, FRASER, P.M.<sup>1</sup>, HU, W.<sup>1</sup>, CLOUGH, T.J.<sup>2</sup>

<sup>1</sup> Soil, Water and Environment Group, Plant & Food Research, New Zealand. <sup>2</sup> Department of Soil and Physical Sciences, Lincoln University, New Zealand

### INTRODUCTION

Nitrification, denitrification, nitrifier-denitrification are highly sensitive to soil oxygen concentration, a property that is temporally dynamic and highly spatially variable. Consequently, farming practices such as tillage and grazing, that modify soil structure, which controls aeration and gas exchange, will affect nitrogen transformations. How much tillage or grazing change soil structural properties largely depends on the loading, initial soil strength and soil wetness. In New Zealand pastoral systems, tillage is often used to establish crops that are later grazed *in situ* during winter when soils are wet. This practice is often used as part of pasture renovation or to supplement pasture feed. In dairy systems, this might occur on 10 % of the farm annually. Grazing of winter forage crops has been shown to increase emissions of nitrous oxide (N<sub>2</sub>O), an important greenhouse gas (Thomas et al., 2008). There is also evidence that nitrate (NO<sub>3</sub><sup>-</sup>) leaching losses may also be reduced following animal treading (Hill et al., 2015). Despite the potentially large environmental impacts and trade-offs associated with winter grazing of forage crops, there is a paucity of information about the effects of tillage, treading and wetness at time of treading and their influence on total denitrification, its products of N<sub>2</sub> and N<sub>2</sub>O, and the leaching of NO<sub>3</sub>.

### MATERIAL AND METHODS

We designed a replicated experiment using <sup>15</sup>N-enriched NO<sub>3</sub><sup>-</sup> to quantify how tillage (intensive cultivation vs. no-tillage), simulated treading (+/- compaction) and the soil moisture content at time of treading (<field capacity vs. > field capacity) affected gaseous losses of N<sub>2</sub>O and nitrogen (N<sub>2</sub>) and leaching losses of NO<sub>3</sub><sup>-</sup>. Intact soil lysimeters (30 cm diameter x 30 cm deep) were collected post-harvest from a tillage field trial conducted at Lincoln, Canterbury, New Zealand. The soil was a Templeton silt loam (USDA: Udic Ustochrept).

Treading was applied to the surface of the soil lysimeters (three hoof prints, 11 cm in diameter, per lysimeter; covering ~40% of soil surface area) at a pressure of 220 kPa using a hydraulic hoof simulator. Hanging fibreglass wicks applied soil water tensions (6 kPa) to the base of each lysimeter to simulate field conditions. Lysimeters were installed in a constant temperature room (14°C). <sup>15</sup>N- enriched (50 atom %) NO<sub>3</sub><sup>-</sup> solution was then applied to each lysimeter at a rate of 250 kg N ha<sup>-1</sup>. To simulate winter wetting and re-wetting conditions, 30 mm of water was applied weekly to the cores. Leachate volumes, NO<sub>3</sub><sup>-</sup> concentration, <sup>15</sup>N-enrichment of NO<sub>3</sub><sup>-</sup>, and drainage rates were determined following each watering. Soil surface gas fluxes were determined from gas samples collected from headspace chambers, collected daily for the first 4 weeks and three-times per week thereafter. Samples were analysed for N<sub>2</sub>O by gas chromatography, and <sup>15</sup>N<sub>2</sub>O and <sup>15</sup>N<sub>2</sub> enrichments by isotope ratio mass spectrometry. The experiment ran for 80 days after the <sup>15</sup>N was applied. Soil physical properties (bulk density, porosity, pore size distribution and hydraulic conductivity) were determined on additional cores at the start and mid-point of the experiment, and on the main experiment cores at the end of the experiment to improve understanding of how changes in soil physical properties affect the rates and products of denitrification, but are beyond the scope of this paper.

### RESULTS AND DISCUSSION

Treading when soils were wet (> field capacity) enhanced denitrification. More denitrification occurred from the mechanically weakened soil (intensively cultivated), compared to the more structurally intact no-till soil (Table 1). Nearly 30 % of the applied <sup>15</sup>N-enriched NO<sub>3</sub><sup>-</sup> was denitrified from the intensively tilled soil, compared to 18 %

from the no tilled soil. While most was lost as  $N_2$  from the intensive tilled soil, and the  $N_2O$  to total denitrification ratio was the lowest of all the treatments, it still produced the greatest amount of  $N_2O$  (3 % of the total N applied). Untrodden soils or soils trodden when the soil was drier had similar, lower amounts of denitrification (Table 1). Enhanced denitrification, removed a large amount of  $NO_3^-$ -N that might otherwise have leached. The intensively tilled soil, trodden when wet, lost c. 25% less  $NO_3^-$  in leachate than the treatments that were either uncompacted or trodden when drier (Table 1). Cumulative drainage amounts (c. 300 mm) and water applications depths (360 mm) over the experiment were similar for all treatments.

*Table 1. Cumulative  $NO_3^-$  leaching and gaseous losses via denitrification from lysimeters 80 days after  $^{15}N$  enriched  $NO_3^-$  was applied (@ 250 kg N ha<sup>-1</sup>). Simulated treading (Yes/No) was applied at two moisture contents (< or > Field capacity) to soils that had previously grown forage crops established with intensive or no-tillage cultivation.*

Tillage	Moisture at treading	Simulated treading	$NO_3^-$ leached kgN ha <sup>-1</sup>	Denitrification	
				$N_2$ emitted kgN ha <sup>-1</sup>	$N_2O$ emitted kgN ha <sup>-1</sup>
Intensive	Field capacity	No	146.7	24.7	5.5
	Field capacity	Yes	169.5	26.1	3.9
	Field capacity	Yes	112.4	64.4	8.2
No-Till	Field capacity	No	154.9	26.8	4.5
	Field capacity	Yes	150.8	30.0	6.9
	Field capacity	Yes	138.1	41.7	4.3

Removing  $NO_3^-$  that might leach could be considered an environmental benefit of enhanced denitrification, however other factors need to be considered. Firstly, much more  $N_2O$ , a potent greenhouse gas was produced where treading occurred under wet conditions. Secondly there was a loss of hydraulic conductivity (data not shown) which could lead to surface run off and soil erosion. From an agronomic perspective, the loss of soil  $NO_3^-$ -N is a loss for plant production and may need to be replaced by fertiliser inputs. Furthermore, severe soil damage can impact future crop production or might necessitate further soil amelioration before a new crop or pasture can be established.

## CONCLUSIONS

Large increases in denitrification and  $N_2O$  emissions are likely when soils are grazed when wet, especially when tillage is used to establish forage crops for grazing. Hence, grazing or using heavy machinery on wet, tilled soils should be avoided. Our results also demonstrate the need to consider the total environmental and agronomic consequences of increased denitrification, i.e. trade-offs between  $N_2O$  emission,  $NO_3^-$  leaching and future crop productivity. Further work is ongoing to understand how changes in soil physical condition (e.g. soil gas diffusivity) alter denitrification products, and how this information can be used to provide better soil management advice.

**Acknowledgements:** This work was funded from the Plant & Food Research Strategic Science Investment Fund and the MBIE Forages for Reduced Nitrate Leaching Programme.

## REFERENCES

- Hill AM., Di HJ., Cameron K., Podolyan A., 2015. The effect of animal trampling and DCD on ammonia oxidisers, nitrification, and nitrate leaching under simulated winter forage grazing conditions. *J Soils Sediments*, 15, 972-981
- Thomas SM., Beare MH., Francis GS., Barlow HE., Hedderley DI., 2008. Effects of tillage, simulated cattle grazing and soil moisture on  $N_2O$  emissions from a winter forage crop. *Plant Soil*, 309, 131-145

## **AN ORIGINAL EXPERIMENT TO DETERMINE IMPACT OF CATCH CROP INTRODUCTION IN A CROP ROTATION ON SOIL GREENHOUSE GAS EMISSIONS**

TALLEC, T.<sup>1</sup>, BOUSSAC, M.<sup>1</sup>, ZAWILSKI, B.<sup>1</sup>, CLAVERIE, N.<sup>1</sup>, BRUT, A.<sup>1</sup>, FERLICOQ, M.<sup>1</sup>, CESCHIA, E.<sup>1</sup>, MORDELET, P.<sup>1</sup>, LE DANTEC, V.<sup>1</sup>

<sup>1</sup> Centre d'Etudes Spatiales de la BIOsphère, UMR 5126 CNES/CNRS/IRD/UPS, 18 avenue Edouard Belin, 31401 Toulouse, France

### **INTRODUCTION**

One quarter of the global N<sub>2</sub>O emissions is emitted by agricultural soils. In cropland, long bare soil periods may occur between winter and summer crops with potentially large pools of nitrogen (N) available in the soil that can enhance N<sub>2</sub>O emissions. Cover crops have been shown to reduce N<sub>2</sub>O production during autumn by decreasing soil mineral N content (Thorup-Kristensen et al., 2003). However the impact of spring mineralization of incorporated cover crop on N<sub>2</sub>O production has been little studied and could possibly offset the positive effects observed in autumn (Kaye and Quemada, 2017). A unique paired-plot experiment was carried out in the South-West of France from September 2013 to July 2014 to determine the effect of catch crop introduction in a crop rotation on soil N<sub>2</sub>O and CO<sub>2</sub> fluxes (soil respiration, SR).

### **MATERIAL AND METHODS**

#### **Experimental site and design**

The study was carried out over the Lamasquère site (FR-Lam) near Toulouse. This plot belongs to a livestock farm and is part of the European research infrastructure consortium ICOS and of the Regional Spatial Observatory (OSR). The surface area of the plot is 23.8 ha and soil texture is clayey. The crop rotation is maize for silage/winter wheat, irrigated during the maize growing season. Straw is exported and the field receives both mineral and organic fertilisation. After winter wheat was grown in 2013, the plot was divided into two subplots (1<sup>st</sup> September 2013). One subplot was sown with white mustard, the other one remaining conventionally managed in bare soil (BS). Catch crop was incorporated into the soil after 3 months of growing (4 December 2013). Then both subplots followed the same management with maize seeded on 23 May 2014.

#### **Measurements of N<sub>2</sub>O and CO<sub>2</sub> fluxes**

Each subplot was equipped with a set of six steel automated chambers, coupled to two infrared gas analyzers (LI-820 for CO<sub>2</sub> mixing ratio measurement, Thermofisher 46i for N<sub>2</sub>O mixing ratio measurement). The automated chambers closed alternatively every 6 hours during 17.5 minutes each. Potential N<sub>2</sub>O and CO<sub>2</sub> accumulation were measured sequentially in each chamber every 10 seconds. To calculate the N<sub>2</sub>O fluxes the data were previously fitted with a rising exponential regression model. N<sub>2</sub>O fluxes were then calculated following Tallec et al. (accepted).

#### **Additional measurements**

Volumetric soil water content and temperature were monitored every hour at 0-7 cm depth inside each automated chamber (ML2x Thetaprobes, T107 thermistors). Water filled pore space (WFPS), that is a key variable for microbial activity and an indirect proxy of N<sub>2</sub>O production and diffusion was calculated. The soil nitrate (NO<sub>3</sub><sup>-</sup>) and ammonium (NH<sub>4</sub><sup>+</sup>) contents were measured monthly from September 2013 to July 2014. Vegetation dynamic (cover crop and maize) was also monitored for dry matter production and green area index.

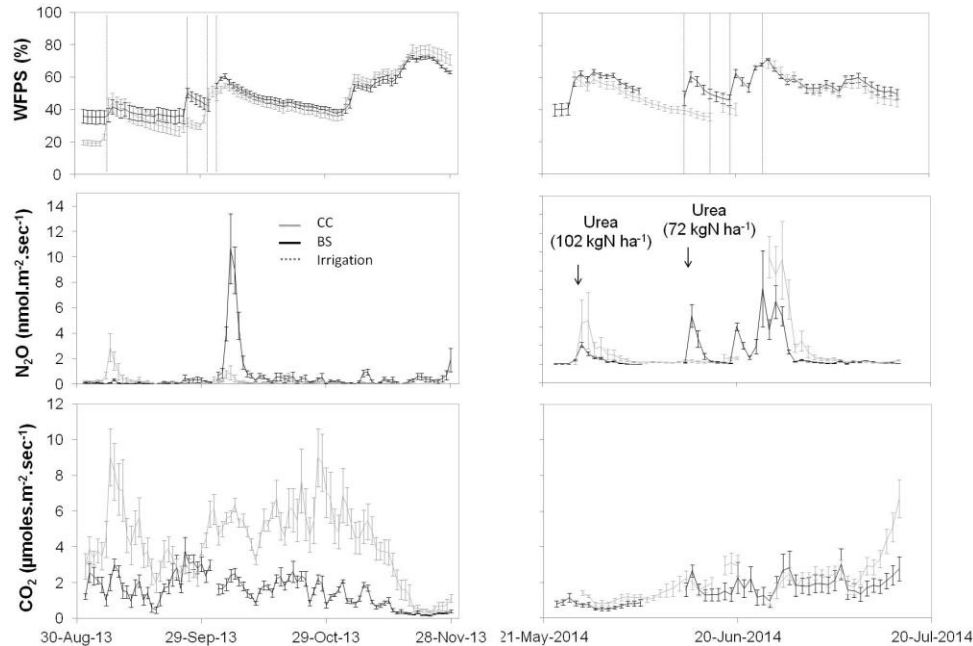

Figure 1: Daily dynamics of WFPS at 0-7cm depth, N<sub>2</sub>O and CO<sub>2</sub> fluxes according to the soil use (BS: Bare soil in black color, CC: Catch Crop in grey color). Error bars correspond to  $\pm$  the standard deviation of the mean.

## RESULTS AND DISCUSSION

During autumn (Figure 1), SR was positively related to the CC roots growing, causing a strong difference in SR between the two subplots. From the maximum level of CC development (data not shown), contribution of root respiration to the total SR was on average 56.5%. The nitrogen uptake from catch crop for its biomass production reduced soil mineral nitrogen content (data not shown). For similar WFPS (60%), lower soil mineral nitrogen content caused lower N<sub>2</sub>O emissions during autumn in the CC subplot than in the BS subplot.

In summer, with increasing temperature and similar WFPS (60%) in both subplots, significant higher N<sub>2</sub>O emissions occurred in the CC subplot compared to the BS one, particularly after N fertilizer inputs. The catch crop mineralization in addition to nitrogen fertilization significantly increased N<sub>2</sub>O emissions and soil respiration probably because of increased microbial activity. Moreover due to enhanced development of maize with higher N<sub>min</sub> availability, SR in the CC subplot was 1.38 to 1.83 time higher than SR measured in the BS subplot.

## CONCLUSION

Introduction of CC in a crop rotation is a promising way to reduce environmental footprint of crops by indirectly decreasing nitrogen leaching and N<sub>2</sub>O emissions during autumn and winter seasons. However our study underlined that those positive effects could be partly counteracted during the following growing season. N fertilization practices should also account for the net mineralization of the CC and the N requirements of the following crop to avoid enhance N<sub>2</sub>O emissions after the CC is incorporated in the soil. Next step is to evaluate N<sub>2</sub>O fluxes and Soil Respiration contribution to greenhouse gas budget over the whole crop year.

## REFERENCES

- Kaye, J. P., Quemada, M., 2017. Using cover crops to mitigate and adapt to climate change. A review. *Agron. Sustain. Dev.* 37:4, DOI: 10.1007/s13593-016-0410-x.
- Thorup-Kristensen et al., 2003. Catch crops and green manures as biological tools in nitrogen management in temperate zones. *Adv. Agronomy*, 79, 229-302.

## SUGARCANE TRASH REMOVAL REDUCES AMMONIA VOLATILIZATION AFTER SURFACE UREA APPLICATION

PINHEIRO, P. L.<sup>1</sup>, DIETRICH, G.<sup>1</sup>, RECOUS, S.<sup>2</sup>, GIOVELLI, R. L.<sup>1</sup>, SCHU, A. L.<sup>1</sup>, GIACOMINI, S. J.<sup>1</sup>

<sup>1</sup> Federal University of Santa Maria, Santa Maria, Brazil; <sup>2</sup> INRA - UMR FARE, Reims, France

### INTRODUCTION

In Brazil about 7.86 million hectares of sugarcane are managed in the green cane trash blanketing system (GCTB), in which trash (7.4 to 24.3 Mg ha<sup>-1</sup>) is left as mulch on the soil surface. About 60% of this straw is still present on the soil surface at the time of N application of the next sugarcane cycle. When urea is the source of N used and its application occurs on the surface of the straw, high N losses due to volatilization of ammonia (NH<sub>3</sub>) are expected (10 to 50% of applied urea-N). Recently, sugarcane straw has been used for other purposes such as energy generation or second generation ethanol. It is expected that total or partial removal of the crop straw will reduce urea-N losses by reducing favorable conditions for the NH<sub>3</sub> volatilization process (eg.: physical barrier reduction and decreased action of the urease enzyme). Thus, the objective of our work was to quantify the volatilization of NH<sub>3</sub> after the application of urea-N at different levels of straw removal after the sugarcane harvest.

### MATERIAL AND METHODS

The study was conducted at the Federal University of Santa Maria in the state of Rio Grande do Sul, Brazil. The experiment was carried out in the first ratoon sugarcane (RB95-6911) in 2016 and 2017. In each year, the experimental design was of randomized blocks in a factorial scheme 4x2 with four replicates. The first factor were four straw levels: 0, 4, 8 and 12 Mg ha<sup>-1</sup> (100, 67, 33 and 0% removal). The second factor were two rates of urea-N: 0 and 100 kg ha<sup>-1</sup>. The urea-N was applied in a single dose at 15/01 and 21/02 in 2016 and 2017, respectively, 52 and 60 days after sugarcane harvest.

The ammonia (NH<sub>3</sub>) volatilization was evaluated during 16 days in 2016 and 14 days in 2017, immediately following urea-N application. A semi-open static chamber collector, evaluated previously by Jantalia et al. (2012), was used to quantify the volatilized NH<sub>3</sub>. The volatilized NH<sub>3</sub> was collected in a polyurethane foam (0.017 g cm<sup>-3</sup>; 5 mm thick; 2.5 cm wide and 25 cm length) soaked in 50 mL of H<sub>2</sub>SO<sub>4</sub> (1 mol dm<sup>-3</sup>) + glycerol (4% v/v) acid solution. After each foam exchange, the chamber was changed place to minimize the effect of the chamber on the NH<sub>3</sub> volatilization process. The NH<sub>3</sub>-N contents were determined by distilling and titration. All data were submitted to analysis of variance (ANOVA) and the means of each treatment were compared by the LSD test at the 5% probability level. For the cumulative amount (quantity) of NH<sub>3</sub> at the different levels of straw a linear regression was fitted.

### RESULTS AND DISCUSSION

For the two years, NH<sub>3</sub>-N losses after application of urea-N was influenced by precipitation and amount of straw at the soil surface. In 2016, volatilization peaks of NH<sub>3</sub> occurred between day 10 and day 12 after N application after 5.2 mm of rainfall (Figure 1a). In 2017, maximum losses of NH<sub>3</sub>-N were observed in the first two days after application of N (Figure 1b), after precipitation of 11.5 mm. In both years, our results showed that higher amounts of straw on the soil surface favored higher NH<sub>3</sub>-N losses. We assume that the availability of water in the straw facilitates the solubilization of urea and increases the activity of the urease enzyme which determines the formation of NH<sub>3</sub> (Rochette et al., 2009). In addition, high amounts of straw on the soil surface can reduce or even prevent water infiltration into the soil (Vitti et al., 2007). Thus, the urea is retained in the straw and is susceptible to the action of the enzyme urease, which favors N losses by NH<sub>3</sub> volatilization. Therefore, there is a direct relationship between the amount of straw that remains on the soil and the loss of NH<sub>3</sub>-N (Table 1).

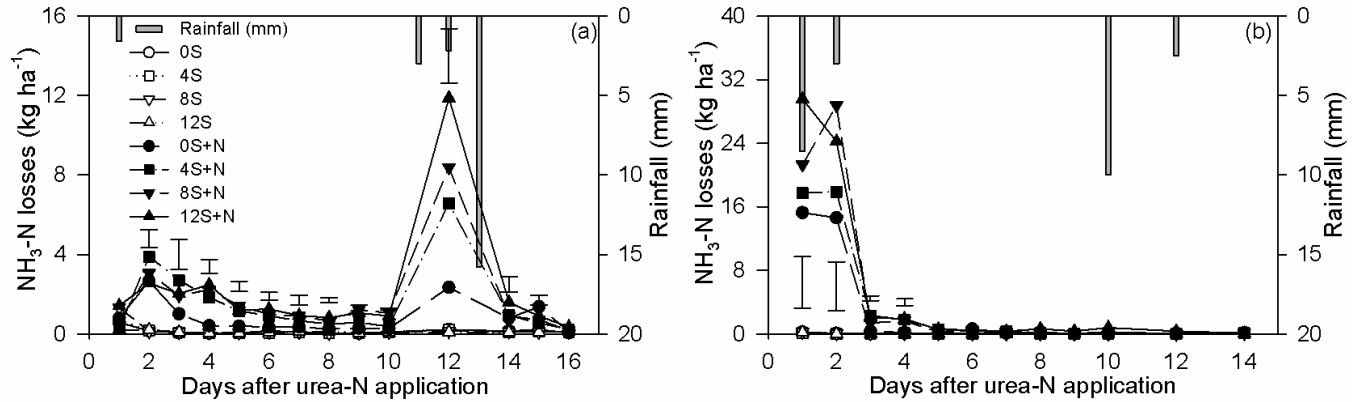

Figure 1. Rainfall and NH<sub>3</sub>-N losses in the first ratoon sugarcane in 2016 (a) and 2017 (b) after 100 kg urea-N ha<sup>-1</sup> (N) application over the different straw (S) rates (0, 4, 8 e 12 Mg ha<sup>-1</sup>). The vertical bar represents the least significant difference (LSD) between the treatments ( $p < 0.05$ ).

Table 1. Cumulative NH<sub>3</sub>-N emission in the first ratoon sugarcane (2016 and 2017) after 100 kg urea-N ha<sup>-1</sup> application over the different straw (S) rates (0, 4, 8 e 12 Mg ha<sup>-1</sup>). \*significant differ with t test ( $p < 0.05$ ).

Year	Straw level (Mg ha <sup>-1</sup> )				Regression
	0	4	8	12	
	NH <sub>3</sub> -N loss (% of N applied)				
2016	9.2	18.2	22.1	27.5	$y = 10.4479 + 1.4755 * x$ R <sup>2</sup> = 0.98
2017	30.7	40.8	53.7	60.8	$y = 31.0625 + 2.5821 * x$ R <sup>2</sup> = 0.99

## CONCLUSION

The removal of sugarcane straw on the soil reduces the losses of urea-N by ammonia volatilization in sugarcane cropping system. Every 4 Mg ha<sup>-1</sup> of straw removed from the crop, 8.1 kg of N ha<sup>-1</sup>, on average, are saved.

**Acknowledgements:** EMBRAPA-PETROBRAS, CAPES and CNPq.

## REFERENCES

- Jantalia C.P., Halvorson A.D., Follett R.F., Alves B.J. R., Polidoro J.C., Urquiaga S., 2012. Nitrogen source effects on ammonia volatilization as measured with semi-static chambers. *Agron. J.*, 104, 1595-1603.
- Rochette P., Angers D.A., Chantigny M.H., MacDonald J.D., Bissonnette N., Bertrand N., 2009. Ammonia volatilization following surface application of urea to tilled and no-till soils: A laboratory comparison. *Soil and Tillage Research*, 103, 310–315.
- Vitti A.C., Trivelin P.C.O., Gava G.J.D.C., Franco H.C.J., Bologna I.R., Faroni C.E., 2007. Produtividade da cana-de-açúcar relacionada à localização de adubos nitrogenados aplicados sobre os resíduos culturais em canavial sem queima. *Rev. Bras. Cienc. Solo*, 31, 491–498.



## EFFECT OF N APPLICATION RATE ON GROWING SEASON AND SPRING-THAW N<sub>2</sub>O EMISSIONS IN NORWEGIAN SPRING WHEAT

RUSSENE, A.L.<sup>1,2</sup>, KORSAETH, A<sup>1</sup>, BAKKEN, L.R.<sup>3</sup>, DÖRSCH, P.<sup>2</sup>

<sup>1</sup> Department of Agricultural Technology and System Analysis, Norwegian Institute of Bioeconomy Research, Norway; <sup>2</sup> Faculty of Environmental Sciences and Natural Resource Management, Norwegian University of Life Science, Norway; <sup>3</sup> Faculty of Chemistry, Biotechnology and Food Science, Norwegian University of Life Science, Norway.

### INTRODUCTION

N<sub>2</sub>O emissions from cultivated soils scale positively with the amount of N-fertilizer applied and may increase dramatically when the fertilization rate surpasses the N uptake by plants (Van Groenigen et al., 2010). It is therefore important to identify the N application rate which maximise yields while minimizing N<sub>2</sub>O-emissions. In cool-temperate climates, a large proportion of the annual N<sub>2</sub>O emission occurs, however, outside the cropping season, which potentially blurs the correlation between N input and N<sub>2</sub>O-N loss. For instance, in a recent study in SE Norway, we found a pronounced emission peak during snowmelt in spring wheat stubble (Russenes et al., 2016). To investigate whether winter emissions are affected by N-fertilization levels, we combined growing season and winter N<sub>2</sub>O emission data in a spring wheat plot trial with 0, 100, 140, 180 and 220 kg N.

### MATERIAL AND METHODS

The study was conducted in an ongoing plot trial with spring wheat (*Triticum aestivum* L.) in Southeast Norway. N levels varied from 100 to 220 kg N ha<sup>-1</sup>, with 40 kg intervals and zero-N controls (hereafter 100N, 140N, 180N, 220N and 0N). The plots were arranged randomly in two blocks (n=2). At sowing, all plots except 0N received 100 kg N ha<sup>-1</sup> as compound fertilizer. At the beginning of stem elongation (BBCH 31), 0, 40, 80 or 120 kg N ha<sup>-1</sup> were applied as top dressing. N<sub>2</sub>O emissions were monitored by closed chamber technique in duplicate in each plot from split fertilization to crop harvest, occasionally during winter (on top of the snowpack) and more intensively during spring thaw. Soil air was sampled throughout winter from tailor-made probes (Nadeem et al., 2012) installed at 20, 12.5 and 5 cm depth, as well as at the soil surface and 10 and 20 cm above the soil surface in the snowpack. Soil temperature and volumetric moisture content were measured continuously by sensors at 5 and 20 cm depth in one of the blocks. During the growing season, NO<sub>3</sub><sup>-</sup> and NH<sub>4</sub><sup>+</sup> content was determined on the date of flux sampling in each plot by extracting soil from 0 – 20 cm depth. Wheat yield was calculated and grain analyzed for grain moisture and protein. OneWay Anova and Fischer 95 % comparison of LSD, using Minitab® 17.2.1 were used to calculate differences between fertilizer levels.

### RESULTS AND DISCUSSION

In the growing season, N<sub>2</sub>O emission fluxes were largest on the day after top dressing, ranging from 14.6 - 95.8 µg N m<sup>-2</sup> h<sup>-1</sup>. Emission rates were greater, though not significantly, in treatments that had received additional N at stem elongation, and this difference persisted until 30 days after the split fertilization. A significantly higher flux was observed in the 220N treatment one week after top dressing (p = 0.023). Flux rates decreased gradually, until an increase in water filled pore space (WFPS) resulted in larger fluxes towards the end of the growing season. Here, emissions were significantly larger in 180N and 220N than in 100N and 140N, but there was no difference between 0N and 220N. Concentrations of extractable NO<sub>3</sub><sup>-</sup> and NH<sub>4</sub><sup>+</sup> matched the amount of added N, and gradually declined towards low levels at crop maturation. Cumulative N<sub>2</sub>O fluxes during the growing season increased with increasing N-addition showing significant differences between N fertilization levels (p=0,025). Emissions were significantly larger in 180N and 220N than in 0N or 100N. 140N did not differ significantly from other treatments. Together, our results indicate that there must be additional factors other than the amount of fertilizer N affecting N<sub>2</sub>O emissions during the growing season. N<sub>2</sub>O emission rates during winter (before spring-thaw; 24.6 to 54.0 µg N m<sup>-2</sup> h<sup>-1</sup>) were comparable in magnitude to those measured in the growing season. The

highest N<sub>2</sub>O emission rates were measured during spring thaw with rates more than double of those observed during the growing season (101.6 - 144.0 µg N m<sup>-1</sup> h<sup>-1</sup>). N<sub>2</sub>O emission rates during spring thaw did not differ significantly between N treatments. When cumulating the emissions, we found that spring thaw triggered substantial N<sub>2</sub>O emissions throughout the 20-days after onset of spring thaw. This suggests that a relatively large proportion of the annual emission occurs during a short period during spring thaw without any significant N-fertilization effect. Yield scaled emissions varied little between the N treatments (Tab. 1), but when scaled for grain yield, N<sub>2</sub>O emission were largest in non-fertilized plots, illustrating the importance of adjusting N fertilization for the uptake and utilization of N by plants as precise as possible. Throughout winter, N<sub>2</sub>O concentrations built gradually up under the snow cover in the wheat field. The soil temperature fluctuated around the freezing point both at 5 and 20 cm depth, with repeated freeze-thaw cycles (Fig. 1). When comparing the amounts accumulated to the cumulative emissions during thawing, only 6 % to 21.2 % of the emission was accounted for by release of accumulated N<sub>2</sub>O, indicating that N<sub>2</sub>O mostly is produced *de novo* during thawing.

Table 1 Cumulative N<sub>2</sub>O emissions (kg N ha<sup>-1</sup> period<sup>-1</sup>) for the different periods, grain yields (t ha<sup>-1</sup>) and emission intensity (kg N<sub>2</sub>O-N emitted per t grain ha<sup>-1</sup>). Different letters indicate significant differences between fertilization levels at p < 0.05.

Applied N kg ha <sup>-1</sup>	Cumulative kg N <sub>2</sub> O-N ha <sup>-1</sup>					Yield t grain ha <sup>-1</sup>	N <sub>2</sub> O intensity <sup>1</sup>	N <sub>2</sub> O intensity <sup>2</sup>
	Season 20.06- 30.08.11	Thawing 08.03- 27.03.12	Winter/Thawing 02.12.11-27.03.12	Season+ Winter/Thawing				
	0.26 ± 0.09 <sup>a</sup>	0.34 ± 0.04	0.67 ± 0.16 <sup>a</sup>	0.93 ± 0.29 <sup>a</sup>	2.26 ± 0.74 <sup>a</sup>	0.117	0.412	
100	0.26 ± 0.08 <sup>a</sup>	0.31 ± 0.16	0.76 ± 0.09 <sup>a</sup>	1.02 ± 0.33 <sup>ab</sup>	5.81 ± 0.38 <sup>b</sup>	0.045	0.175	
140	0.41 ± 0.09 <sup>ab</sup>	0.34 ± 0.19	0.84 ± 0.11 <sup>ab</sup>	1.25 ± 0.39 <sup>bc</sup>	6.70 ± 0.40 <sup>b</sup>	0.061	0.186	
180	0.48 ± 0.12 <sup>b</sup>	0.44 ± 0.07	0.74 ± 0.13 <sup>a</sup>	1.22 ± 0.32 <sup>abc</sup>	7.42 ± 0.31 <sup>b</sup>	0.065	0.164	
220	0.45 ± 0.12 <sup>b</sup>	0.35 ± 0.16	1.01 ± 0.21 <sup>b</sup>	1.46 ± 0.49 <sup>c</sup>	7.01 ± 0.47 <sup>b</sup>	0.064	0.208	

<sup>1</sup>growing season emission relative to grain yield, <sup>2</sup>total emission (growing season+winter/thawing) relative to grain yield

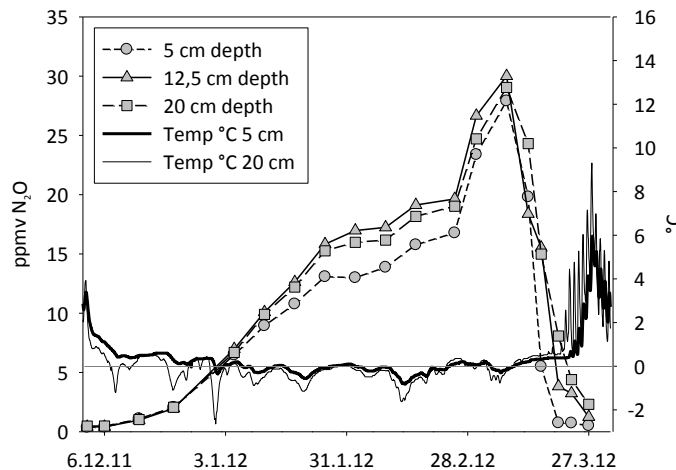

Figure 1. Accumulation of N<sub>2</sub>O throughout winter in three soil depths and soil temperatures 5 and 20 cm.

## CONCLUSION

N<sub>2</sub>O emissions during growing season are positively related to the amount of N added by split application, but when scaled to grain yield, the differences are minimal apart from the higher emissions found in unfertilized plots. To minimize the environmental impact while securing high yield output, it is therefore important to adjust N fertilizer levels to the actual crop production. N<sub>2</sub>O production and emission during winter and spring thaw do not seem to be affected by N fertilization applied in the growing season. Subnivean N<sub>2</sub>O accumulation throughout winter contributed less than 20 % to spring-thaw emissions, indicating that *de novo* production is the main source of N<sub>2</sub>O emission during spring thaw.

## REFERENCES

Nadeem, S., Hansen, S., Bleken, M.A., Dörsch, P., 2012. N<sub>2</sub>O emission from organic barley cultivation as affected by green manure management. *Biogeosciences Discussions* 9, 2307-2341.

# 20<sup>th</sup> Nitrogen Workshop

## Coupling C-N-P-S cycles

June 25-27, 2018  
Le Couvent des Jacobins, Rennes – France

### **Session III: Local process studies – Highlighted posters**

## PROTEIN AND AMINO ACID BREAKDOWN IN SOIL ALONG A PLANT FERTILITY GRADIENT

GREENFIELD, L.M.<sup>1</sup>, HILL, P.W.<sup>1</sup>, PATERSON, E.<sup>2</sup>, BAGGS, E.M.<sup>3</sup>, SEATON, F.M.<sup>4</sup>, JONES, D.L.<sup>1</sup>

<sup>1</sup> Bangor University, UK; <sup>2</sup> James Hutton Institute, UK; <sup>3</sup> University of Edinburgh, UK; <sup>4</sup> Centre for Ecology & Hydrology, UK

### INTRODUCTION

Soil organic compounds (including proteins and amino acids) are important sources of carbon (C) and nitrogen (N) for microorganisms. Therefore, the breakdown of proteins and amino acids in soil represent key controls on both the soil C and N cycles. Protease enzymes break down proteins to peptides and amino acids in the rate limiting step of organic N mineralisation whereas free amino acids can be taken up directly by microorganisms. Soil organic compound quantity is determined by plant production and decomposition of plant-derived material (Jobbagy and Jackson 2000). Consequently, the relationship between plant fertility and protein and amino acid breakdown is important in understanding the controls on soil C and N cycling.

### MATERIAL AND METHODS

We investigated how soil properties affect protein and amino acid breakdown along a fertility gradient. Soil was collected at two depths at ten points along a UK catena sequence. The catena sequence is a series from sea level to 410 m elevation characterised by different soil types and grassland communities. Background soil and plant parameters were measured at each site including soil protease activity following the method by Vepsäläinen et al., (2001). Rates of protein and amino acid mineralisation were measured by adding <sup>14</sup>C-labelled plant protein and a <sup>14</sup>C-labelled amino acid mixture respectively. Then <sup>14</sup>CO<sub>2</sub> evolution was measured over a two-month period. A conceptual framework of protein and amino acid mineralisation along a plant C:N gradient was created to determine the key soil parameters that influence mineralisation.

All statistical analyses were performed in R studio 1.1.0.153 (R Core Team 2017). A random effects model was created to test the conceptual framework of protein and amino acid mineralisation along a plant C:N gradient. A model was fitted for <sup>14</sup>CO<sub>2</sub> production after 6 hours and 60 days from <sup>14</sup>C-labelled protein and amino acid at each depth with site as a random effect using the lme function in the package nlme (Pinheiro and al. 2017).

### RESULTS AND DISCUSSION

Overall, <sup>14</sup>CO<sub>2</sub> production from <sup>14</sup>C-labelled protein occurred at higher rates in the topsoil compared to the subsoil but no difference was observed between depths for amino acids (Fig. 1). Input of soil organic compounds are expected to be higher in the topsoil compared to the subsoil due to a higher density of roots that release organic compounds. This leads to a high abundance of microorganisms resulting in increased soil organic C mineralisation rates (Loeppmann et al. 2016). Therefore, it is unexpected that amino acid mineralisation does not differ between depths. <sup>14</sup>CO<sub>2</sub> production from <sup>14</sup>C-labelled amino acid was higher in the first six hours compared to <sup>14</sup>C-labelled protein (Fig. 1) indicating that amino acids were utilised more quickly because they can be taken up intact by microorganisms.

According to our model, soil C and N, and microbial biomass C were found to have the most effect on <sup>14</sup>CO<sub>2</sub> production. As above, these results show that soil organic compound inputs and microbial hotspots around the roots are important drivers on mineralisation rates. Plant C:N ratio was also an important control on protein and amino acid mineralisation rates indicating that breakdown is correlated with the plant fertility gradient. Protease activity did not have a strong influence on C mineralisation likely because proteases were not a limiting factor.

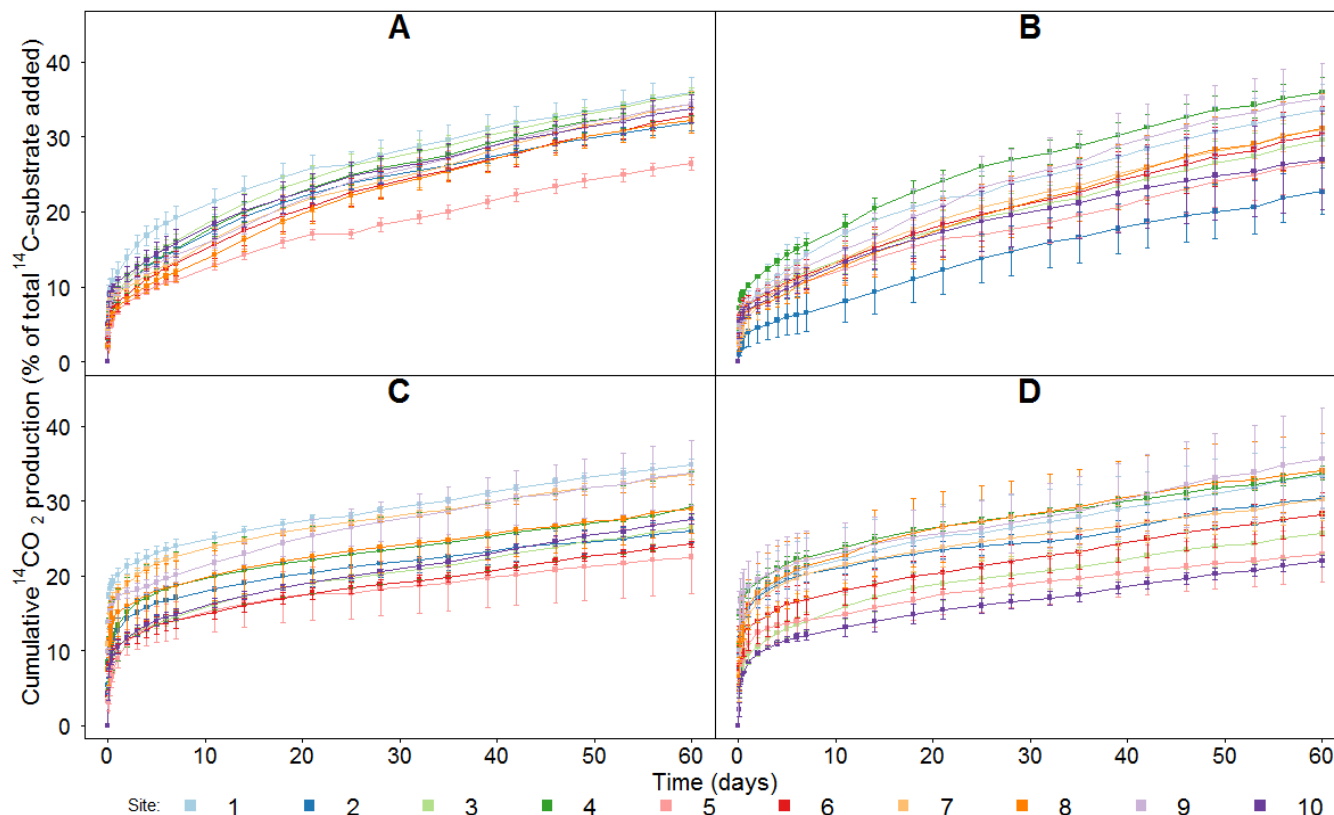

Figure 1. Cumulative  $^{14}\text{CO}_2$  production (% of total  $^{14}\text{C}$ -substrate added) ( $n = 3$ ; mean  $\pm$  SEM) for each site from low plant C:N ratio (site 1) to high plant C:N ratio (site 10) over a 60 day period. A)  $^{14}\text{C}$ -labelled protein added to topsoil, B)  $^{14}\text{C}$ -labelled protein added to subsoil, C)  $^{14}\text{C}$ -labelled amino acids added to topsoil and D)  $^{14}\text{C}$ -labelled amino acids added to subsoil.

## CONCLUSION

Our study indicates that soil C and N inputs and microbial biomass are stronger drivers on soil organic C mineralisation over the plant fertility gradient rather than soil protease activity.

**Acknowledgements:** This work was supported by the Biotechnology and Biological Sciences Research Council; and the Natural Environment Research Council [Grant number NE/M009106/1], by a Soils Training and Research Studentships (STARS) grant to LMG. STARS is a consortium consisting of Bangor University, British Geological Survey, Centre for Ecology and Hydrology, Cranfield University, James Hutton Institute, Lancaster University, Rothamsted Research and the University of Nottingham.

## REFERENCES

- Jobbágy EG, Jackson RB (2000) The vertical distribution of soil organic carbon and its relation to climate and vegetation. *Ecol Appl* 10:423–436
- Loeppmann S, Blagodatskaya E, Pausch J, Kuzyakov Y (2016) Enzyme properties down the soil profile - A matter of substrate quality in rhizosphere and detritosphere. *Soil Biol Biochem* 103:274–283
- Pinheiro J, Bates D, DebRoy S, et al (2017) nlme: Linear and Nonlinear Mixed Effects Models. (R package version 3.1-131)
- R Core Team (2017) R: A language and environment for statistical computing
- Vepsäläinen M, Kukkonen S, Vestberg M, et al (2001) Application of soil enzyme activity test kit in a field experiment. *Soil Biol Biochem* 33:1665–167

## HOW DO SOIL AND FERTILISER TYPE AFFECT N<sub>2</sub>O AND N<sub>2</sub> FLUXES? A SHORT-TERM HELIUM OXYGEN INCUBATION EXPERIMENT

BUCHEN, C.<sup>1</sup>, HAGEMANN, U.<sup>1</sup>, AUGUSTIN J.<sup>1</sup>

<sup>1</sup> Leibniz Centre for Agricultural Landscape Research (ZALF), Germany

### INTRODUCTION

The greenhouse gas nitrous oxide (N<sub>2</sub>O) is mainly derived from agricultural soils, whereby high fertiliser inputs are directly related to N<sub>2</sub>O production. Understanding the factors controlling N<sub>2</sub>O production processes in soils is still challenging and has to be improved to implement more advanced mitigation strategies to reduce undesirable side effects of fertiliser use. During the last years, a large share of mineral fertiliser was substituted by biogas residues (BD) from biogas production. However, BD have a higher potential to increase N<sub>2</sub>O fluxes due to increasing ammonium (NH<sub>4</sub><sup>+</sup>-N) concentrations and total nitrogen (N<sub>t</sub>) contents, as well as the labile carbon (C) pool in soil, compared to mineral fertilisers (MIN) (*e.g.* ammonium sulphate) (Senbayram et al., 2009; Charles et al., 2017). Apart from N<sub>2</sub>O fluxes, the question have to be raised, how much of the applied fertiliser N is lost via dinitrogen (N<sub>2</sub>) fluxes, which is of agronomic interest. Up to now, there are only a few data about N<sub>2</sub> fluxes following BD application. That's most likely, because determination of N<sub>2</sub> fluxes from soils is still a delicate matter due to high atmospheric background concentrations. In addition, environmental controls, such as nutrient and oxygen availability, soil conditions and climate have a known impact on N<sub>2</sub>O and N<sub>2</sub> fluxes. Therefore it is required to improve our understanding of the combined effects of the factors mentioned on the resulting N<sub>2</sub>O/(N<sub>2</sub>O+N<sub>2</sub>) ratio of denitrification. Thus, two fertiliser types (BD vs. MIN) and five different soil types (ranging from slightly loamy sand to very clayey silt) were investigated in a short-term laboratory experiment under N<sub>2</sub> free helium-oxygen (He-O<sub>2</sub>) incubation atmosphere.

### MATERIAL AND METHODS

#### Field sampling

Five undisturbed soil cores (250 cm<sup>3</sup>) were randomly taken immediately after fertiliser application in spring from five different study sites, covering various soil characteristics along a broad range of weather conditions in Germany. On all sites, two types of fertiliser were previously applied using drag hose and injection techniques: organic fertiliser, *i.e.* BD from biogas plants and MIN fertiliser, *i.e.* calcium ammonium nitrate.

#### Laboratory incubation

Soil cores were incubated in special gas-tight incubation vessels in a He-O<sub>2</sub> incubation system (Butterbach-Bahl et al., 2002), classified as a flow-through steady-state system. Incubation atmosphere was replaced with He gas mixture containing <21 % O<sub>2</sub> and trace gases to remove atmospheric N<sub>2</sub>. An incubation temperature of 10°C was established, similar to prevailing field conditions during sampling. Simultaneous measurements of the gases: N<sub>2</sub>O and N<sub>2</sub> were conducted, lasting for two to four days until fluxes were constant. Following incubation, soil samples were analysed on relevant soil parameters (*e.g.* WFPS, NO<sub>3</sub><sup>-</sup>, NH<sub>4</sub><sup>+</sup>, pH, C<sub>org</sub>, N<sub>t</sub>).

#### Data analysis

Differences in soil properties and gas fluxes between treatments within site were analysed using the Mann-Whitney U-Test; differences among sites within treatments using the Kruskal-Wallis *H*-Test combined with *post-hoc* Student-Newman-Keuls test. Pairwise associations between either N<sub>2</sub>, N<sub>2</sub>O, N<sub>2</sub>O/(N<sub>2</sub>O+N<sub>2</sub>) ratio of denitrification, soil and fertilisation parameters were characterised using the distribution-independent coefficient Spearman's rho. The influence of all variables on N<sub>2</sub> and N<sub>2</sub>O fluxes was determined using generalised linear model (GLM) analysis with stepwise elimination.

## RESULTS AND DISCUSSION

### Site characteristics

Organic BD applications increased differences and variability among sites due to higher pH values, higher soil moisture (WFPS: 31 to 75%), higher organic C concentrations, higher  $\text{NH}_4^+$  and lower  $\text{NO}_3^-$  concentrations in BD samples compared to MIN samples.

### $\text{N}_2\text{O}$ and $\text{N}_2$ fluxes

Measured absolute  $\text{N}_2\text{O}$  fluxes ranged from 37 to 1221  $\mu\text{g N}_2\text{O-N m}^{-2} \text{ h}^{-1}$  and from 23 to 140  $\mu\text{g N}_2\text{O-N m}^{-2} \text{ h}^{-1}$  for BD and MIN soil samples. Across sites, BD samples showed both significantly higher absolute and relative (to fertiliser N input)  $\text{N}_2\text{O}$  fluxes compared to MIN samples, even though this effect was dominated by samples from clayey Dornburg site. The same applies for the  $\text{N}_2$  fluxes, where all measured fluxes were higher from BD samples than MIN samples. This means that the calculated average  $\text{N}_2\text{O}/(\text{N}_2\text{O}+\text{N}_2)$  ratio of denitrification was lower for BD compared to MIN samples, even though  $\text{N}_2$  fluxes dominated both fertiliser treatments.

### Environmental controls

GLM analysis showed  $\text{NH}_4^+\text{-N}$  concentration, study site, bulk density, soil moisture and their interactions to be the most important factor for  $\text{N}_2\text{O}$  fluxes, followed by application type and fertilisation treatment. However,  $\text{N}_2$  fluxes were driven by fertilisation treatment,  $\text{NH}_4^+\text{-N}$  concentrations and their interactions, followed by soil moisture and application type.

## CONCLUSION

The present study provided valuable insights into short-term  $\text{N}_2\text{O}$  and  $\text{N}_2$  fluxes following the initial phase of fertiliser application. In particular high N losses from soil were obtained for the BD treatment, which were lost as a valuable plant nutrient source. Overall,  $\text{N}_2\text{O}$  and  $\text{N}_2$  fluxes were strongly influenced by the interactions between soil and fertiliser type along five different field sites across Germany.

**Acknowledgements:** The study was funded by the German Federal Ministry of Food and Agriculture and managed by the Agency for Renewable Resources under grants 22021008 (08NR210). We thank all our partners from the Christian-Albrechts-University Kiel, University of Rostock, University of Applied Sciences Weihenstephan-Triesdorf, Thünen Institute and the Leibniz Centre for Agricultural Landscape Research.

## REFERENCES

- Butterbach-Bahl, K., Willibald, G., Papen, H., 2002. Soil core method for direct simultaneous determination of  $\text{N}_2$  and  $\text{N}_2\text{O}$  emissions from forest soils. *Plant and Soil* 240, 105-116.
- Charles, A., Rochette, P., Whalen, J., Angers, D., Chantigny, M., Bertrand, N., 2017. Global nitrous oxide emission factors from agricultural soils after addition of organic amendments: A meta-analysis. *Agriculture, Ecosystems & Environment* 236, 88-98.
- Senbayram, M., Chen, R., Mühling, K., Dittert, K., 2009. Contribution of nitrification and denitrification to nitrous oxide emissions from soils after application of biogas waste and other fertilizers. *Rapid Communications in Mass Spectrometry* 23, 2489-2498.



## INTERACTIVE PLANT AND SOIL EFFECTS ON DENITRIFICATION POTENTIAL IN AGRICULTURAL SOILS

MALIQUE F.<sup>1</sup>, KE P.<sup>2</sup>, MAURER D.<sup>3</sup>, DANNENMANN M.<sup>1</sup>, BUTTERBACH-BAHL K.<sup>1</sup>

<sup>1</sup> Institute for Meteorology and Climate Research, Atmospheric Environmental Research (IMK-IFU), Karlsruhe Institute of Technology (KIT), Garmisch-Partenkirchen 82467, Germany, <sup>2</sup> State Key Laboratory of Environmental Simulation and Pollution Control, Tsinghua University, Beijing 100084, China, <sup>3</sup> Institute of Forest Botany and Tree Physiology, Albert-Ludwig University, 79085 Freiburg

### INTRODUCTION

During microbial denitrification, nitrate ( $\text{NO}_3^-$ ) is reduced to nitrite ( $\text{NO}_2^-$ ), nitric oxide (NO), nitrous oxide ( $\text{N}_2\text{O}$ ) and finally to the terminal end product dinitrogen ( $\text{N}_2$ ). The main ecological importance of denitrification is the removal of reactive nitrogen (N) from the biosphere. Moreover, denitrification is a key process for the production and consumption of the potent greenhouse gas  $\text{N}_2\text{O}$ . Main controls of denitrification are carbon and nitrate availability as well as oxygen levels as denitrification is a predominantly anaerobic process. All major controls of denitrification are directly or indirectly affected by plants. However, the effects of plants on denitrification as well as plant-soil interactions in dependence of soil parameters (texture, SOC) have rarely been studied.

Here we investigated the effect of three common agricultural crops (wheat, barley and ryegrass) on the denitrification potential in two different agricultural soils.

### MATERIAL AND METHODS

Two different soils were collected in Germany during the summer 2016: a) the Rotthalmünster soil was taken from arable land at the long-term experimental field in Höhere Landbauschule Rottalmünster (latitude  $\text{N}48^\circ21'$ , longitude  $\text{E}13^\circ11'$ , elevation 360m above sea level (a.s.l.); b) the Gießen soil, was taken at the grassland research station (latitude  $\text{N}50^\circ32'$ , longitude  $\text{E}8^\circ41.3'$ , elevation 172m a.s.l.) near Gießen in the floodplain of the stream Lückenbach. The soils were sieved (10mm), air-dried and finally stored at  $4^\circ\text{C}$  before use. Experiments were done with three crops: wheat (*Triticum aestivum*), barley (*Hordeum vulgare*), and ryegrass (*Lolium multiflorum*).

Plants were pre-germinated on a 1% agar-agar solution. Following germination, plants were transplanted in planting pots (1L volume) with soils either originating from Gießen or Rotthalmünster. Soils were either fertilized (all plant treatments (3 crop types + 1 unplanted control)) with 100 mg N/kg dry soil of NPK fertilizer or left unfertilized (barley crops and unplanted control). Throughout the experiments soil moisture content was kept constant at a) 50 % Water Filled Pore Space (WFPS) (Rotthalmünster and Giessen) or b) at 34% (Rotthalmünster) or c) 40% WFPS (Giessen).

Besides planted soil we also investigated unplanted soils as controls. Soil denitrification potentials were measured before plant transplanting (day 0) and 10, 30 and 50 days after plant transplanting. The multifactorial experiment (2 soils \* 4 plant treatments \* 2 water levels \* 2 fertilizer levels (unfertilized/ fertilized)) was replicated 5 times for the four sampling dates (day 0, 10, 30 and 50 following transplanting), resulting in a total of 480 planted/unplanted pots.

At sampling dates soil and plants were carefully separated, with soils being separated, as far as possible, in bulk and rhizosphere soil. Root and shoot biomasses were measured. Soils samples were analyzed for nitrate and ammonium contents, and soil denitrification potential.

The soil denitrification potential of bulk and rhizosphere soil was measured according to the protocol given by Groffman et al. (1999) using the acetylene blockage technique. Gas samples were analysed for  $\text{N}_2\text{O}$  with a SRI 8610C Gas Chromatograph equipped with an electron capture detector. Potential denitrification rates were calculated from the mass of  $\text{N}_2\text{O}$  produced during 1-hour anaerobic incubation (ng N/g/h). The results were

statistically compared by using either the one-way ANOVA and Tukey's-b post hoc test method for the samples which meet the requirements, or the non-parametric Welch and Games-Howell post hoc test method.

## RESULTS AND DISCUSSION

At none of the sampling dates significant differences in potential denitrification rates could be demonstrated for treatments with and without fertilizer. Increased rates of potential denitrification in rhizosphere soils were found for soil samples taken at day 10 following transplanting, while for 30 and 50 no distinction could be made between bulk and rhizosphere soils as the entire planting pot was densely rooted. The following results are therefore only for fertilized pots and rhizosphere soil samples.

Rates of potential denitrification were significantly and up to 7 times higher in early plant growth stages (0 and 10 days) –as compared to soils sampled at days 30 and 50. Denitrification potentials significantly differed between the two soil types only for samples taken at days 0 and 10. (Figure 1). Across the entire observation period and all sampling dates significant differences in potential denitrification between unplanted and planted soils were not found.

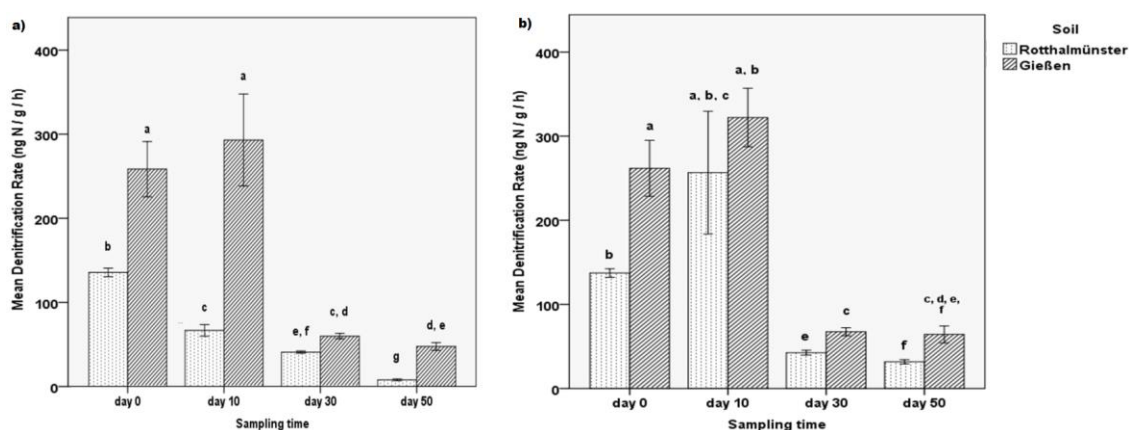

Figure 1. Comparison of denitrification potential of fertilized soils taken either from Gießen (grassland soil) or Rotthalmünster (arable soil) with soils being incubated at 50% WFPS. Figure a) shows results for unplanted pots, while figure b) shows results for pots planted with wheat. Different letters indicate a significant difference at  $p < 0.05$

However, interactive effects of plants and soils on denitrification potential were found for individual sampling dates. These effects were either of additive, synergistic or antagonistic nature.

## CONCLUSION

In sum, our results underline the decisive but so far hardly quantified importance of plants for the denitrification activity in soils. In order to provide a holistic understanding of plant control on denitrification, future studies should focus on disentangling plant-soil-microbe effects on actual denitrification rates and N gas product ratios. However, this remains a methodological challenge. Further analyses of soil properties and plant traits might be critical to better understand the mechanisms of how plants do effect soil denitrification.

## REFERENCES

- Groffman P. M., Gold A. J., Addy K., 1999. Nitrous oxide production in riparian zones and its importance to national emission inventories. *Chemosphere – Global Change Science* 2, 291-299

## NITROGEN LEACHING AND NITROUS OXIDE EMISSIONS FROM MAIZE: MITIGATION POTENTIAL OF VIZURA®, A NOVEL FORMULATION OF 3,4-DIMETHYLPYRAZOLE PHOSPHATE (DMPP)

NAIR, D.<sup>1</sup>, SANZ-GOMEZ, J.<sup>2</sup>, BRENDSTRUP, I.<sup>3</sup>, PETERSEN, S.O.<sup>1</sup>

<sup>1</sup> Department of Agroecology, Aarhus University, Denmark; <sup>2</sup> BASF SE, Germany; <sup>3</sup> BASF A/S, Denmark

### INTRODUCTION

Denmark is an intensively farmed country, with 61% of its total land under cultivation. In the year 2015, agriculture contributed to 21.5% of the total greenhouse gas emissions in Denmark (Nielsen et al., 2017). Since Denmark has a 39% emission reduction target for 2030 as per the European Union's climate and energy framework for non-ETS sectors (Denmarks Energy and Climate Outlook, 2017), significant mitigation needs to be achieved also by the agriculture sector.

Silage maize for dairy cattle feed has become an important crop in Denmark, and the area under silage maize cultivation has increased from 61,000 to 190,000 ha during the past 20 years, often in rotations with grass-clover as the preceding crop. It is well established that mineral N accumulating in the soil after harvest of maize represents a risk of NO<sub>3</sub><sup>-</sup> leaching during winter (Hansen & Eriksen, 2016). However, grass-clover incorporated before planting of maize can return large quantities of organic N to the soil (Eriksen, 2001) and net N mineralisation during spring, before planting of maize, therefore also involves a risk of nitrate leaching depending on soil properties and rainfall patterns.

Nitrification inhibitors have the potential to reduce N<sub>2</sub>O emissions, as well as nitrate leaching from manure and fertilizer amended croplands (Qiao et al., 2015) by suppressing the activity of nitrifying bacteria and possibly archaea, thereby delaying the conversion of NH<sub>4</sub><sup>+</sup> to NO<sub>3</sub><sup>-</sup>. This reduces the potential for N<sub>2</sub>O emissions from nitrification, and from denitrification, by reducing substrate availability for denitrifying microbes. Use of NI's can thus help retain N in the form of less mobile NH<sub>4</sub><sup>+</sup> and potentially improve plant N use efficiency. BASF has developed Vizura®, a novel formulation of the nitrification inhibitor DMPP for liquid manure and biogas digestate. In this study, Vizura® was assessed for its potential to mitigate N<sub>2</sub>O emissions and nitrate leaching from a coarse sandy soil during spring within a grass-clover and maize rotation receiving cattle manure.

### MATERIALS AND METHODS

The experiment was carried out in a lysimeter facility located at AU Campus Foulum in western Denmark. A total of 36 lysimeters (1 m x 1 m, depth 1.4 m) with coarse sandy soil had been seeded with grass-clover (GC) in June 2016. A total of 12 treatments with three replicates were planned in a factorial design with three factors (figure 1), including: 1) ± application of Vizura® to GC prior to incorporation; 2) application of cattle manure ± Vizura® or no fertilization; and 3) ± simulated rain events to represent wet spring conditions; the pattern of extra rainfall (in total 90 mm) was determined based on precipitation in previous years. The treatments were randomized within each of three blocks.



Figure 1: Treatment combinations

During April 2017, GC was cut and returned in equal amounts to all lysimeters, half of the portions after treatment with Vizura<sup>®</sup>, and then spring tillage was simulated. Manure or manure + Vizura<sup>®</sup> was applied to and incorporated in the respective plots, followed the next day by sowing of silage maize in all plots, in two rows with five plants each.

Monitoring of N leaching and N<sub>2</sub>O emissions began in April 2017, immediately after GC tillage. Leachate was collected from all lysimeters for analysis of NO<sub>3</sub><sup>-</sup> concentrations and volumes of leachate. Nitrous oxide emissions were determined by a closed static chamber method from an area between the two rows of maize plants. As supporting data, soil air was sampled from diffusion probes inserted at 5, 10, 20 and 50 cm depth in connection with flux measurements. Weather data were obtained from a nearby weather station. Crop yield was determined at harvest.

## RESULTS AND DISCUSSION

Monitoring of N<sub>2</sub>O emissions and nitrate leaching covered a 12-month period, and therefore final cumulative values were not available at the time of writing. The preliminary estimates of N<sub>2</sub>O emissions, including measurements from April to September, showed a consistent reduction in treatments where manure was amended with Vizura<sup>®</sup> in comparison to control treatments. An effect of treating GC with Vizura<sup>®</sup> before tillage was only seen under high rainfall conditions.

With respect to leaching, elevated nitrate concentrations in leachates (collected at 1.4 m depth) were not observed until August. The delay would be consistent with matrix flow of pore water in the coarse sandy soil. Based on the preliminary data representing April to September, there was no effect of Vizura<sup>®</sup> on nitrate leaching under normal rainfall conditions. The simulated high rainfall significantly increased leaching losses from treatments with un-amended manure, but this increase in nitrate leaching was partly prevented in manure + Vizura<sup>®</sup> treatments, showing a potential to conserve plant available N under wet spring conditions.

Harvest yield data were not available at the time of writing. Based on fresh weights only, the harvested biomass was substantially reduced under high rainfall conditions, but the yield reduction was less pronounced in treatments with Vizura<sup>®</sup>.

The preliminary results from this study thus indicate that nitrification inhibitors such as Vizura<sup>®</sup>, applied along with manure, could be a viable option for farmers to reduce N<sub>2</sub>O emissions, as well as nitrate leaching on sandy soils. For Denmark, it could help in achieving the emission reduction target for agriculture of 39%.

## REFERENCES

- Denmarks Energy and Climate Outlook (2017) Denmark's Energy and Climate Outlook 2017. Denmark.
- Eriksen J (2001) Nitrate leaching and growth of cereal crops following cultivation of contrasting temporary grasslands. *Journal of Agricultural Science*, 136, 271–281.
- Hansen EM, Eriksen J (2016) Nitrate leaching in maize after cultivation of differently managed grass-clover leys on coarse sand in Denmark. *Agriculture, Ecosystems and Environment*, 216, 309–313.
- Nielsen, O.-K., Plejdrup, M.S., Winther, M., Nielsen, M., Gyldenkærne, S., Mikkelsen, M.H., Albrektsen, R., Thomsen, M., Hjelgaard, K., Fauser, P., Bruun, H.G., Johannsen, V.K., Nord-Larsen, T., Vesterdal, L., Callesen, I., Caspersen, O.H., Rasmussen, E., MG (2013) Denmark ' S National Inventory Report. Aarhus.
- Qiao C, Liu L, Hu S, Compton JE, Greaver TL, Li Q (2015) How inhibiting nitrification affects nitrogen cycle and reduces environmental impacts of anthropogenic nitrogen input. *Global Change Biology*, 21, 1249–1257.

## COMPARATIVE EFFECT OF INORGANIC N ON PLANT GROWTH AND N<sub>2</sub> FIXATION OF TEN LEGUME CROPS

GUINET, M., NICOLARDOT, B., DUREY, V., REVELLIN, C., LOMBARD, F., PIMET, E., BIZOUARD, F., VOISIN, A.S.

UMR Agroécologie, AgroSup Dijon, CNRS, INRA, Université Bourgogne Franche Comté, France

### INTRODUCTION

Legumes are able to establish a symbiosis with *Rhizobium* bacteria and to fix atmospheric nitrogen (N<sub>2</sub>). Thus, N nutrition of legumes can rely on both symbiotic nitrogen fixation (SNF) and on soil inorganic N uptake. Despite potential complementarity between these two N sources, N deficiency can be observed (Voisin and Gastal., 2015), especially when plant nutrition mostly relies on SNF (Moreau et al., 2008). Moreover, the proportion of N derived from SNF relative to total N uptake (% Ndfa) is known to be negatively affected by inorganic N available in the soil (Voisin et al., 2002). In view of this particular characteristic, the reintroduction of legume crops should play a key role in cropping system sustainability by allowing a reduction of nitrogen (N) inputs. A diversity of legume crops adapted to various pedoclimatic conditions exist and could meet these challenges. However, there is a lack of references on a wide range of legume crops. Furthermore, the few studies on legume species other than pea make comparison among species relatively difficult due to different experimental conditions. The main objectives of our study were to i) compare ten grain legumes for their response to inorganic N in terms of N accumulation, for comparable field experimental conditions, ii) understand the differences among the 10 species for SNF inhibition by inorganic N. For this, we also examined plant ability to uptake soil inorganic N and plant growth, which may explain variations among species in the level of SNF inhibition by inorganic N.

### MATERIALS AND METHODS

A field experiment was carried out in 2014 at the INRA experimental site of Bretenière (Eastern France). Ten legume crops were sown either in March (faba bean, common vetch, lentil, lupin, pea) or in May (fenugreek, chickpea, common bean, soybean, Narbonne vetch) depending on the physiology of each species. All seeds were inoculated at sowing with species-specific strains of N<sub>2</sub>-fixing bacteria. Non-fixing reference crops were also sown: barley in March and sorghum in May. At sowing, inorganic N content in the first 60 cm of the soil were 69 and 84 kg N ha<sup>-1</sup> in March and May, respectively. Different levels of N fertiliser (0, 50, 150 and 300 kg N ha<sup>-1</sup>) were applied at both sowing dates, in the form of NH<sub>4</sub>NO<sub>3</sub>. To estimate SNF, the <sup>15</sup>N isotope dilution technique was used, with barley or sorghum as reference crops. 5 kg N ha<sup>-1</sup> of NH<sub>4</sub>NO<sub>3</sub> labelled with <sup>15</sup>N (1 % <sup>15</sup>N enrichment) was additionally spread on all crops at each sowing date. Shoots were harvested at physiological maturity and dry matter (DM), N concentration (% N), <sup>15</sup>N enrichment were measured for each crop and % Ndfa was calculated.

### RESULTS AND DISCUSSION

The amount of shoot N accumulated over the whole growth cycle greatly varied among species. When no N fertilizer was applied (ON treatment), shoot N ranged from 94 to 360 kg N ha<sup>-1</sup>. For common vetch, lentil, lupin, fenugreek, Narbonne vetch, and soybean the level of N fertilizer did not significantly affect the shoot N amount. For common bean, faba bean, pea, and chickpea, the 300N treatment differed from the ON treatment, with the amount of shoot N compared to the ON treatment being increased by 11, 17, 33, and 57 %, respectively. For both sowing dates, a negative relationship between % Ndfa and the amount of inorganic N available at sowing was observed for all species but with great differences in the response intensity among species. As an indicator of this response intensity, the amount of inorganic N available at sowing, for which % Ndfa was equal to 50 %, was calculated. It ranged from 82 to 251 kg N ha<sup>-1</sup> for common bean to faba bean, respectively the most and least responsive to soil N (Figure 1). This indicator was positively related to mean shoot N amounts at maturity, as averaged for the four levels of N fertilization. However, great differences were observed among species according to their ability to uptake soil inorganic N. As an indicator of plant ability to uptake soil N, theoretical N uptake efficiency of inorganic N available at sowing (NUEt) was calculated. This is the ratio between the amount of total inorganic N uptake by the legumes when SNF was equal to 50 % (corresponding to half of the total amount of

shoot N at maturity), and the amount of inorganic N available at sowing required to inhibit SNF by 50 % of total shoot N (Figure 1). Faba bean, lupin, fenugreek and Narbonne vetch had a NUE value lower than 0.5, indicating that the amount of inorganic N they retrieved was twice less than the amount available at sowing. In contrast, chickpea, common bean, common vetch, lentil, pea, soybean had NUE equal or higher than 0.5. Common bean was the most efficient to uptake inorganic N (NUE = 0.94), meaning that almost all the inorganic N available at sowing was retrieved by the plant.

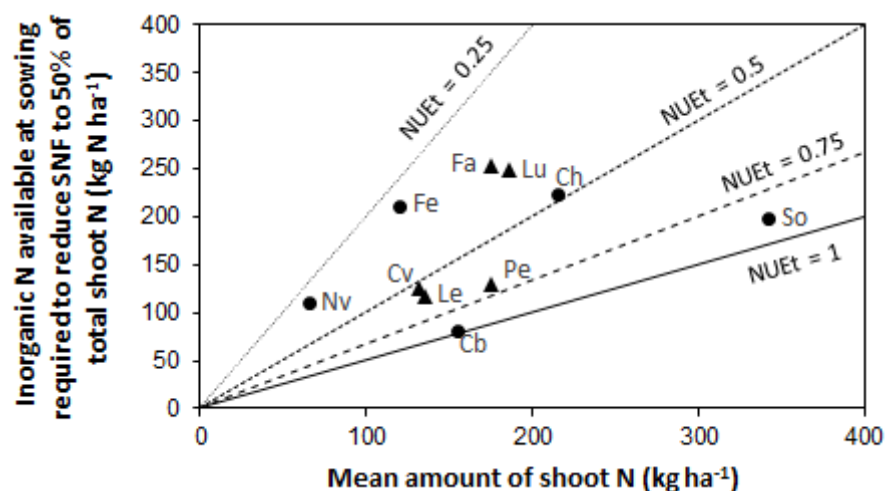

Figure 1. Relationships between (i) the mean shoot N amounts measured at maturity and (ii) inorganic N available at sowing for which % Ndfa was equal to 50 % (calculated using four level of N fertilization), measured for ten legumes species sown in a single field experiment, either in March 2014 (▲) and May 2014 (●). Cb: common bean, Ch: Chickpea, Cv: Common vetch, Fa: Fababean, Fe: Fenugreek, Le: Lentil, Lu: Lupin, Nv: Narbonne vetch, Pe: Pea, So: Soybean. The curves represent iso-efficiency uptake of inorganic N available at sowing.

## CONCLUSION

While N fertilization had little effect on the amount of shoot N, SNF decreased with the level of inorganic N available at sowing with great differences among the ten legume species. Our field experiment allowed us to classify ten legume species according to their inorganic N uptake efficiency. We suggest that this ability to retrieve inorganic N might be a key element to understand the differences of SNF apparent inhibition by soil inorganic N. A better understanding of plant traits leading to a better NUE of inorganic N is crucial to avoid N losses, leaching being often observed in legume based rotations (Plazza-Bonilla., 2015). To go further, comparison of root architecture of the ten legume species is currently studied.

**Acknowledgements:** M. Guinet PhD work was granted by INRA and the Ministry in charge of Agriculture. This experimental work was supported by the ANR LEGITIMES and Bourgogne-Franche-Comté Region (France).

## REFERENCES

- Moreau, D., Voisin, A. S., Salon, C., Munier-Jolain, N. 2008. The model symbiotic association between *Medicago truncatula* cv. *Jemalong* and *Rhizobium meliloti* strain 2011 leads to N-stressed plants when symbiotic N<sub>2</sub> fixation is the main N source for plant growth. *Journal of exp botany*, 59, 3509-3522.
- Plaza-Bonilla, D., Nolot, J.-M., Raffaillac, D., and Justes, E. (2015). Cover crops mitigate nitrate leaching in cropping systems including grain legumes: field evidence and model simulations. *Agriculture, Ecosystems & Environment* **212**, 1-12.
- Voisin, A.-S., Gastal, F. 2015. Nutrition azotée et fonctionnement agrophysologique spécifique des légumineuses. In "Les légumineuses pour des systèmes agricoles et alimentaires durables" (A. Schneider and C. Huyghe, eds.), 79-137. editions Quae.
- Voisin, A. S., Salon, C., Munier-Jolain, N. G., Ney, B. 2002. Quantitative effects of soil nitrate, growth potential and phenology on symbiotic nitrogen fixation of pea (*Pisum sativum* L.). *Plant and Soil*, 243, 31-42.

## THE EFFECT OF SEPARATING PIG SLURRY ON NITROGEN USE EFFICIENCY AND NITROGEN LOSS PATHWAYS FROM WINTER WHEAT ON CONTRASTING SOIL TYPES

THORMAN, R.E.<sup>1</sup>, MUNRO, D.G.<sup>1</sup>, BENNETT, G.<sup>2</sup>, EDWARDS, D.J.<sup>1</sup>, KINGSTON, H.L.<sup>1</sup>, WILLIAMS, J.R.<sup>1</sup>

<sup>1</sup> ADAS Boxworth, Battlegate Road, Boxworth, Cambridge, CB23 4NH, UK; <sup>2</sup> ADAS Gleadthorpe, Meden Vale, Mansfield, NG20 9PD, UK

### INTRODUCTION

Agriculture is fundamental in feeding a growing global population, but at the same time faces the challenge of minimising climate change and other environmental impacts. The use of new and modified manure management technologies has the potential to improve nitrogen (N) use efficiency (NUE) and minimise the loss of N to air (ammonia and nitrous oxide) and water (nitrate). Slurry separation on farms is a practical method to improve slurry management and has the potential to increase NUE by producing a high dry matter (DM), low readily available N, easily transported solid fraction, and a low DM, high readily available N liquid fraction (Fangueiro et al., 2015). The relatively low DM content of the liquid fraction compared to whole slurry can increase slurry infiltration into the soil reducing ammonia (NH<sub>3</sub>) loss & hence indirect nitrous oxide (N<sub>2</sub>O) emissions, as well as increasing grain yield and N uptake by the crop. However, the reduced NH<sub>3</sub> loss conserves N in the soil, which may result in an increase in direct N<sub>2</sub>O emissions and nitrate (NO<sub>3</sub>) leaching losses. The use of nitrification inhibitors (NIs) has been shown to reduce direct N<sub>2</sub>O emissions, but NIs may also influence crop yields and N recovery, as well as NH<sub>3</sub> and NO<sub>3</sub> losses with consequential effects on indirect N<sub>2</sub>O emissions. In the UK the use of slurry separation is increasing, therefore there is a need to investigate the effect that slurry separation (& combined with NIs) has on N loss pathways and crop available N supply following application to contrasting soil types.

### MATERIAL AND METHODS

Field experiments were carried out on two commercial arable farms in England with contrasting soil types. Site 1 was located near Cambridge, eastern England (average annual rainfall 565 mm) on a clay soil (c.40% clay). Site 2 was located near Mansfield, central England (average annual rainfall 650 mm) on a sandy loam soil (c.12% clay). At both sites treatments were applied to replicated (x3) plots (5 x 15 m) on cereal stubble in autumn 2016 and to separate plots with a growing winter wheat crop in spring 2017. Whole pig slurry and separated pig slurry - liquid fraction was applied by trailing hose using a custom-made small plot applicator. Separated pig slurry - solid fraction was applied by hand. Application rates were based on manure N analysis to give a target N loading for all the manures of 100-150 kg total N ha<sup>-1</sup>. In a separate treatment, the commercially available NI, dicyandiamide (DCD) was tested; prior to application, DCD (1% solution) was mixed with separated pig slurry - liquid fraction to give a DCD application rate of 10 kg ha<sup>-1</sup>. The N supplied by the DCD was accounted for in the total N application value. Additionally, for comparison with the manure treatments, ammonium nitrate and urea fertiliser were also applied at a rate of 150 kg N ha<sup>-1</sup> to separate plots. A control treatment was included where no nitrogen was applied.

Following N application, measurements of direct N<sub>2</sub>O were made over 6 months, using 5 static chambers (0.8 m<sup>2</sup> total surface area) per plot and based on the method described by Chadwick et al., (2014). The sampling strategy was weighted with more intensive sampling in the first 6 weeks after application. Gas headspace samples were analysed by gas chromatography. The N<sub>2</sub>O flux was calculated based on the linear increase in N<sub>2</sub>O concentration inside the chamber. The assumed linear relationship was checked on each sampling occasion. Cumulative fluxes following land spreading were calculated using the trapezoidal rule. Nitrous oxide emission factors were calculated by subtracting the fluxes from the control plots and expressed as the percentage of total-N applied.

Ammonia emissions were measured using a wind tunnel technique (Nicholson et al., 2017) for 1 week following applications of whole pig slurry and the separated fractions, and for 2 weeks following application of the manufactured N fertilisers. One wind tunnel per plot was set up immediately after application with each wind tunnel being moved on a daily basis. Nitrate leaching losses were measured following the autumn application at

site 2 only. Porous ceramic cups (5 per plot) were installed at a depth of 90 cm during the period of over-winter drainage (Webster et al., 1993). Samples were taken every 2 weeks or after 25 mm of rain, whichever was soonest. Drainage volumes were estimated using IRRIGUIDE (Bailey and Spackman, 1986) and were combined with NO<sub>3</sub> concentrations to quantify the amounts of NO<sub>3</sub>-N leached.

Soil temperature was logged continuously, along with measurements of air temperature and daily rainfall recorded at a nearby meteorological station. On every N<sub>2</sub>O measurement occasion, representative soil samples were taken (0-10 cm) from each plot for the determination of gravimetric moisture and soil mineral N (ammonium-N and nitrate-N) content.

The fertiliser N replacement value of the organic manure treatments was calculated by comparing yields and crop N offtakes from plots receiving applications of manufactured N fertiliser; ammonium nitrate was applied in spring 2017 to replicated (x3) plots (3 x 15 m), at 6 rates ranging from 0-300 kg N ha<sup>-1</sup>.

Grain yields and total crop N offtake were measured from all plots (including the N response) at harvest in 2017. ANOVA was conducted to determine experiment and treatment differences.

## RESULTS AND DISCUSSION

Results will be presented and discussed in terms of the potential that slurry separation has on improving winter wheat NUE and the effect that separation has on N loss pathways. We will examine the possible impact of using a NI combined with separation on the mitigation of gaseous emissions and NO<sub>3</sub> leaching losses, as well as any benefits to crop production. Additionally, the replacement of manufactured N fertilisers with the organic manures tested in these experiments will be discussed in relation to possible agronomic and environmental damage or indeed benefits.

**Acknowledgements:** This experiment forms part of the UK-China Virtual Joint Centre for Closed-Loop Cycling of Nitrogen in Chinese Agriculture (N-CIRCLE), funded from the Newton Fund via The Biotechnology and Biological Sciences Research Council (BBSRC).

## REFERENCES

- Bailey R.J., Spackman E., 1996. A model for estimating soil moisture changes as an aid to irrigation scheduling and crop water-use studies: I. Operational details and description. *Soil Use Manage.*, 12, 122-129.
- Chadwick D.R., Cardenas L., Misselbrook T.H., Smith K.A., Rees R.M., Watson C.J., McGeough K.L., Williams J.R., Cloy J.M., Thorman R.E., Dhanoa M.S., 2014. Optimizing chamber methods for measuring nitrous oxide emissions from plot-based agricultural experiments. *Eur. J. Soil Sci.*, 65, 295-307.
- Fangueiro D., Surgy S., Fraga I., Cabral F., Coutinho J., 2015. Band application of treated cattle slurry as an alternative to slurry injection: implications for gaseous emissions, soil quality and plant growth. *Agric. Ecosyst. Environ.*, 211, 102–111.
- Nicholson F., Bhogal A., Cardenas L., Chadwick D., Misselbrook T., Rollett A., Taylor M., Thorman R., Williams J., 2017. Nitrogen losses to the environment following food-based digestate and compost applications to agricultural land. *Environ. Pollut.*, 228, 204-516.
- Webster C.P., Shepherd M.A., Goulding K.W.T., Lord E.I., 1993. Comparisons of methods for measuring the leaching of mineral nitrogen from arable land. *J. Soil Sci.*, 44, 49-62.



## WHAT LIMITS SHEEP URINE-N<sub>2</sub>O EMISSIONS IN THE UPLANDS: NITRIFICATION OR C AVAILABILITY?

MARSDEN, K.A.<sup>1</sup>, HOLMBERG, J.A.<sup>1</sup>, JONES, D.L.<sup>1</sup>, CHARTERIS, A. F.<sup>2</sup>, CÁRDENAS, L.M.<sup>2</sup> AND CHADWICK, D.R.<sup>1</sup>

<sup>1</sup> School of Environment, Natural Resources and Geography, Bangor University, Bangor, Gwynedd, LL57 2UW, UK; <sup>2</sup> Rothamsted Research, North Wyke, Okehampton, EX20 2SB

### INTRODUCTION

There are > 33 million sheep in the UK (DEFRA, 2017), many of which graze land classed as ‘Less Favourable Areas’ (LFA), which are typically situated on mountainous terrain with poor production conditions (e.g. acidic soils, sloping land, high rainfall, cool climate and short growing season). According to Armstrong (2016), 88%, 80%, 69% and 16% of the agricultural land area in Scotland, Wales, England and Northern Ireland, respectively, falls within the LFA classification. The large numbers of livestock grazing on upland pastures (enclosed hill land and mountain areas) both in the UK, and globally, is a potentially large source of the greenhouse gas (GHG) nitrous oxide (N<sub>2</sub>O), via excretal deposition of nitrogen (N) to soil. Data to quantify N<sub>2</sub>O emissions from such areas, with urine as the N source, are particularly scarce. We aim to provide accurate and representative (in terms of urine chemical composition, patch size and volume) sheep urine patch N<sub>2</sub>O emission factors (EF), for two contrasting grazing seasons: summer and autumn, on unimproved common land. Due to slow rates of nitrification, we hypothesise that the N<sub>2</sub>O EF from urine patches will be lower than would be measured from lowland mineral soils, indicating that national emissions from such areas are currently over-estimated.

### MATERIAL AND METHODS

#### Study site, experimental design and treatments

The study took place within the Carneddau mountains (556 m a.s.l.), in the Snowdonia National Park (53°22′N, 3°95′W). The vegetation is comprised of NVC classification H12 (*Calluna vulgaris* – *Vaccinium myrtillus* heath; Elkington et al., 2001), overlaying a Histosol soil type. The site was excluded of stock (Welsh Mountain ewes; *Ovis aries*) from 15<sup>th</sup> May 2017, and study sites contained 12 plots (1.5×1.5 m; treatments in a randomised block design), for both seasons. Sheep urine was collected *in-situ*, from penned ewes. Treatments ( $n=4$ ) for summer included: i) control, ii) artificial sheep urine (920 kg N ha<sup>-1</sup>) and iii) real sheep urine (930 kg N ha<sup>-1</sup>). Urine patches were applied in triplicate within the GHG chambers. Based on the summer application results, and limited quantities of real urine, treatments for autumn were: i) control, ii) artificial urine (1120 kg N ha<sup>-1</sup>), and iii) NO<sub>3</sub><sup>-</sup> and glucose (100 kg N ha<sup>-1</sup> and 200 kg C ha<sup>-1</sup>). Treatment iii) was applied to determine the capacity for denitrification-related N<sub>2</sub>O emissions without substrate limitation (soil moistures were high and assumed not to limit denitrification).

#### Soil and GHG sampling and analysis

GHG emissions were monitored using a mobile, automated GHG monitoring system, with 12 static chambers (Scheer et al., 2014). The system captured N<sub>2</sub>O, CO<sub>2</sub> and CH<sub>4</sub> data at a resolution of 8 flux measurements day<sup>-1</sup>. Within-chamber soil solution was collected via Rhizon soil solution samplers ([Rhizosphere](#) Research Products, Wageningen, Netherlands) and soil cores were taken using an auger from replicated treatments outside the chambers. Soil solution and K<sub>2</sub>SO<sub>4</sub>-extracts were analysed for NO<sub>3</sub><sup>-</sup>, NH<sub>4</sub><sup>+</sup>, dissolved organic C and total dissolved N over the study period. Cumulative N<sub>2</sub>O fluxes were determined via integration and EF values were expressed as a % of the total N applied.

## RESULTS AND DISCUSSION

The magnitude of mean N<sub>2</sub>O fluxes from real (in summer) and artificial sheep urine (in summer and autumn) were low and did not peak above 40 µg N<sub>2</sub>O-N m<sup>-2</sup> h<sup>-1</sup>. In contrast, the magnitude of mean fluxes from the NO<sub>3</sub><sup>-</sup> and glucose treatment were much higher, peaking at just under 800 µg N<sub>2</sub>O-N m<sup>-2</sup> h<sup>-1</sup>. Cumulative emissions and EF values for the treatments are shown in Table 1. The EF values for all urine treatments (real or artificial) were lower than comparable values from lowland mineral soils. We suggest EF values for urine deposition to UK soils could be disaggregated based on productivity gradients. In summer, evidence for nitrification (i.e. increasing NO<sub>3</sub><sup>-</sup> within soil solution), was only observed in one replicate of the real urine treatment and artificial urine treatments, where a corresponding N<sub>2</sub>O peak occurred. This suggests generally low rates of nitrification (potentially due to the low soil pH of 4.38) were limiting N<sub>2</sub>O production via both nitrification and denitrification. High N<sub>2</sub>O emissions from the NO<sub>3</sub><sup>-</sup> and glucose treatment demonstrated a high capacity for denitrification in these soils. Microbial C-limitation seems unlikely in these organic soils, but is possible if C is bound in non-available forms. Through further laboratory incubation experiments, a mechanistic understanding of what limits N<sub>2</sub>O emissions from these soils will be gained.

*Table 1. Season of treatment application, measurement period (days), treatment type, cumulative N<sub>2</sub>O emissions over the measurement period (mg N<sub>2</sub>O-N) and EF values for treatment application (% of total N applied).*

Season	Measurement period (days)	Treatment	Cumulative emissions (mg N <sub>2</sub> O-N)	EF (%)
Summer	177	Control	0.20 ± 0.07	-
		Artificial sheep urine	0.48 ± 0.11	0.01 ± 0.00
		Real sheep urine	0.62 ± 0.47	0.02 ± 0.02
Autumn	118	Control	0.28 ± 0.11	-
		Artificial sheep urine	0.28 ± 0.13	0.00 ± 0.00
		NO <sub>3</sub> <sup>-</sup> + glucose	11.7 ± 2.6	0.69 ± 0.15

## CONCLUSIONS

Our study provides novel high-frequency N<sub>2</sub>O flux data for sheep urine applied to UK upland peat soil. Extremely low emissions were observed from the urine patch in both seasons, in addition to low rates of nitrification. Results of the study provide EF values for sheep urine deposited to upland soils which provide evidence to refine the UK agricultural GHG inventory and can further be used to calculate more accurate sustainability metrics for upland lamb (e.g. life cycle analysis and C footprint) and will contribute towards evidence-based decision making for the future of UK upland land management

**Acknowledgements:** Thanks to the Uplands-N<sub>2</sub>O project team, Emily Charlotte Cooledge, Danielle Hunt, Rob Brown, Mark Hughes, Llinos Hughes & Andrew Packwood for assistance with the study. Thanks to Snowdonia National Park, Natural Resources Wales, the National Trust and Aber & Llanfairfechan Graziers Association for allowing the site to be used. This work was funded under NERC under grant award (NE/M015351/1).

## REFERENCES

- Armstrong E., 2016. Research Briefing The Farming Sector in Wales, National Assembly for Wales.
- DEFRA, 2017. Agriculture in the United Kingdom 2016.
- Elkington T., Dayton N., Jackson D.L, Strachan I.M., 2001. National Vegetation Classification: Field Guide to Mires and Heaths, JNCCC, Peterborough, UK, pp 98-99.
- Scheer C., Rowlings D.W., Firrel M., Deuter P., Morris S., Grace P.R., 2014. Impact of nitrification inhibitor (DMPP) on soil nitrous oxide emissions from an intensive broccoli production system in sub-tropical Australia. *Soil Biol. Biochem.*, 77, 243-251.

## **GASEOUS EMISSIONS OF 3 TREATMENTS (CONTROL, COVERED, COVERED+COMPACTED) SOLID MANURE HEAP AT STORAGE**

LORINQUER, E.<sup>1</sup>, CHARPIOT, A.<sup>1</sup>, FOUGERE, M.<sup>3</sup>, LECOMTE, M.<sup>2</sup>, ROBIN, P.<sup>2</sup>

<sup>1</sup> Institut de l'Élevage, Monvoisin BP 85225, 35652 LE RHEU Cedex, France; <sup>2</sup> INRA UMR-SAS, 65 Rue de Saint Briec, 35042 Rennes, France; <sup>3</sup> La Touche, 44590 Derval, France

### **INTRODUCTION**

From the environmental point of view, ammonia emissions are partly responsible for acidification and eutrophication. In France, agriculture contributes 97% to national ammonia emissions which 46% comes from bovine farms (CITEPA, 2010). Different regulations at international, european and national levels have been established to limit particulate emissions, including ammonia, and sign up for part in the National Health and Environment Plan (NESP). As part of the proposed measures to reduce gas emissions in agriculture, it is necessary to pay attention to their feasibility from the point of view of their environmental efficiency and of their relevance at the farmer scale. Emissions from storage, which represent nearly 13% of nitrogen losses (as ammonia) from the bovine livestock operation, has however been little studied in France. This is particularly the case of cattle solid manure whose emissions are ignored while 68.7 million tons of cattle manure are produced each year in France, representing 80% of the total mass of cattle manure. EMAFUM project, funded by ADEME, had three main objectives: (i) development of a simplified method for the measurement of cattle manure storage (modeling and intermittent measurements), (ii) acquisition of reference values on emission kinetics deep litter heap (DLH) in representative conditions of livestock, (iii) evaluating the effect on gas emissions of three manure management modes (control heap, heap covered by a geotextile covering, covered + compacted heap) of deep litter during storage. This study focused on point (iii) that is based on the most dry and compact category of manure ('FTC') that represented in 2010, 25% of the solid manure produced by dairy farms and 65 % of the solid manure produced by meat farms.

### **MATERIAL AND METHODS**

#### **Farm and manure characteristics**

The solid manure studied comes from a Pays de la Loire dairy farm. During accumulation period, there were 69 Holstein dairy cows in 400 m<sup>2</sup> straw based loose housing (10 kg of straw/cow/day). Dairy cows were fed with maize silage, grass silage and concentrates (respectively 38kg, 17kg, 7kg of raw matter per cow), and they produced 28 kg milk.day<sup>-1</sup>.cow<sup>-1</sup> during the accumulated period with an average of 6 months lactation stage. After removal from the barn, 5 tons of solid manure per heap have been stored on a platform from 13/02/2013 to 22/04/2013. Three storage modalities of this solid manure have been tested at the experimental farm of Derval: (i) Control (Cont.) manure stored in a heap, (ii) Covered (Cov.) with a polypropylene cover (Gangloff® Toptex) and (iii) Covered + compacted (Cov. + Comp.) with tractor at storage.

#### **Gaseous emissions**

Temperatures have been followed at different heights (30, 60 and 90cm) with thermocouples linked with a CR3000 (Campbell Scientific). Gaseous emissions were followed during 2 days (48 hours) every week for 11 weeks with dynamic chamber systems (Greenhouse structure covered by a plastic cover usually used to cover maize silage). Gas concentration were measured at entry and exit of dynamic chamber with an infrared photoacoustic analyser (INNOVA 1412). Ventilation rate was controlled with Fancom mechanical fan, and punctually controlled anemometer (TSI 8470, TH-industrie, Paris). During 1 week, from 27/02 to 6/03/13, heaps have been covered and SF6 tracer gas has been introduced at entry to estimate and validate the ventilation rate of the fan. All along the

trial, air entry size and ventilation rate have been adapted in order to keep a sufficient difference between entry and exit air concentrations to calculate the gradient concentration ( $[\text{Gas}_{\text{outlet}}] - [\text{Gas}_{\text{inlet}}]$ ). Leachates were collected, weighted and analysed regarding rainfall during all the storage period. Gas emissions were calculated by multiplying concentration gradients and ventilation rates. Emissions between two measurements points have been estimated with a linear interpolation.

## RESULTS AND DISCUSSION

Ammonia emissions range from 4 to 12% total nitrogen originally present in the heap, probably related to the low ammonia nitrogen content of this type of effluent (11-34% of TAN – “total ammonium nitrogen” – TAN representing 35% of initial nitrogen).  $\text{N}_2\text{O}$  emissions ranged between 0.08 and 0.2% of total nitrogen initially present. Liquid losses of nitrogen (nitrate, ammonia) were less than 1% of the initial total nitrogen. The decrease in nitrogen of deep litter cattle manure occurs mostly in the form of dinitrogen ( $\text{N}_2\text{-N}$ ; 24-28% of the initial total nitrogen for the control and the covered pile, and 4% for the compacted treatment). This study shows that  $\text{NH}_3\text{-N}$ ,  $\text{N}_2\text{O-N}$  and  $\text{CH}_4\text{-C}$  emissions occur predominantly during the first month of storage for deep litter heap (FTC), respectively in the range of 97 to 100%, 41 to 56% and 82 to 90% depending on the treatment. The treatments studied in this project confirmed the hypothesis of ammonia emission reductions by covering or compacting (Petersen & Sommer, 2011). The uncertainty on emission reduction (in % of initial total nitrogen) was less than 6%, but remained high considering the uncertainty about the initial composition of manure (above 20%) and the repeatability of pile setting up (complex geometrical shape, lack of turning equipment). Covering the pile induced a decrease in biological activity by limiting the wetting from rain. This result should be confirmed with further measurements covering the variability of pile setting and climates (rainfall). Regarding GHG emissions, covering the pile did not reduce emissions. On the contrary, the compaction has a significant impact: nearly 10 times increase the amount of methane emitted. This is unacceptable to consider recommending compaction heap at storage. Staying at the scale of single storage is a bit simplistic, particularly at the level of ammonia that can be emitted after spreading, particularly when the manure is entered in the soil after 48h. Indeed, the control heap contains no more ammonia nitrogen at the end of storage, which suggests a limited volatilization during spreading. The covered heap had little bit less volatilization during storage, but it still contains 3 kg of  $\text{NH}_3$  at the end of the period, which could be more easily volatilized during spreading.

## CONCLUSION

Ammonia losses were less than 12% of initial nitrogen for all treatments. This study confirmed that solid manure (FTC) is a very heterogeneous product and sampling and characterization is hard. Moreover in France there is a very high diversity of solid manure types linked to farm practices (feed ration, type and amount of litter, type of housing, grazing, animal productivity,...), so further investigation are required to have an overview of diversity at national scale on the whole manure management chain.

**Acknowledgements:** Acknowledgements, to the partners: IRSTEA Rennes, INRA UMR SAS, Derval experimental farm and the funder ADEME.

## REFERENCES

- CITEPA, 2010. Inventaire des émissions de polluants atmosphériques en France – Séries sectorielles et analyses étendues – Format SECTEN, 247p.
- Petersen S. O., S. G. Sommer, 2011. Ammonia and nitrous oxide interactions: Roles of manure organic matter management. *Animal Feed Sci. and Technol.* 166– 167, 503– 513.

## RECOVERY OF NITROGEN FROM DEPTH BY GRASSLAND SPECIES IN NORWAY

BYERS, E., RAUT, P., DÖRSCH, P., EICH-GREATOREX, S., BLEKEN, M.A.

Faculty of Environmental Sciences and Natural Resource Management, Norwegian University of Life Sciences, Norway

### INTRODUCTION

In grassland systems, perennial ryegrass is often included for its good forage nutritional value and high yields. In Norway it has also been suggested as a catch crop to reduced leached mineralized nitrogen ( $N_{\min}$ ). However, it has poor winter survival and persistence in Norway (Sturite et al., 2007). There are contradictory reports about the rooting depth and relative ability to recover  $N_{\min}$  which has been leached to deeper soil layers (Hoekstra et al., 2015, Malcolm et al., 2015).

The purpose of this study was to compare recovery of  $N_{\min}$  from depth throughout one season by perennial ryegrass (*Lolium perenne* L.) with other grassland species commonly grown in Norway. Fast-growing perennial ryegrass was expected to uptake  $N_{\min}$  quickly, but not from depth. Three other tall grasses – tall fescue (*Festuca arundinacea* L.), meadow fescue (*Festuca pratensis* Huds.), and timothy (*Phleum pratense* L.) were included, with deepest-rooting tall fescue expected to recover the greatest amount of  $N_{\min}$  from depth. Kentucky bluegrass (*Poa pratensis* L.), included for its suitability to grazing conditions, has shallower rooting activity and was expected to take up the least  $N_{\min}$  from depth among the grasses. Red clover (*Trifolium pratense* L.) and white clover (*Trifolium repens* L.) were included because they are nitrogen-fixing, and were expected to take up less  $N_{\min}$  than the grasses, though deeper-rooting red clover was expected to recover more from depth than white clover.

### MATERIAL AND METHODS

A  $^{15}\text{N}$ -labeling study was performed in an established grassland trial in its second production year. Four replicate plots of each species in pure stands were labeled with  $^{15}\text{NH}_4\text{Cl}$  adsorbed to zeolite. The zeolite was buried at 43 cm in a 4x4 array of 16 holes, for an effective loading of  $0.07 \text{ g } ^{15}\text{N m}^{-2}$  within each experimental harvest area of approximately  $0.5 \text{ m}^2$ . Biomass from each of three harvests in 2016, plus the first harvest of 2017, was analyzed for dry matter yield, N content and  $^{15}\text{N}$ .

To account for different yields and nitrogen contents between species, the cumulative recovery of  $^{15}\text{N}$  (1<sup>st</sup> harvest, 1<sup>st</sup> + 2<sup>nd</sup> harvest, 1<sup>st</sup> + 2<sup>nd</sup> + 3<sup>rd</sup> harvest, all harvests) was plotted versus the cumulative total N content. Differences between species  $^{15}\text{N}$  uptake were tested in a general linear model with total N, species, and their interaction as regressors. Species were introduced into the model as dummy variables. A natural log transformation of total N was found to give the best model. ANOVA of  $^{15}\text{N}$  recovery by species was also performed for each harvest. The analysis was performed in R.

### RESULTS AND DISCUSSION

Contrary to the expectation that tall fescue would recover the most  $N_{\min}$  from depth, it recovered the same amount of  $^{15}\text{N}$  as meadow fescue and timothy, both in terms of absolute  $^{15}\text{N}$  amount and relative to total N. Ryegrass in fact had the highest  $^{15}\text{N}$  recovery in the 2<sup>nd</sup> harvest of 2016 (growth period 1 June – 13 July), and the highest cumulative  $^{15}\text{N}$  per total N. This may indicate an advantage of using ryegrass as a catch crop for leached  $N_{\min}$  mid-season. As expected, these four tall grasses had higher cumulative  $^{15}\text{N}$  recovery than shallower-rooting bluegrass.

Nitrogen-fixing red clover and white clover recovered less  $^{15}\text{N}$  and had higher total N concentrations, thus having lower  $^{15}\text{N}$  uptake per total N than all the grasses. Their  $^{15}\text{N}$  uptake was not different to that of the grasses in the

3<sup>rd</sup> harvest of 2016 (growth period 13 July – 2 September), perhaps because the original <sup>15</sup>N loadings in the grass plots were more depleted by that time. White clover was not harvested in the first cut of 2016 due to poor early spring growth; this explains its lower <sup>15</sup>N uptake compared to red clover. Despite the deeper rooting of red clover, there was no significant difference in <sup>15</sup>N uptake between red and white clover in the 2<sup>nd</sup> or 3<sup>rd</sup> harvest of 2016. Red clover did however recover more <sup>15</sup>N than white clover in early spring 2017.

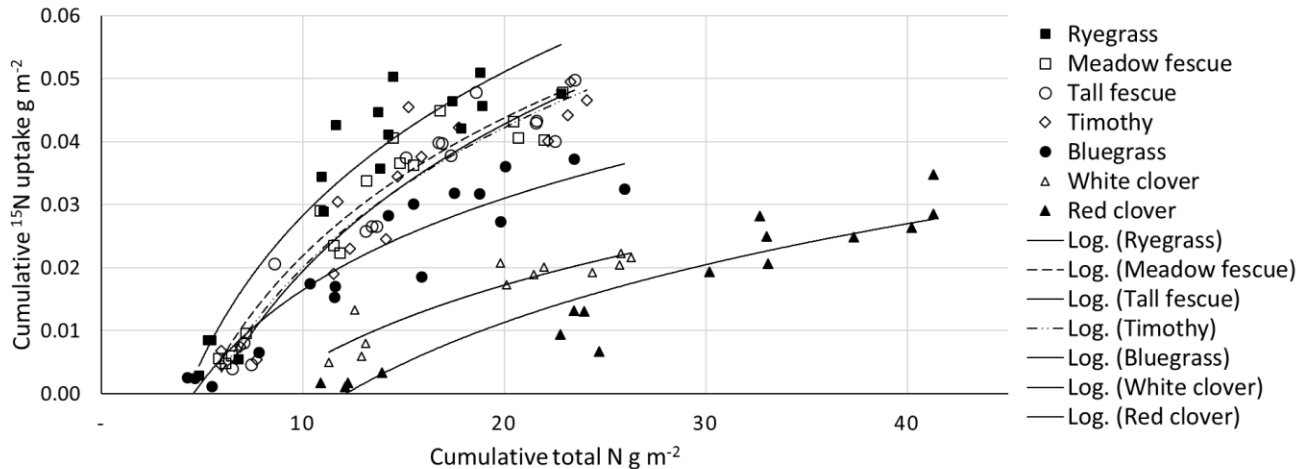

Figure 1. Cumulative <sup>15</sup>N uptake in four consecutive harvests, plotted versus cumulative total N content of harvested herbage. Symbols mark replicate values (4 per treatment X harvest combination). Logarithmic least square trend lines for tall fescue, meadow fescue and timothy were not significantly different from each other, whereas those for all other species were significantly higher or lower than this group ( $p < 0.05$ ).

## CONCLUSION

Ryegrass may perform well in recovering deep-leached  $n_{\min}$  mid-season in sub-boreal climates. Tall fescue was not better at  $n_{\min}$  uptake from depth than the other tall grasses. Clovers and bluegrass may recover  $n_{\min}$  from depth later in the season, with red clover recovering more than white clover in the early spring due to better growth. The ability to recover and retain  $n_{\min}$  also depends on the persistence and overwinter survival into following years. Therefore in 2017, the 2016 study was followed up with continued harvests of the original plots, and the experiment was also repeated with newly-labeled plots (results forthcoming).

## REFERENCES

- Sturite, I., Henriksen, T.M., Breland, T.A., 2007. Winter losses of nitrogen and phosphorus from Italian ryegrass, meadow fescue and white clover in a northern temperate climate. *Agriculture, Ecosystems & Environment* 120, 280–290.
- Hoekstra, N.J., Suter, M., Finn, J.A., Husse, S., Lüscher, A., 2015. Do belowground vertical niche differences between deep- and shallow-rooted species enhance resource uptake and drought resistance in grassland mixtures? *Plant and Soil* 394, 21–34.
- Malcolm, B.J., Moir, J.L., Cameron, K.C., Di, H.J., Edwards, G.R., 2015. Influence of plant growth and root architecture of Italian ryegrass (*Lolium multiflorum*) and tall fescue (*Festuca arundinacea*) on N recovery during winter. *Grass and Forage Science* 70, 600–610.

## IS THE SPATIAL DEPENDENCE OF NITROGEN AND SULPHUR COMBINABLE FOR SITE SPECIFIC MANAGEMENT?

CORDOVA, C.

Departamento de Suelos y Recursos Naturales, Facultad de Agronomía, Universidad de Concepción, Chile

### INTRODUCTION

Crop yield and quality are key aspects to achieve global food security, and nitrogen (N) is essential to meet the production target to feed the increasing world population. However, the natural N supply from the soil is restrictive for crop growth, and mineral or organic application of N is often necessary. The interaction between N and sulfur (S) (Maynard et al., 1983), due to the similarities in their soil cycles, might help to increase the efficiency of N uptake and therefore decrease the rate of N applied. Moreover, the quality of crop production in terms of protein, essential amine acids or fatty acids might be improved by the S application.

Site specific fertilization within a field needs to identify areas with differential nutrient supply, i.e., the mineralization process. The classification of the differential zones is made according to the analysis of the spatial dependence and variability of a soil property/process. A nested analysis of variance allows the investigation of multiple intervals of distance in a single analysis (Lark, 2011), and provides a good approximation to the variogram for spatial interpolation (Webster et al., 2007) to map differential areas.

Therefore, the objective of this study is to analyse the spatial dependence of N and S mineralization at the field scale, which might lead to a combined fertilizer recommendation and management if they are spatially correlated.

### MATERIAL AND METHODS

#### Soil sampling

This research was carried out in a site at the fringes of the Andes Mountains (36°59'S 71°55'W) with rainfall around 1500 mm year<sup>-1</sup> and the slope between 3-8%. The crop rotation was oat-wheat, established on a Andisol soil (11.09 % soil organic matter, 8.79 cmol kg<sup>-1</sup> soil exchange capacity, 14.30 mg kg<sup>-1</sup> available N, 14.60 mg kg<sup>-1</sup> available P, 324.50 mg kg<sup>-1</sup> available K, 30.0 mg kg<sup>-1</sup> available S).

Soil samples were collected in Autumn season, at 0-10 cm depth, considered relevant for the active mineralization process. A number of 96 soil samples were obtained, instead of 486, from an efficient nested sampling design (Webster and Lark, 2013) over a 4 ha field, where sampling intervals of 121.5 m were organized as a triangle (replicated twice within the field) and from each node other sampling intervals were hierarchically marked away at 40 m, 13.5 m, 4.5 m and 1.5 m, and then sampled. From each sample mineralization indicators for N and S were measured.

#### Nitrogen and sulfur supply assessment

Potentially available nitrogen (PAN) was measured to estimate the natural soil contribution to N supply. Ammonium was measured on air-dry soil samples by colorimetric analyses, and after seven days of anaerobic soil incubation at 40°C. The ammonium was extracted from the soil using 2M KCl solution (1:5), and the color development was obtained using 3M NaOH and Nessler reactive solutions. The color intensity was measured at 490 nm. The PAN was calculated as the difference of the mineralized N at the end of the incubation and the initial amount in the soil. Sulphur mineralization was measured by open soil incubation held on Buchner funnel for seven days at 22°C. The sulfate in the soil was extracted using a 10mM CaCl<sub>2</sub> solution (1:5) and the sulfate concentration was measured by ion-chromatography.

## Data analysis

The statistical summary of the data sets was calculated to analyze the central and dispersion parameters of N and S variables. The N and S mineralization results were analyzed by maximum residual likelihood (REML) to obtain the components of variance from each scale studied and determine the spatial dependence, using Genstat package 16<sup>th</sup> Ed. (VSN international, 2014).

## RESULTS AND DISCUSSION

The mean value for the index of N supply was  $32.92 \pm 17.36$  N-NH<sub>4</sub><sup>+</sup> kg<sup>-1</sup> and the S-SO<sub>4</sub><sup>-2</sup> mineralized was  $6.45 \pm 4.83$  mg kg<sup>-1</sup>. The range, 90.04 mg N-NH<sub>4</sub><sup>+</sup> kg soil<sup>-1</sup> and 26.23 mg S-SO<sub>4</sub><sup>-2</sup> kg soil<sup>-1</sup>, and variance of N and S values of mineralization measured were large, showing the spatial variation of the soil supply of these two elements for crop nutrition, i.e., some locations within the field are deficient whilst others show a surplus. This could be associated to the soil clay content stabilizing organic matter, and regulated by soil moisture.

The data set of N and S mineralized were skewed and so a log-transformation was applied for the REML analysis. The partial components of variance were accumulated from the shortest distance interval to the largest one (Table 1) and the resulting limit of spatial dependence of PAN was detected at 40.5 m, where 59% of the variance was obtained. S mineralization reached the spatial dependence at 40.5 m, encompassing 53% of the variance (Table 1). Although N and S mineralization showed the same limit of spatial dependence, the partial components of variance showed a different approach to the variogram (figures not shown) which needs to be further analyzed by spatial correlation, particularly for the 4.5 m scale.

*Table 1. Components of variance and the spatial dependence for an index of soil nitrogen supply and sulfur mineralization from an Andisol under cereal crop rotation.*

Interval distance	Potentially available nitrogen			Sulfur mineralization		
	Component of variance	Accumulated variance	% of total variance	Component of variance	Accumulated variance	% of total variance
121.5 m	0.313	0.763	100	0.028	0.060	100
40.5 m	0.000	0.450	59	0.000	0.032	53
13.5 m	0.250	0.450	59	0.000	0.032	53
4.5 m	0.200	0.200	26	0.032	0.032	53
1.5 m	0.000	0.000	0	0.000	0.000	0

## CONCLUSION

Preliminary results show that a plausible sampling distance to simultaneously account for the spatial variability of N and S supply is 20 m, half of the limit of spatial dependence. However, spatial correlation analysis will define the exact relationship between N and S.

**Acknowledgements:** This research was funded by Conicyt-Fondecyt 11130447.

## REFERENCES

- Lark, R.M., 2011. Spatially nested sampling schemes for spatial variance components: scope for optimization. *Comput. Geosci.*, 37: 1633-1641.
- Maynard, D.G., J.W.B, Steward, and J.R, Bettany, 1983. Sulfur and nitrogen mineralization in soils compared using two incubation techniques. *Soil Biol. Bioch.*, 15: 251-256.
- Webster, R., Oliver, M. 2007. *Geostatistics for environmental scientists*. John Wiley & Sons, Ltd. Chichester, UK.
- Webster, R. and R.M. Lark., 2013. *Field sampling for environmental science and management*. Routledge. Milton Park, UK.
- VSN International, 2014. *GenStat for Windows 16th Edition*. VSN International, Hemel Hempstead, UK.



## **NITROGEN TURNOVER FROM CONTRASTING COMPLEX ORGANIC MATRIXES - EXAMPLES FROM <sup>15</sup>N STABLE ISOTOPE STUDIES WITH COMPOST AND DIGESTED SLURRIES**

MAYER, J.<sup>1</sup>, KOEPPE, P.<sup>1</sup>, DUBOIS, A.<sup>1</sup>, HUTTER, M.<sup>1,2</sup>

<sup>1</sup> Department of Agroecology and Environment, Agroscope, Switzerland; <sup>2</sup> School of Life Sciences and Facility Management, ZHAW, Switzerland;

### **INTRODUCTION**

Organic waste composts, manure or digested slurries with or without co-fermentation are complex organic matrixes containing organic substrates from various origins and quality. Process studies on nitrogen (N) flows, source specific losses and N use efficiency (NUE) in a plant soil system require the use of <sup>15</sup>N tracers. One option is the direct labelling of the whole matrix of the organic fertiliser, containing organic and inorganic N forms. However, this option is coupled with very high efforts and costs, e.g. feeding animals with labelled feed. Another option is to label only inorganic N-forms for fertilizers containing high proportions of those. This restricts observations on inorganic forms. A third option is an indirect approach by <sup>15</sup>N enrichment of the soil and determination of N flows by dilution of previously labelled functional soil / plant pools, e.g. plant N or soil mineral N, etc., by an unlabelled fertiliser source. However, this option requires a more or less homogenous enrichment of the soil organic matter to avoid misinterpretations of isotope data. Those are caused by e.g. pool substitution of an unlabelled by a labelled source and thus results in an overestimation of e.g. N crop uptake from the applied fertiliser.

### **MATERIAL AND METHODS**

Here we compare the results from two <sup>15</sup>N tracer studies with compost (Mayer et al. 2011), slurries and digested slurries (Hutter et al. 2017). i) In a four year pot experiment we examined the N uptake of crops and N flows through soil pools like microbial biomass and mineral N fractions. We used <sup>15</sup>N labelled compost and compared it with isotope dilution of previously, over a one year period, <sup>15</sup>N labelled soil; ii) In a one year field experiment we compared N uptake by maize from slurries and digested slurries. We labelled the NH<sub>4</sub>-N fraction of the slurries with (<sup>15</sup>NH<sub>4</sub>)<sub>2</sub>SO<sub>4</sub> and compared the uptake from the NH<sub>4</sub>-N fraction with the N-uptake determined by isotope dilution where we have labelled the field soil with <sup>15</sup>N enriched clover-grass powder two months before slurry application (details see contribution of Hutter, M. et al. at this conference).

### **RESULTS AND DISCUSSION**

Homogeneous <sup>15</sup>N labelling of a municipal waste compost worked very well by co-composting of <sup>15</sup>N labelled ryegrass (data not shown). Both methods directly <sup>15</sup>N labelled compost and isotope dilution showed similar results for N uptake from compost (Fig. 1), compost N immobilization in microbial biomass and compost N in the mineral N fraction during the whole 4 years period. However, the N recovery from compost determined by isotope dilution in soybean as third crop in the crop rotation caused negative compost N recoveries. N<sub>2</sub>-fixation by the legume as a second unlabelled N source lead to an apparent dilution of the labelled N pool and thus to misinterpretation of N uptake from compost (Fig. 1). In the field study the NUE of the NH<sub>4</sub>-N fraction in maize determined by <sup>15</sup>N labelling was 34% for slurries and 45% for digested slurries. A simple difference calculation, using an unfertilised plot as control, revealed a NUE of 24% for slurries and 38% for digested slurries related to total N. Both methods showed the same pattern. However, the isotope dilution approach failed here. We got a complete different pattern and in single field plots NUE above 100%. We attributed this to an inadequate homogeneous labelling of the soil organic matter two months before slurry application (details and figures see contribution of Hutter, M. et al. at this conference).

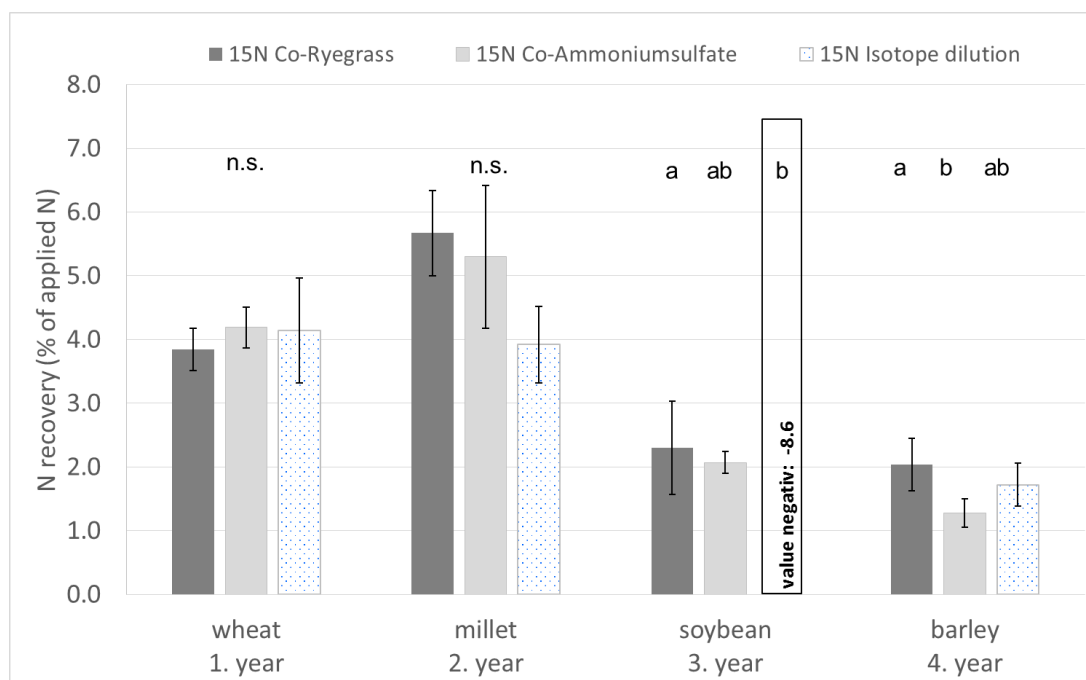

Figure 1. Recovery of applied compost N by crops with directly  $^{15}\text{N}$  labelled compost by  $^{15}\text{N}$ -ryegrass or  $(^{15}\text{NH}_4)_2\text{SO}_4$  or by  $^{15}\text{N}$  isotope dilution in a four years model crop rotation (pot experiment). Different letters indicate significant differences ( $p < 0.05$ ).

## CONCLUSION

The comparison of the two studies at pot and field scale shows clearly the advantages of direct  $^{15}\text{N}$  labelled organic matrices compared to an isotope dilution approach. Direct  $^{15}\text{N}$  labelling by co-composting of labelled organic substrates worked well and can be done with low efforts. However, the production of homogeneously labelled organic fractions in manures is coupled with high efforts and costs, and it is almost impossible for mixed substrates e.g. manure digested with different co-substrates. So isotope dilution might be an option for those organic substrates, but requires further methodological development.

## REFERENCES

- Hutter M., Krebs R., Mayer J., 2017: Nitrogen use efficiency of raw and digested slurries: A study using different  $^{15}\text{N}$  methods. In: Wolfrum S. et al. (Eds.). Beiträge zur 14. Wissenschaftstagung Ökologischer Landbau. Freising-Weißenstephan. Verlag Dr. Köster, Berlin, pp. 314-317.
- Mayer, J.; Koeppe, P., Dubois, A., 2011: Turnover of compost nitrogen in an organic model crop rotation. A comparison of direct and indirect labelling  $^{15}\text{N}$  tracer methods. In: Leithold et al. (Eds.). 11. Wissenschaftstagung Ökologischer Landbau. Verlag Dr. Köster, Berlin, pp. 181-182.

## MODELLING C-N-P-K SOIL DYNAMICS IN A CONTEXT OF REPEATED COMPOSTS APPLICATIONS

REVALIER, A.<sup>1</sup>, ORVAIN, M.<sup>1</sup>, BISINELLA DE FARIA, A. B.<sup>1</sup>, NAVES-MASCHIETTO, G.<sup>1</sup>, ALBUQUERQUE, M.<sup>1</sup>,  
HOUOT, S.<sup>2</sup>, HARTMAN, M.<sup>3</sup>, PARTON, B.<sup>3</sup>

<sup>1</sup> Veolia Recherche & Innovation, France; <sup>2</sup> INRA Ecosys, France; <sup>3</sup> Colorado State University, United States of America

### INTRODUCTION

In a context of high environmental impact of fertilizer use and soil organic matter (OM) degradation, recycling nutrients and stabilizing soil OM through organic residues applications such as composts has become an essential objective of sustainable farming. However, efficient use of compost is still a challenge, due to high variability of OM mineralization that depends on its quality and on various soil and climate characteristics. Modelling and simulation of OM mineralization and its impacts on N, P and K dynamics play an important role when understanding nutrient interactions and optimizing compost spreading.

The Century model (Parton et al., 1987) describes the different OM pools dynamics in agricultural soils at monthly scale and considers pedo-climatic context and farming practices including residual organic matter additions. This study describes the modifications to Century and the validation of the results with a long-term field experiment in France.

The aim of this study is to modify, calibrate and validate Century model in order to correctly predict C, N, P and K in soil and differentiate between different compost spreading strategies for a French pedo-climatic context.

### MATERIAL AND METHODS

#### Integration of ISMO index to Century model

Century describes the dynamics of soil organic matter and nutrient cycling between 3 different pools: active, slow and passive soil organic matter (SOM). These SOM pools are supplied by structural and metabolic C, N, P and S pools. In the first study (data not published), it was noted that the effects of different composts additions on soil organic matter mineralization was not precisely predicted. To be able to differentiate between the types of amendment used, the Organic Matter Stability Index (ISMO) (Lashermes et al., 2009) of composts was integrated to Century. Century uses the ISMO to divide organic matter into the structural carbon and the slow organic carbon pools. Between ISMO of 36% to 90%, the OM going into the slow organic carbon pool is linearly proportional to the value of ISMO. Consequently, the flow going into the structural pool decreases with the increase of ISMO. In addition, it is important to predict K due to its fertilization effect and its presence in organic amendments. Therefore, the dynamics of S, initially simulated by Century, have been adapted to describe K dynamics in soil, based on the SOM mineralization and C/K ratios to describe the fluxes between different pools.

#### Model validation

To validate the modifications in the model, an experimental dataset provided by the long-term field experiment QualiAgro (INRA-Veolia partnership, <http://www6.inra.fr/qualiagro>) dedicated to compost application, was used. In the QualiAgro experiment, three types of composts and farm manure were applied every two years on a loamy soil cropped with corn and winter wheat from 1998 to 2013. Control plots (TEM) were cropped without organic amendments and half of the experimental sites were fertilized (EXPERIMENT\_N) while the other part received no mineral fertilizer, leading to 10 different treatments which are replicated 4 times. Also, the ISMO value of organic amendments was measured along with soil characteristics including C, N, P and K stocks. Statistical analyses using linear regression were conducted to compare model predictions and measurements. Three different organic amendments (including municipal solid waste compost - OMR) and the control treatments were used to calibrate the model while a last treatment (compost of sludge and green waste - DVB) was used to validate the calibration.

## RESULTS AND DISCUSSION

The model predictions showed strong correlations with experimental soil total organic carbon ( $r^2=0.91$ ) and soil total organic nitrogen stock ( $r^2=0.90$ ) as shown in Figure 1 for TEM\_N, OMR\_N and DVB\_N. Also, the modified version of Century distinguished precisely the scenarios with and without amendments as well as the type of compost regarding its stabilization level.

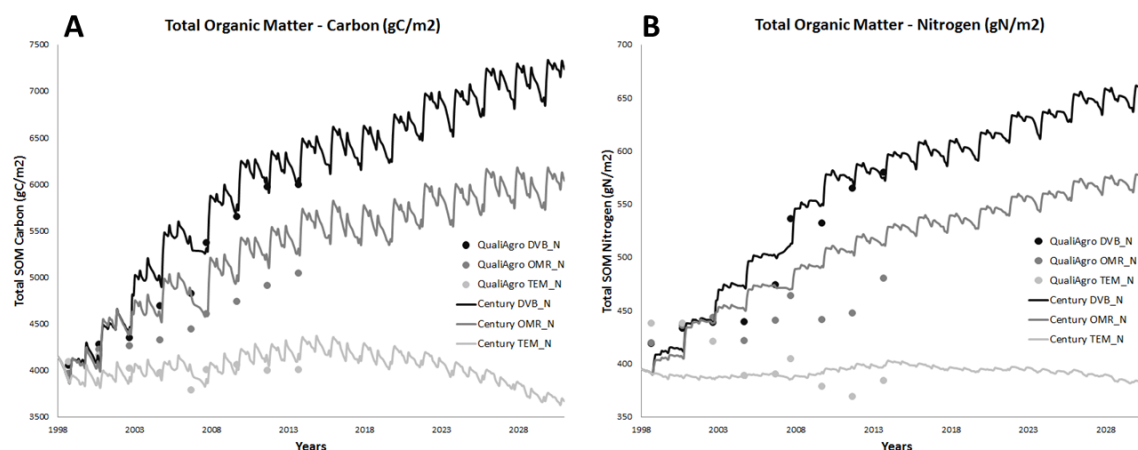

Figure 1. Total Soil Organic Matter Carbon (A) and Nitrogen (B). Comparison among Century results and QualiAgro data for TEM\_N (control plot with mineral N fertilization), OMR\_N (municipal solid waste compost with mineral N fertilization) and DVB\_N (sludge and green waste compost with mineral N fertilization).

Predictions of exchangeable P and K stocks in soil (data not shown) were also in accordance with the measurement values. However, more experimental data concerning total P and K are needed to improve the whole P and K dynamics in soil.

## CONCLUSION

The calibration and validation of the modified Century model implemented with ISMO and K showed encouraging results for the French organic amendment scenarios. As a next step, a sensitivity analysis and more powerful calibration tools will be used to decrease the uncertainty of Century prediction. Also, the use of different calibration and validation datasets will enhance the capability of the model to predict C, N, P and K soil dynamics in various French pedo-climatic and organic amendment contexts.

**Acknowledgements:** The authors acknowledge INRA Ecosys for providing QualiAgro experimental data.

## REFERENCES

- Parton, W. J., Schimel, D. S., Cole, C. V., & Ojima, D. S. (1987). Analysis of factors controlling soil organic matter levels in Great Plains grasslands. *Soil Science Society of America Journal*, 51(5), 1173-1179.
- Lashermes, G., Nicolardot, B., Parnaudeau, V., Thuriès, L., Chaussod, R., Guillotin, M. L., ... & Tricaud, A. (2009). Indicator of potential residual carbon in soils after exogenous organic matter application. *European Journal of Soil Science*, 60(2), 297-310.

## IMPACT OF THE UREASE INHIBITOR LIMUS® ON AGRONOMIC AND ENVIRONMENTAL PARAMETERS IN TEMPERATE GRASSLAND.

KROL, D.J.<sup>1</sup>, FORRESTAL, P.J.<sup>1</sup>, WALL, D.<sup>1</sup>, LANIGAN, G.J.<sup>1</sup>, SANZ-GOMEZ, J.<sup>2</sup>, KNAUER, M.<sup>2</sup>, FORD, I.<sup>3</sup>, KELLY, G.<sup>4</sup>, RICHARDS, K.G.<sup>1</sup>

<sup>1</sup> Teagasc, Crops, Land Use and Environment, Johnstown Castle, Co. Wexford, Ireland; <sup>2</sup> BASF SE, Agricultural Solutions, Functional Crop Care, Limburgerhof, Germany; <sup>3</sup> BASF plc, Crop Protection, Business Development, Cheadle, United Kingdom, <sup>4</sup> BASF Ireland Ltd., Crop Protection, Business Development, Cork, Ireland

### INTRODUCTION

Nitrogen (N) fertilisation is the cornerstone of agricultural production however it can also lead to losses of a potent greenhouse gas nitrous oxide (N<sub>2</sub>O), air pollutant ammonia (NH<sub>3</sub>), and nitrate (NO<sub>3</sub><sup>-</sup>) leaching to the environment. Novel urea-based fertilisers that incorporate urease inhibitors in their formulations aim to abate these losses while maintaining and enhancing yields. One example of urease inhibitor is Limus® developed by the BASF (Sanz-Gomez *et al.* 2017), which is a combination of the active ingredients N-(n-butyl)-thiophosphoric-triamide (NBPT) and N-(n-propyl)-thiophosphoric-triamide (NPPT). The aim of this work was to test the feasibility of urea treated with Limus® for reducing N<sub>2</sub>O and NH<sub>3</sub> in a temperate grassland while maintaining or improving productivity.

### MATERIAL AND METHODS

Experimental work was conducted on a permanent grassland site in Johnstown Castle in Co. Wexford. Fertiliser treatments were: control, calcium ammonium nitrate (CAN), urea (U) and urea treated with Limus® (UL). The trial was a fully randomized block design with five blocks incorporating agronomy plots (10 m x 2 m), N<sub>2</sub>O plots (0.4 m x 0.4 m) and ammonia plots (2.5 m x 2 m) (three blocks). Treatments were applied to agronomic and N<sub>2</sub>O plots on the same days at a standard agronomic rate of 200 kg N ha<sup>-1</sup> yr<sup>-1</sup> in six split applications. Ammonia plots received fertiliser in July at a rate of 40 kg N ha<sup>-1</sup>. Dry matter yield was measured at every harvest, N<sub>2</sub>O was measured regularly throughout the growing period using the static chamber technique (de Klein and Harvey, 2012) and NH<sub>3</sub> was measured for two weeks post-fertilisation using the wind tunnel technique (Lockyer, 1984). Gaseous losses (N<sub>2</sub>O and NH<sub>3</sub>) are presented as emission factors (EFs) which is a ratio of N loss to N fertilisation rate (%). Statistical analysis was performed using the proc MIXED procedure of SAS followed by the F-protected Least Significant Difference test to check the effect of fertiliser treatment on cumulative N<sub>2</sub>O, NH<sub>3</sub> and grassland productivity.

### RESULTS AND DISCUSSION

#### Nitrous oxide

Fertilisation led to large increases in N<sub>2</sub>O emissions. The highest loss was observed from the CAN treatment representing EF of 0.74%. Emissions from urea-based fertilisers were not different from the control, whereas CAN emission was significantly higher (P<0.05) than the control and other fertilisers. Results indicate that urea treated with Limus® mitigated N<sub>2</sub>O to levels not significantly different to that of control.

#### Ammonia

Fertilisation resulted in large NH<sub>3</sub> losses with EF of up to 43.1%. There was a significant difference in NH<sub>3</sub> losses between different fertiliser formulations. Losses were largest from urea, however addition of the urease inhibitor with Limus® mitigated losses by 68 % to levels not significantly different to these from CAN.

#### Herbage production

There were differences between individual harvests, with first and second harvest returning low grass yields from all the treatments, while substantially larger yields were achieved during the third and fourth harvest. All fertilized

plots achieved significantly higher yields ( $P < 0.05$ ) compared with control unfertilized grassland, however there was no statistically significant difference between all the urea-based fertilisers.

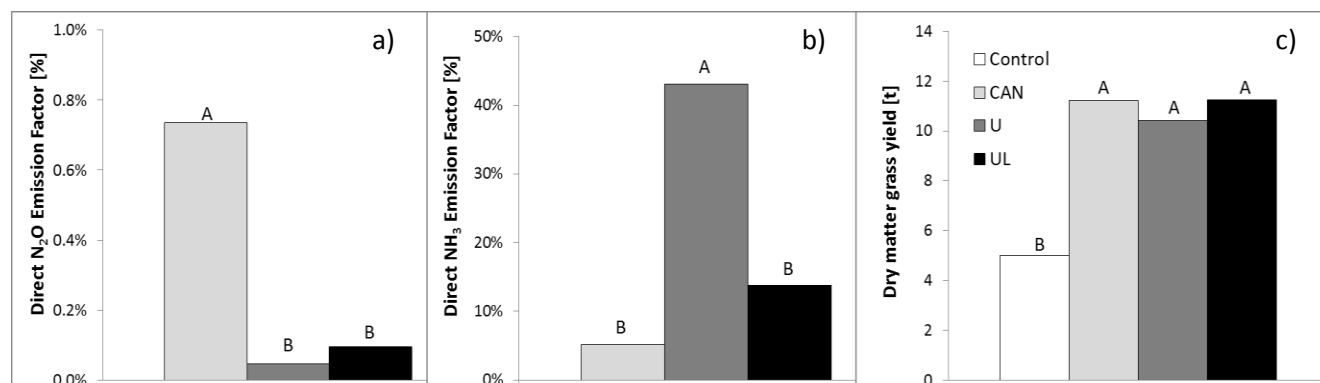

Figure 1 a-c. Losses of a) N<sub>2</sub>O, b) NH<sub>3</sub> and c) dry matter yield in temperate grassland following N fertilisation with various fertiliser formulations. Different letters indicate statistical significant differences using Tukey-Kramer grouping for Least Square Means  $P < 0.05$ .

## CONCLUSION

Outputs of this work clearly support the hypothesis that urea-based fertilisers with added urease inhibitors such as Limus<sup>®</sup> can help reconciling environmental and production targets of Irish agriculture by providing a win-win solution that not only lower environmental losses but simultaneously maintain production.

**Acknowledgements:** This research was financially supported by the Irish Research Council Enterprise Partnership Scheme Postdoctoral Fellowship (grant number EPSPD/2016/54) and BASF as industry partner.

## REFERENCES

- de Klein C.A.M., Harvey M., 2012. Nitrous oxide chamber methodology guidelines. [https://globalresearchalliance.org/wp-content/uploads/2015/11/Chamber\\_Methodology\\_Guidelines\\_Final-V1.1-2015.pdf](https://globalresearchalliance.org/wp-content/uploads/2015/11/Chamber_Methodology_Guidelines_Final-V1.1-2015.pdf) (Retrieved 30.04.2018)
- Lockyer D.R., 1984. A System for the Measurement in the Field of Losses of Ammonia through Volatilization. *Journal of the Science of Food and Agriculture*, 35, 837–848.
- Sanz-Gomez J., Knauer M., Pasda G., Wissemeier A., Staal M., Schneider K.H., Zerulla W., Schmid M., Meger H., Tarlazzi S., Munoz-Guerra L.M., Chiodini, M. E., Acutis M., Villar-Mir J.M., Muskulus A., 2017. Limus<sup>®</sup>: a novel combination of urease inhibitors reducing ammonia emissions from urea containing fertilizers and its performance concerning environmental and agronomic parameters, handling, transport and storage properties. Poster presented at the conference Sustainable Solutions for Sustainable Management of Nitrogen, Aarhus, Denmark.

## **GAS EMISSIONS DURING SOLID MANURE MANAGEMENT AT HOUSING AND STORAGE STAGES FROM DAIRY CATTLE IN CONTRASTED FEEDING AND CLIMATIC SITUATIONS**

EDOUARD, N.<sup>1</sup>, ROBIN, P.<sup>2</sup>, ALMEIDA, J.G.R.<sup>1,3</sup>, ALVES, T.P.<sup>1,3</sup>, LAMBERTON, P.<sup>1</sup>, LORINQUER, E.<sup>4</sup>

<sup>1</sup> PEGASE, INRA, Agrocampus-Ouest, Rennes, France; <sup>2</sup> SAS, Agrocampus-Ouest, INRA, Rennes, France; <sup>3</sup> Universidade do estado de Santa Catarina, UDESC Centro de Ciências Agroveterinárias, 88520-000 Lages SC, Brazil; <sup>4</sup> Institut de l'élevage, 149 rue de Bercy, Paris, France

### **INTRODUCTION**

French dairy systems are characterized by a large proportion of deep litter systems. However, gas emission measurements from solid manure are very scarce in the literature and also very variable in relation with contrasted litter management (fresh straw addition frequency and amount, accumulation time, animal type and feeding...). In deep-litter systems, manure is mixed with bedding material and accumulated for a few weeks in a thick layer where the oxygen level decreases with depth. This can result in several processes such as aerobic degradation of organic matter, urea hydrolysis, nitrification-denitrification, nitrogen immobilization and anaerobic degradation of organic matter (Jeppsson, 1999). These complex interactions among microbial, biochemical and physical processes lead to highly variable emissions of ammonia as well as greenhouse gases (Webb et al., 2012). The objective of this study was to acquire new knowledge about N<sub>2</sub>O and NH<sub>3</sub> emissions during accumulation of a straw-based deep litter at the dairy barn level and throughout the storage of the resulting solid manure. To consider different management practices, the experiment offered contrasting diets to the dairy cows (a grass-based GD and a maize silage-based diet MD) and was conducted at two seasons (autumn and spring) leading to variable grass quality and different climatic effects during storage. This led to 4 treatments to be compared: GDaut, MDaut, GDspr and MDspr.

### **MATERIAL AND METHODS**

#### **Housing**

At each season, two groups of three Holstein dairy cows in late (in autumn) or mid (in spring) lactation were housed in two closed and controlled mechanically ventilated rooms, and kept on a straw-based deep litter accumulated under the animals during four weeks. The MD diet consisted in an 80-20% mixture of maize silage and concentrate while GD was 100% grass. Individual milk yields and dry matter (DM) intake were recorded daily. NH<sub>3</sub> and N<sub>2</sub>O concentrations were measured continuously with an infrared photo-acoustic gas analyzer (Innova model 1412). Ventilation rate was punctually assessed with the tracer ratio method (SF<sub>6</sub>).

#### **Storage**

After 4 weeks of accumulation in the barn, solid manure was put in pile under dynamic chamber systems and stored during 14 weeks. The MDaut and GDaut heaps were therefore monitored during winter while the MDspr and GDspr heaps were monitored during spring and summer. NH<sub>3</sub> and N<sub>2</sub>O concentrations were measured with an infrared photo-acoustic gas analyzer (Innova model 1412) during the whole week following stacking and then 2 days a week (dynamic chambers uncovered the rest of the time). Ventilation rates were obtained from the fans. Leachates from manure heaps were continuously collected and analyzed for their composition.

### **RESULTS AND DISCUSSION**

#### **Housing**

Ammonia emissions were slightly greater on GD compared to MD in autumn and were lower and quite close from each other in spring (Table 1). GDaut ammonia emissions were also observed to increase gradually over the course of manure accumulation. It appeared that NH<sub>3</sub> emissions were more related to variation of milk urea content than

to CP content (15% for MD and 18% for GD at both season) or N intake itself (that was systematically higher in MD, because of higher DM intake). Milk urea content, good indicator of urinary urea N excretion (Burgos et al., 2007), is indeed the direct reflection of the unbalance degradable and metabolisable protein supplies of the grass, particularly important in the autumn grass. N<sub>2</sub>O emissions were classically low at the house level and were higher on GD than on MD whatever the season. The solid manure was indeed more humid and compacted with GD, probably stimulating denitrification processes causing N<sub>2</sub>O emissions.

### Storage

The peak of ammonia emission was reached the day after manure stacking; emissions then decreased down to zero 3 weeks after. As for housing, ammonia emissions were higher (even doubled) on GDaut than on MDaut in relation with a higher NH<sub>4</sub>-N content of the manure at the beginning of the storage period. On the contrary, NH<sub>3</sub> emissions were higher on MD than on GD in spring-summer. We observed that the MDspr manure heap was warmer (up to 85°C in the core of the heap) than the GDspr pile (65°C) and probably also more porous (less humid) stimulating ammonia volatilization. The GDspr heap lost consequently more N in the form of N<sub>2</sub>O.

*Table 1. Cumulated nitrogen gas emissions over the solid manure accumulation in the house and during consecutive storage. MD: maize silage diet; GD: grass-based diet; aut: autumn-winter period; spr: spring-summer period*

Cumulated gas emissions over the period		MDaut	GDaut	MDspr	GDspr
Housing (4weeks)	NH <sub>3</sub> -N, g/cow	406	468	354	321
	N <sub>2</sub> O-N, g/cow	2.6	7.6	2.3	6.3
Storage (14weeks)	NH <sub>3</sub> -N, g/cow	500	967	870	615
	N <sub>2</sub> O-N, g/cow	32	34	33	53

### CONCLUSION

Considering housing and storage, nitrogen gas losses represented 6, 11, 8 and 7% of the system N input (N intake + N from the straw) for MDaut, GDaut, MDspr and GDspr respectively. Feeding animals with fresh grass in the house does not seem to be relevant in term of environmental impacts with straw-based deep litter systems, especially in the autumn when grass degradable N content is high. Storage of solid manure during warm season should also be avoided because of the temperature effect stimulating ammonia volatilization. To go further, it would be interesting to compare these results with emission during grazing, to find the best way to combine grass valorization and maize yields to preserve milk production and environment.

**Acknowledgements:** This work was supported by Ademe. We are also grateful to the INRA staff both at the dairy experimental farm and at the laboratory.

### REFERENCES

- Burgos, S.A., Fadel, J.G., DePeters, E.J., 2007. Prediction of ammonia emission from dairy cattle manure based on milk urea nitrogen: Relation of milk urea nitrogen to urine urea nitrogen excretion. *J. Dairy Sci.*, 90, 5499-5508.
- Jeppsson, K.H., 1999. Volatilization of Ammonia in Deep-litter Systems with Different Bedding Materials for Young Cattle. *J. Agri. Eng. Res.* 73, 49-57.
- Webb, J., Sommer, S., Kupper, T., Groenestein, K., Hutchings, N.J., Eurich-Menden, B., Rodhe, L., Misselbrook, T.H., Amon, B., 2012. Emissions of ammonia, nitrous oxide and methane during the management of solid manures, in: Lichtfouse, E. (Ed.), *Agroecology and strategies for climate change*. Springer, pp. 67-107.



## PREDICTING C AND N FATE FROM MIXTURE OF SUGARCANE STRAW AND ORGANIC FERTILIZERS. MECHANISTIC APPROACH BY MODELING

KYULAVSKI, V.<sup>1,4,5</sup>, THURIÈS, L.<sup>1</sup>, RECOUS, S.<sup>3</sup>, PAILLAT, J.-M.<sup>2</sup>, GARNIER, P.<sup>4</sup>

<sup>1</sup> CIRAD, UPR Recyclage et Risque, Saint-Denis de La Réunion, France, <sup>2</sup> CIRAD, UPR Recyclage et Risque, Montpellier, France, <sup>3</sup> FARE laboratory, INRA, Université de Reims Champagne-Ardenne, Reims, France, <sup>4</sup> INRA-AgroParisTech, UMR1402 EcoSys, F-78850 Thiverval-Grignon, France, <sup>5</sup> ADEME, Angers, France.

### INTRODUCTION

Carbon (C) budget and nitrogen (N) mineralization in mulch cropping systems depend on both residue and fertilizer inputs. Mixing organic fertilizer – N and straw - C seems to lead to interactive relations, controlled by mineral N contents for OF (Aita et al. 2012, Giacomini et al. 2015) and N diffusion between microbial biomass and C sources (Garnier et al. 2008). However, predicting C and N fate when mixing different C and N sources is challenging, because it is necessary to better describe the mechanisms that drive the potential mineralization rates. The objective of our work was to study C and N mineralization from mixtures of plant residues and OF in soil, and to compare them with the mineralization of these OF applied alone.

### MATERIAL AND METHODS

#### Acquisition of experimental data

An incubation experiment of soil samples (Nitisol from La Reunion) was conducted during 182 days at 28°C in a dark room (AFNOR, 2016). The C-CO<sub>2</sub> was measured at 14 dates and mineral N was measured at 9 dates. The treatments included organic materials with different physicochemical characteristics either incubated alone as pig slurry (PS), digested solid sewage sludge (DS) and sugarcane straw (S), or incubated as mixtures, namely pig slurry with sugarcane straw (PS-S) and digested solid sewage sludge with sugarcane straw (DS-S). The doses of organic or mineral inputs were calculated to provide non-limiting organic N for the mixtures, and non-limiting mineral N (KNO<sub>3</sub>) for S treatment.

#### Modelling strategy

CANTIS is a mechanistic model simulating C and N transformations in soils (Garnier et al. 2003). CANTIS-simulated curves were fitted with a single set of parameters to the experimental data obtained with S, PS and DS treatments. The same set of parameters was used to predict the C-CO<sub>2</sub>, N-NO<sub>3</sub><sup>-</sup> and N-NH<sub>4</sub><sup>+</sup> kinetics from the mixtures (PS-S and DS-S). The difference between predicted and measured dynamics for the mixtures was considered as interactions. In CANTIS, the contact factor ( $K_{MZ}$ ) is an empirical function that accounts for modifications of the rate of microbial colonization of C source and/or N source. Since N limitation was previously attributed to the contact area between soil and residues (Garnier et al. 2008, Iqbal et al. 2014), we calibrated  $K_{MZ}$  to account for the interactions. The predictions were evaluated using Nash-Sutcliffe model efficiency index ( $E_f$ ).

### RESULTS AND DISCUSSION

Calibrating CANTIS model enabled a good prediction of all measured variables (CO<sub>2</sub>, NO<sub>3</sub><sup>-</sup> and NH<sub>4</sub><sup>+</sup>) for the treatments S, PS and DS and for the control soil, as all the Nash-Sutcliffe model efficiency indexes were positive. However, CANTIS model overestimated the CO<sub>2</sub> measured in both mixture treatments, PS-S and DS-S. This suggests a N limitation occurring when mixing different C and N sources, that CANTIS model does not consider using the parameters calibrated for a single organic source. Considerable improvement of the prediction of C and N kinetics was obtained by fixing  $K_{MZ}$  to 60 and 130, for PS-S<sub>corr</sub> and DS-S<sub>corr</sub> respectively, compared to PS-S and DS-S, respectively (fig. 1). The higher value of  $K_{MZ}$  for DS-S treatment, indicates that the N uptake was less efficient, compared to PS-S. This was probably due to the lower N diffusion and consequently, the lower N accessibility from

the sewage sludge. We hypothesized that the distance between N and C was responsible for the antagonistic interaction, that reduces C colonization by decomposers and leads to a lower CO<sub>2</sub> release, than in case of pure additivity ( $K_{MZ} = 0$ ).

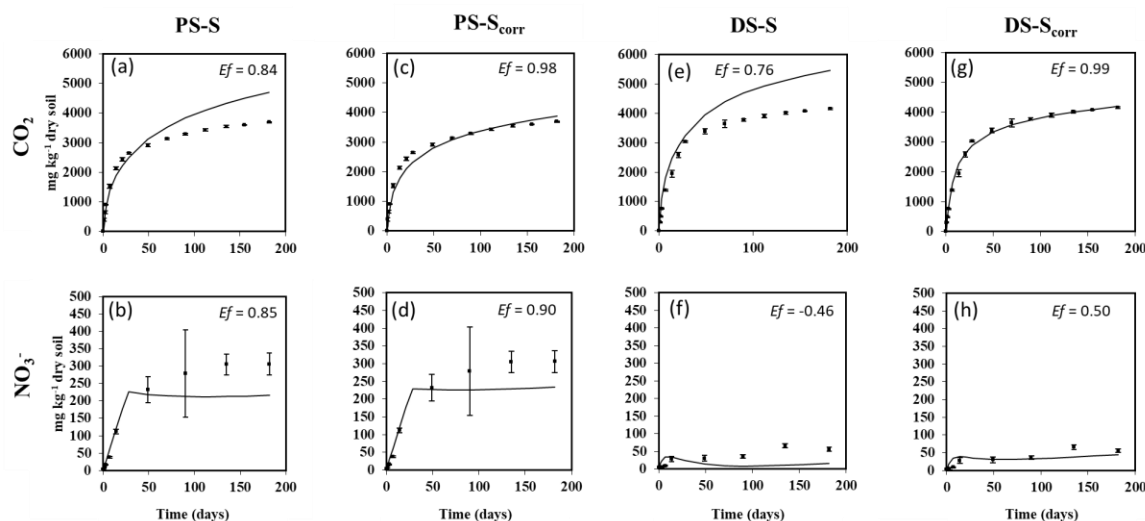

Figure 1: CANTIS-simulated (lines) and observed (dots, standard deviation) data for C and N mineralization kinetics during incubation of mixtures of organic materials in control soil with (PS-S) pig slurry and sugarcane straw (a, b), (PS-S<sub>corr</sub>) pig slurry and sugarcane straw with modified contact factor  $K_{MZ}$  (c, d), (DS-S) sewage sludge and straw (e, f) and (DS-S<sub>corr</sub>) sewage sludge and straw with modified contact factor  $K_{MZ}$  (g, h), and their corresponding Nash-Sutcliffe efficiency indices ( $E_f$ ).

## CONCLUSION

The transformations of C and N from different organic sources in mixture have been accurately simulated with CANTIS model, by including and optimizing a function that reflects the accessibility of N. Thus, it is necessary to better describe and integrate the chemical and physical variability that characterizes the organic fertilizers, which determines the rate of their accessibility.

## REFERENCES

- AFNOR, 2016. FD U 44-163 - Amendements organiques et supports de culture — Caractérisation de la matière organique par minéralisation potentielle du carbone et de l'azote. Soil improvers and growing media - Characterization of organic matter by potential mineralization.
- Aita, C., S. Recous, R. H. O. Cargnin, L. P. da Luz, and S. J. Giacomini. 2012. Impact on C and N dynamics of simultaneous application of pig slurry and wheat straw, as affected by their initial locations in soil. *Biol. Fertil. Soils* 48:633-642.
- Garnier, P., C. Cambier, M. Bousso, D. Masse, C. Chenu, and S. Recous. 2008. Modeling the influence of soil-plant residue contact on carbon mineralization: Comparison of a compartmental approach and a 3D spatial approach. *Soil Biol. Biochem.* 40:2754-2761.
- Giacomini, S. J., V. L. G. Simon, C. Aita, L. M. Bastos, D. A. Weiler, and M. Redin. 2015. Carbon and Nitrogen Mineralization in Soil Combining Sewage Sludge and Straw. *Rev. Bras. Ciênc. Solo* 39:1428-1435.
- Iqbal, A., P. Garnier, G. Lashermes, and S. Recous. 2014. A new equation to simulate the contact between soil and maize residues of different sizes during their decomposition. *Biol. Fertil. Soils* 50:645-655.

## QUALITY OF CARBON COMPOUNDS OF MAIZE ROOT AND SHOOT LITTER CONTROLS SHORT-TERM CO<sub>2</sub> AND N<sub>2</sub>O EMISSIONS FROM AGRICULTURAL SOILS

RUMMEL, P.S.<sup>1</sup>, PFEIFFER, B.<sup>1,2</sup>, PAUSCH, J.<sup>3</sup>, DITTERT, K.<sup>1</sup>

<sup>1</sup> Section of Plant Nutrition and Crop Physiology, Department of Crop Science, Georg-August-Universität Göttingen, Göttingen, Germany;

<sup>2</sup> Institute of Microbiology and Genetics, Dept. of Genomic and Applied Microbiology, Georg-August-Universität Göttingen, Germany;

<sup>3</sup> Institute of Agroecology, Faculty for Biology, Chemistry, and Earth Sciences, University of Bayreuth, Germany

### INTRODUCTION

Availability of easily biodegradable carbon (C) compounds is one of the main drivers of denitrification events in agricultural soils. Potential C sources are rhizodeposits, especially root exudates, and decaying plant and root biomass. Incorporation of plant residues into agricultural soils and its subsequent degradation increases microbial respiration and creates plant litter associated microsites with low O<sub>2</sub> concentrations. Together with the availability of nitrate (NO<sub>3</sub><sup>-</sup>) from residual fertilizers or mineralization, these microsites are becoming hotspots for denitrification. Studies investigating the effect of plant litter on nitrous oxide (N<sub>2</sub>O) emissions mainly considered C/N ratio and total C input as key variables (Chen et al., 2013), which control decomposition of plant litter in long-term studies. For short-term responses, however, the quality of C and N compounds is an important driver of denitrification. Water-soluble and low-molecular weight compounds can be directly used in the microbial metabolism, leading to an immediate increase of CO<sub>2</sub> and N<sub>2</sub>O fluxes. The composition of structural components further influences the microbial community in soil, with fungi being generally regarded as the main decomposers of plant materials rich in cellulose and lignin (Kögel-Knabner, 2002). In general, fungi are seen as major contributors to denitrification under aerobic and weakly anaerobic conditions, while bacterial denitrification predominates under strongly anaerobic conditions (Hayatsu et al., 2010). Thus, we hypothesize that quality of C compounds (i) is an important predictor for short-term N<sub>2</sub>O emissions and (ii) affects microbial denitrifier community structures.

### MATERIAL AND METHODS

In our study, maize plants (*Zea mays* L.) were grown in a greenhouse for eight weeks, harvested and all roots were removed from soil by sieving and handpicking. Soil, fresh plant shoot and root biomass were used in a 22-day two-factorial laboratory incubation experiment with two N levels (N1 and N2) and three litter addition treatments (Control = no litter input, Root = 100 g root FM kg<sup>-1</sup> dry soil, Root+Shoot = 100 g root FM + 100g shoot FM kg<sup>-1</sup> dry soil). The closed chamber technique was used to measure daily CO<sub>2</sub> and N<sub>2</sub>O fluxes and, soil nitrate and water-soluble C<sub>org</sub> concentrations were analyzed in regular intervals. A subsample of maize shoot and root litter was analyzed for total and water extractable carbon and nitrogen content, and structural components. Characteristics of maize biomass are shown in table 1. Microbial communities were analyzed using large-scale metabarcoding.

### RESULTS AND DISCUSSION

Maize shoot litter has a higher relative hemicellulose content, lower lignin/N ratio, slightly higher C/N ratio, and higher water soluble C<sub>org</sub> concentration compared to maize root litter (table 1). Addition of maize litter increased daily CO<sub>2</sub> and N<sub>2</sub>O emissions, cumulative emissions and the N<sub>2</sub>O/CO<sub>2</sub> ratio compared to Control (figure 1). The effect was much higher with incorporation of Root+Shoot litter, even when higher C inputs were taken into account. Differences in soil NO<sub>3</sub><sup>-</sup> concentration between N1 and N2 were very small, but significantly influenced N<sub>2</sub>O emissions when water-soluble C<sub>org</sub> concentrations were high.

We anticipate that higher litter input with higher biodegradability led to stronger anaerobicity in the Root+Shoot treatment compared to Root and Control. Additionally, shrinking of soil incorporated shoot litter created larger soil pores and facilitated rapid escape of generated N<sub>2</sub>O. Potentially, a higher share of N<sub>2</sub>O was further reduced

to N<sub>2</sub> in the Root treatment. Analyses of microbial community structures will give further insights. We expect differences in bacterial and fungal species richness and diversity between the different litter treatments.

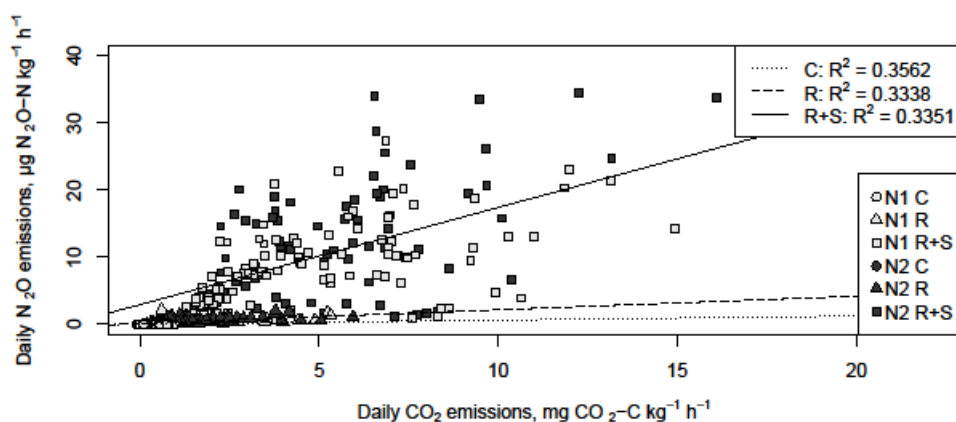

Figure 1. Daily N<sub>2</sub>O fluxes in relation to daily CO<sub>2</sub> fluxes from soils during a 22-day incubation experiment with two N levels (N1, N2) after incorporation of maize root biomass (R), maize root + shoot biomass (R+S) and control (C) without biomass. Regressions calculated with combined N levels (n=184).

Table 1. Chemical characteristics of maize root and shoot biomass used in the incubation experiment. Hemicellulose, cellulose and lignin are expressed relative to lignin content.

	Maize root	Maize shoot
C/N ratio	17.01	23.22
Lignin/N ratio	2.82	1.44
Water extractable C <sub>org</sub> (% of total C)	11.6	23.39
Hemicellulose (relative content)	3.36	9.08
Cellulose (relative content)	3.18	11.5
Lignin (relative content)	1	1

## CONCLUSION

Quality parameters, in particular the concentration of water-soluble C<sub>org</sub> and lignification, as well as total C input were the main factors influencing N<sub>2</sub>O losses from soil in this study.

**Acknowledgements:** This study was funded by the Deutsche Forschungsgemeinschaft through the research unit DFG-FOR 2337: Denitrification in Agricultural Soils: Integrated Control and Modelling at Various Scales (DASIM).

## REFERENCES

- Chen H., Li, X., Hu, F., Shi W., 2013. Soil nitrous oxide emissions following crop residue addition: a meta-analysis. *Global Change Biol.*, 19, 2956-2964.
- Hayatsu M., Tago K., Saito M., 2010. Various players in the nitrogen cycle: Diversity and functions of the microorganisms involved in nitrification and denitrification. *J. Soil Sci. Plant Nutr.*, 54, 33-45.
- Kögel-Knabner I., 2002. The macromolecular organic composition of plant and microbial residues as inputs to soil organic matter. *Soil Biol. Biochem.*, 34, 139-162.

## **NITRIFICATION INHIBITOR N-LOCK™ WITH OPTINYTE™ TECHNOLOGY – RESEARCH ON ENVIRONMENTAL AND AGRICULTURAL BENEFITS IN GRAIN CORN AND OILSEED RAPE**

DZIKOWSKI, M.<sup>1</sup>, PETERSON, M.<sup>2</sup>, LOURDET, Y.<sup>3</sup>

<sup>1</sup> Dow AgroSciences, Germany; <sup>2</sup> Dow AgroSciences, USA; <sup>3</sup> Dow AgroSciences, France

### **INTRODUCTION**

Nitrification inhibitors such as nitrapyrin improve retention of nitrogen in the root-zone, prevent nitrate leaching to the groundwater, and reduce greenhouse gas emissions (Wolt 2004). Nitrogen transformation processes are slowed enabling more nitrogen is available for the crops for longer period of time ([www.ipni.net](http://www.ipni.net)). This enables more nitrogen to be available later in the corn and oilseed rape growing season when options to fertilize are limited ([www.nitrogenmaximizers.com](http://www.nitrogenmaximizers.com)). Dow AgroSciences tested N-Lock™ nitrogen stabilizer in corn and oilseed rape to determine the impact of inhibiting nitrification with N-Lock on the soil, environment and crop growth and yield.

### **MATERIAL AND METHODS**

Dow AgroSciences established a series of field trials between 2013 and 2017 across Europe to evaluate the impact of N-Lock on crop growth and yield. Trials were located in: France, Spain, Germany, Poland, Hungary and Italy. N-Lock was incorporated into the soil either mechanically or using precipitation/irrigation: 15mm within 10 days after N-Lock application. In oilseed rape N-Lock was applied in spring on established crop before vegetation regrowth and in corn N-Lock was applied before planting.

#### **Trial design**

Plot-trials with randomized complete block design with 3 to 4 replicates to ensure reliable yield determination, independent on soil variation. The untreated reference (nitrogen applied without N-Lock) was compared with treated plots (nitrogen with N-Lock).

#### **Nitrogen Source**

Depending on the location nitrogen was delivered either in the form of mineral or organic fertilizer. Dose rate of nitrogen varied depending on local practices and supplemented nitrogen already available in the soil and was in range from 100 to 200 kg N/Ha.

#### **Product formulation**

N-Lock was used as a encapsulated formulation containing 200 g ai/L of nitrapyrin applied at 2,5 L/ha of formulated product which translate to a nitrapyrin rate of 500 g ai/ha. N-Lock was either mixed with liquid fertilizer such as UAN or applied separately from granular fertilizer with field sprayer.

#### **Crop**

A total of 68 and 42 were conducted in corn and winter oilseed rape, respectively. Both crops require nitrogen throughout the growing season, especially during late season growth stages when fertilizing is not possible due to the crop size. In corn, N-Lock™ nitrogen stabilizer and fertilizers were applied in spring before planting and in oilseed rape N-Lock and fertilizer were applied in spring on established crop.

#### **Application and incorporation practice**

Depending on the local practice and situation N-Lock was applied either with field sprayer or tank mixed with organic fertilizer. N-Lock application was made within 10 days before or after nitrogen application. N-Lock was

incorporated into the soil either mechanically or through precipitation/irrigation (15 mm water within 10 days after application).

### Measured factors

Depending on the location the following values were collected: chlorophyll-index in leaves; Nmin values in the soil during vegetation and after harvest; crop performance and yield; nitrogen losses through leaching and greenhouse gases emissions. The gases were collected in chambers and then concentration measured using gas-chromatograph equipment.

### RESULTS AND DISCUSSION

Data collected from trials across Europe showed that N-Lock influenced chlorophyll index in leaves, crop grain yield (Table 1), nitrogen retention in root zone and nitrate leaching to the groundwater.

*Table 1. Impact of N-Lock application on yield increase in corn and winter oilseed rape grain with number of observations (n)*

Crop	n	Yield untreated (t/ha)	Yield treated with N-Lock (t/ha)	Yield increase (%)
Grain corn	68	10,27	10.83	7,1
Winter oilseed rape	42	3.92	4.05	4.2

### CONCLUSION

Based on large number of trials it can be concluded that the application of N-Lock at 2,5 l/ha (nitrapyrin at 500 gai/ha) impacts following factors: (1) increases chlorophyll index in leaves, (2) increase yield of grain corn and winter oilseed rape, (3) nitrogen stays longer in the root zone available for the crops, (4) N-min values in the soil are higher and more stable, (5) nitrate leaching to the groundwater is decreased and (6) greenhouse gases emissions were reduced.

™ Trademark of The Dow Chemical Company (“Dow”) or an affiliated company of Dow.

### REFERENCES

- Wolt J., 2004. A meta-evaluation of nitrapyrin agronomic and environmental effectiveness with emphasis on corn production in the Midwestern USA, *Nutrient Cycling in Agroecosystems* 69: 23-41.
- International Plant Nutrition Institute: Nutrient Source Specific No. 26:  
[http://www.ipni.net/publication/nss.nsf/0/21B8084A341C98E085257E3C0077595B/\\$FILE/NSS-26%20Nitrification%20Inhibitors.pdf](http://www.ipni.net/publication/nss.nsf/0/21B8084A341C98E085257E3C0077595B/$FILE/NSS-26%20Nitrification%20Inhibitors.pdf)  
[https://www.nitrogenmaximizers.com/maximizemanure/?utm\\_source=maximize\\_manure&utm\\_medium=redirect&utm\\_campaign=Vanity%20URL](https://www.nitrogenmaximizers.com/maximizemanure/?utm_source=maximize_manure&utm_medium=redirect&utm_campaign=Vanity%20URL)

## MAINTAINING SOIL NITROGEN AND CARBON STOCKS IN LONG-TERM GRASSLAND EXPERIMENTS IN NORWAY

STURITE I., OPSTAD S.

Norwegian Institute of Bioeconomy, Norway

### INTRODUCTION

More than 90 % of crops grown on Norwegian soils are turned into food through animal production systems, making perennial forage production one of the main pillars of Norwegian food production. To maintain high productivity, grasslands are subjected to different management practises such as frequently renovation by ploughing and reseeding together with the addition of inorganic or organic fertiliser. However, in Norway, a significant amount of swards are more than 10 years old. The choice of management practice can influence soils' ability to store and cycle carbon (C) and nitrogen (N) (Bellamy et al. 2005; Heyburn et al. 2017). The objective of presented study was to assess whether age of grassland and fertilisation practises affect C and N content in soil.

### MATERIAL AND METHODS

In Norway, one experimental site has been maintained since 1968 (Særheim Research Station in southwest (SW) Norway (58°47'N 5°41'E) and the second experimental site since 1974 (SW Norway at Fureneset Research Station (61°18'N 5°4'E)). These are the oldest, ongoing fertilisation experiments on grassland in Norway that include long-term/permanent (no-tillage almost 20 and 40 years) next to short-term leys reseeded every 3<sup>rd</sup> and 6<sup>th</sup> year. Both sites have a costal climate with mild winters and rainy summers. Soil at both sites is a sandy loam of moraine origin. The grass seed mixture (timothy, meadow fescue and smooth grass) was used when establishing both the permanent and reseeded 6- years swards while pure perennial ryegrass is used in 3-years sward. Since 1992 two levels of N have been applied during the growing season either in form of mineral N or as the cattle slurry (OF) in combination with mineral fertiliser (MF). Annually, permanent and 6-years old swards received 185 or 260 kg ha<sup>-1</sup> of N at Fureneset and 190 or 270 kg ha<sup>-1</sup> of N at Særheim. Corresponding values of N inputs in 3-years old swards were 245 and 295 kg ha<sup>-1</sup> at Fureneset and 250 and 330 kg ha<sup>-1</sup> at Særheim. The plant biomass of long-term and 6-years old swards were harvested two times per year and the biomass of 3-years old swards were harvested three times during the growing season. Herbage yields were determined on each cut. The experiments were arranged in a strip-split-block design. Soil samples were collected from all treatments in the end of the growing season in 2009 using a 2.5 cm soil corer to a depth of 0-5 cm, 5-20 cm and 20-40 cm. The samples were analysed for total C and N (g/100g dry matter) content. The relation between C and N content in soil horizons of different age grasslands and fertilisation practises was tested statistically by linear regression.

### RESULTS AND DISCUSSION

The total soil N content measured in different soil depth was a highly linearly correlated with the total soil C content at the corresponding soil depth regardless of sward age and fertilisation practise (Table 1 and Fig.1 A, B). Heyburn et al (2017) also found significantly positively relation between soil C stocks and soil N content in 22-years old grasslands. At both experimental locations, the content of soil N and C was significantly higher at the depth of 0-5 cm than at the depth of 20-40 cm ( $P < 0.0001$ ). Only at Fureneset (Fig.1 A) the both long-term grassland treatments had significantly larger soil N and C content in upper soil horizon than frequently ploughed and reseeded grasslands. Despite the same soil type, plant botanical composition and management practises at both sites, the N and C content in soil tended to be higher at Fureneset (Fig.1 A) than at Særheim (Fig.1 B). Application method of nutrients and fertiliser level had no influence on N and C stocks over the entire 17 years period.

Table 1. Mean total soil carbon and nitrogen content ( $\text{g } 100 \text{ g DM}^{-1}$ ) in the different soil depths of long-term and short-term grasslands at Særheim and Fureneset in 2009.

TREATMENT	SÆRHEIM						FURENESET					
	TOT C			TOT N			TOT C			TOT N		
SOIL DEPTH, CM	0-5	5-20	20-40	0-5	5-20	20-40	0-5	5-20	20-40	0-5	5-20	20-40
40-YEARS SWARD	6.6	4.8	2.6	0.46	0.27	0.14	11.7	9.6	5.2	0.64	0.54	0.29
20-YEARS SWARD	5.8	4.3	2.5	0.30	0.25	0.15	10.5	8.5	5.5	0.59	0.45	0.26
6-YEARS SWARD	5.1	4.9	3.0	0.30	0.28	0.17	8.6	7.8	4.1	0.47	0.40	0.21
3-YEARS SWARD	5.2	4.6	3.1	0.29	0.27	0.16	8.4	7.8	4.7	0.45	0.42	0.23

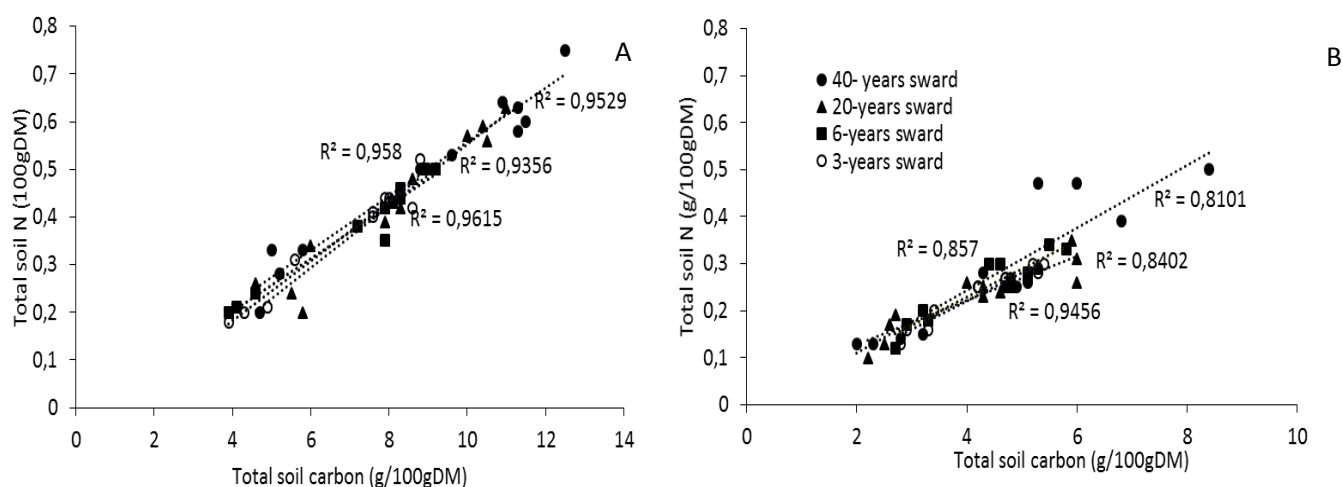

Figure 1. Relationship between total soil N and total soil C in long- and short-term grasslands at Fureneset (A) and at Særheim (B). Mean of each fertiliser type and each fertiliser level.

## CONCLUSION

A highly significantly linear relationship was found between N and C content in soils of long- and short-term grasslands, suggesting that C and N biogeochemical cycles are influenced from each other. In one of the two experimental sites almost 20 and 40 years old grasslands stored significantly more N and C in upper soil horizon (0-5 cm) than reseeded grasslands every 3<sup>rd</sup> and 6<sup>th</sup> year. Regardless of grassland age, no differences were found between the nutrient application levels and the methods used on the N content in any of soil horizons.

## REFERENCES

- Bellamy P.H., Loveland P.J., Bradley R.I., Lark R.M., Kirk G.J., 2005. Carbon losses from all soils across England and Wales 1978-2003. *Nature*, 437: 245-248.
- Heyburn J., McKenzie P., Crawley M.J., Fornara D.A., 2017. Effects of grassland management on plant C:N:P stoichiometry: implications for soil element cycling and storage. *Ecosphere*, 8 (10): 1-14.



## **NITROGEN LEACHING AFTER SOLID MANURE APPLICATION IN AUTUMN BEFORE SPRING SOWING**

DELIN, S.<sup>1</sup>

<sup>1</sup> Swedish University of Agricultural Sciences, Sweden

### **INTRODUCTION**

Regulation of manure application in autumn due to risk for leaching can be problematic for manure rich in straw that could be unbeneficial for the crop to apply close to sowing and on clay soils that cannot be ploughed in spring. The risk for leaching is likely to differ between different soil texture and manure characteristics.

### **MATERIAL AND METHODS**

In 80 cm deep lysimeters (Persson & Bergström, 1991) with loamy sand or silty clay, manure was applied in October, November or March during three consecutive years before sowing spring oats (2014 and 2016) or spring barley (2015). Nitrogen (N) leaching measurements started before the first manure application in October 2013 and continued until the end of the year 2017. On sandy loam, manure with high or low Carbon:Nitrogen ratio (C:N=18 or 10) was compared for all times of application. On silty clay, application of manure with low C:N ratio in October and November was compared. There was also one control treatment with no manure application for each soil type. The experiments were conducted in an outdoor facility in Sweden. All treatments had three replicates with in total nine lysimeters with silty clay and 21 lysimeters with loamy sand. The treatments were kept in the same lysimeters for all three years. In parallel field plot experiments, effects on ammonia emissions and grain yield were measured. In addition, soil samples were taken in autumn and early spring in the layers 0-30 cm, 30-60 cm and 60-90 cm and analysed for ammonium and nitrate nitrogen. The field experiments were located at the same sites as where soil was collected for the lysimeters and had the same treatments in three replicates plus two additional treatments with different mineral nitrogen fertiliser additions. In parallel incubations, net nitrogen mineralisation depending on manure C:N ratio was studied for fifteen different solid manures in loamy sand and for the two manures used in lysimeter and field experiment on the silty clay. The incubations were performed in the laboratory at 10°C.

### **RESULTS AND DISCUSSION**

Nitrogen leaching was not affected by timing of manure application, when manure C:N ratio was 18. However, when C:N ratio was 10, nitrogen leaching was elevated with around 10 kg N per ha after manure application in October compared to November and March (Figure 1). One year after manure application, no significant differences in nitrogen concentration between treatments were observed, which indicates no significant residual effects of manure application on N leaching during the following year. The grain yield in the parallel field experiments was similar between application times of manure, but tended to be lower after application of manure with high C:N ratio in March and after application of manure in November on clay soil. Ammonia emissions did not differ between manure types, but were on average higher after application in October when air temperature was on average 12°C compared to in November and March when air temperature was on average 5°C. Incubation results indicated that only manure with C:N ratio below 14 tended to release enough mineral N to be considered as risk for leaching during the first months after application, which is in accordance with other similar investigations (Qian & Schoenau, 2002). The effects of manure application on leaching were similar between the two soil types in the lysimeter study. However, the soil analyses from the field experiments indicated no effects of manure application on leaching on the silty clay, only on the loamy sand. This difference in results between field and lysimeters for the silty clay could be explained by moister soil conditions in the field, leading to larger losses with denitrification rather than by leaching.

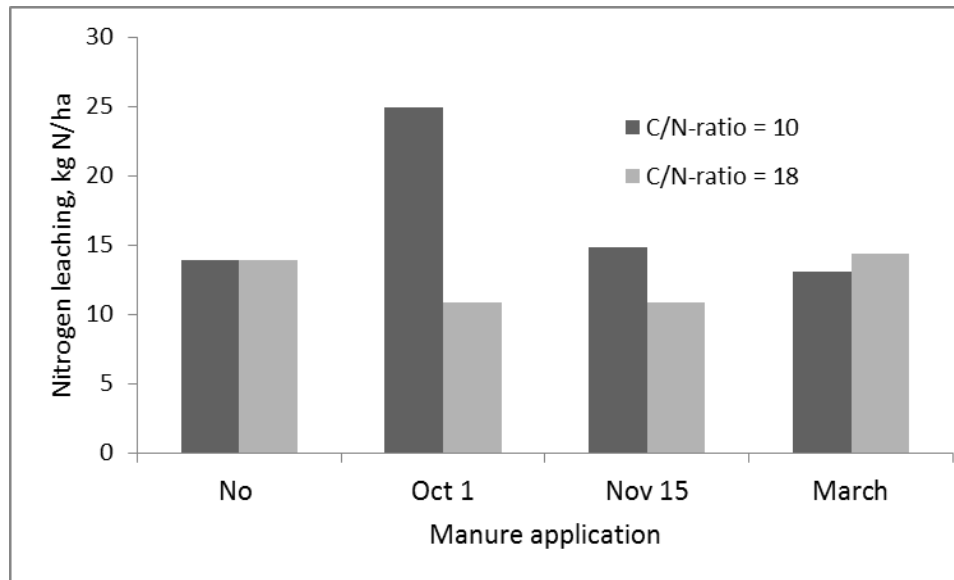

Figure 1. Yearly nitrogen leaching depending on time for application of solid manure before spring sowing on the loamy sand.

#### CONCLUSION

Nitrogen leaching after application of manure was unaffected by time for application for manure with high (>14) C:N ratio, whereas for manure with low C:N ratio (<14) application in October caused higher N leaching than application in November and March.

**Acknowledgements:** This project was financed by Formas. The author wish to thank all of those who helped performing the experiments and all who gave valuable advice, including Ingrid K Thomsen and Lars Bergström. Special thanks to Rolf Tunared who built the lysimeter facility.

#### REFERENCES

- Qian, P. Schoenau, J.J. 2002. Availability of nitrogen in solid manure amendments with different C:N ratios. Canadian Journal of Soil Science 82, 219-225.
- Persson, L. Bergström, L. 1991 Drilling method for collection of undisturbed soil monoliths. Soil Sci Soc Am J 55, 285-287.

## HUMAN URINE AS A NITROGEN FERTILIZER: A GREENHOUSE EXPERIMENT

MARTIN, T.M.P.<sup>1,2</sup>, LEVAVASSEUR, F.<sup>1</sup>, ESCULIER, F.<sup>2,3</sup>, HOUOT, S.<sup>1</sup>

<sup>1</sup> ECOSYS, INRA, AgroParisTech, Université Paris-Saclay, 78850, Thiverval-Grignon, France; <sup>2</sup> LEESU, ENPC, UPEC, AgroParisTech, Université Paris-Est, 75455 Marne-la-Vallée Cedex 2, France; <sup>3</sup> METIS, Sorbonne Universités, CNRS, EPHE, 75005 Paris, France

### INTRODUCTION

Urine source separation is a promising paradigm for the development of a sustainable urban metabolism. Today, recycling of nutrients from wastewaters on crops is low. Only 4 % of the nitrogen and 41 % of the phosphorus present in the wastewater of Paris urban area are recycled according to Esculier et al., 2018. On the other hand, N injected into agricultural systems comes mostly from highly energy-consuming processes and phosphorus is a fossil resource for which the peak production may be reached in the next decades (Cordell et al., 2009). N fertilizers consumption and almost all the P consumption in the Ile-de-France region could be covered by the excretions of the Paris urban area inhabitants (Esculier et al., 2018). This valorization is especially possible via the urines, which contains most of these nutrients (about 75% of the N and 50% of the P loads in domestic wastewater according to Eme and Boutin, 2015) in a small volume. Treatments can be done on urine in order to obtain different types of products: liquid, solid, concentrated ... (e.g. nitrification permits to avoid ammonia volatilization and allows concentration of nutrients by distillation). Few studies exist on urine based fertilizer, although some authors have found a higher fertilizing potential than organic fertilizer and similar to mineral fertilizer (Kirchmann and Pettersson, 1995). The aim of this work was thus to characterize the N use efficiency of such products.

### MATERIAL AND METHODS

A greenhouse pot experiment was carried out during 56 days with English ryegrass (*Lolium Perenne*). The experiment included 6 treatments corresponding to 5 organic products and a mineral N treatment: urine (U), nitrified concentrated urine (NCU), cattle slurry (CS), compost (C), compost mixed with urine (C+U) and mineral nitrogen solution (MNS). The cattle slurry was used as a reference for classical organic fertilizer used by farmers. We tested a mix between urine and compost as it could be done easily on composting platform and could increase the mineral nitrogen content in compost. Mix was done just before the beginning of the experimentation using 20 g of compost for 16.7 g of urine. The products were mixed with 1.3 kg of loam soil just before the seeding of ryegrass. Each product was tested for two doses (X and Y, only Y for compost because of the low nitrogen availability), plus an unfertilized control treatment.

*Table 1. Product characteristics (mean value and [standard deviation]): pH, dry matter content (DM), total (Tot-N) and mineral (Min-N) nitrogen concentrations, phosphorus (P<sub>2</sub>O<sub>5</sub>) and potassium (K<sub>2</sub>O) concentrations. Treatment input in soil: dose, total (Tot-N input) and mineral nitrogen input (Min-N input) for the different products: urine (U), nitrified concentrated urine (NCU), cattle slurry (CS), compost (C), compost mixed with urine (C+U) and mineral nitrogen solution (MNS).*

Product	Product characteristics						Treatment input in soil		
	pH	DM %	Tot-N g.L <sup>-1</sup> /g.kg <sup>-1</sup> *	Min-N g.L <sup>-1</sup> /g.kg <sup>-1</sup> *	P <sub>2</sub> O <sub>5</sub> g.L <sup>-1</sup> /g.kg <sup>-1</sup> *	K <sub>2</sub> O g.L <sup>-1</sup> /g.kg <sup>-1</sup> *	Dose	Tot-N input mg.kgMS <sup>-1</sup>	Min-N input mg.kgMS <sup>-1</sup>
U	9.1	1.6	6.6	5.5	0.4	2.3	X	131.4	108.5
	[0.0]	[0.5]	[0.0]	[0.1]	[0.0]	[0.1]	Y	262.7	216.9
NCU	3.9	X	66.2 <sup>1</sup>	66.2	10.7	50.6	X	120.6	120.6
	[0.0]			[5.5]	[0.2]	[1.8]	Y	241.4	241.4
CS	8.0	12.0	6.0*	1.4*	3.1*	3.8*	X	184.0	42.2
	[0.2]	[0.1]	[0.1]	[0.0]	[0.1]	[0.1]	Y	368.1	84.5
C	8.8	74.1	14.3*	0.2*	5.2*	9.8*	Y	684.9	10.0
	[0.1]	[0.8]	[0.4]	[0.0]	[0.2]	[0.1]			
C+U	X	41.1 <sup>1</sup>	10.8 <sup>1</sup> *	3.1 <sup>1</sup> *	3.3*	7.3*	X	473.5 (131.4 from U)	113.5 (108.5 from U)

					[0.5]	[1.0]	Y	947.1 (262.7 from U)	226.9 (216.9 from U)
MNS	4.7	0	222	222	0	0	X	77.8	77.8
	[0.0]		[6.2]	[6.2]			Y	155.6	155.6

<sup>1</sup>Estimated values. Org N was neglected for NCU. For C+U, DM, Tot-N, Min-N were estimated with the ratio mix of U and C.

The experiment included 52 pots: 13 treatments and 4 replicates. The pots were randomized and moved every week to avoid heterogeneous radiation. Temperature (17 °C to 23 °C) and soil humidity (90 % to 100 % of field capacity) were controlled. When leaching occurred, the leachates were recovered and put back on the corresponding pots to avoid mineral nitrogen losses. The above ground biomass was cut 21, 40 and 56 days after the beginning of the experiment. Fresh and dried biomasses were weighed and nitrogen content was analyzed by Dumas method. The nitrogen use efficiency (NUE) was calculated as the slope of the relationship between plant nitrogen uptake and applied nitrogen doses including the control. NUE for C+U was calculated using only nitrogen from U as applied nitrogen dose. An ANOVA was performed using R to determine significant differences among treatments: ANOVA followed by Tukey HSD or Kruskal-Wallis test followed by Willcoxon-Mann-Whitney test.

## RESULTS AND DISCUSSION

Under the conditions of the experiment, the NUE of the raw urine (U) or treated urine (NCU) were close to, or even higher than that of the mineral fertilizer (MNS). The larger proportion of mineral N in these products (83% for U, 100% [estimated] for NCU) compared to cattle slurry (23% of mineral nitrogen) permitted a higher assimilation of nitrogen than with this conventional organic fertilizer. The higher NUE for U and NCU than for mineral fertilizer could be explained by the supply of other nutrients with these products (e.g., 0.6 for U to 1.6 for NCU grams of phosphorus and 3.5 for U to 7.6 for NCU grams of potassium for 10 grams of nitrogen), and by a buffering capacity which helped to maintain a higher soil pH. When applied with compost, the NUE of urine was slightly reduced due to mineral nitrogen organization of some of the mineral nitrogen in the urine, but remained good (about 85% of that of urine alone) in addition to being an amendment.

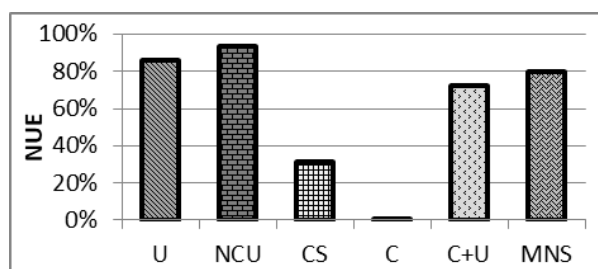

Figure 1. Nitrogen use efficiency (NUE) according to the product and calculated for dose X and Y (only Y for compost): urine (U), nitrified concentrated urine (NCU), cattle slurry (CS), compost (C), compost mixed with urine (C+U), mineral nitrogen solution (MNS).

## CONCLUSION

Urine based products are a promising new source of nitrogen fertilization in agriculture. The implementation of alternative sanitation systems can also lead to great environmental and social benefits: decreases in energy consumption, reductions in greenhouse gases emissions, improvement in surface water quality, sustainable nutrient source and reconnection of urban and rural territories. The work is going on with complementary experiments to study the innocuousness of such new source of nitrogen and the potential environmental impacts through gas emissions after application.

**Acknowledgements:** We thank the OCAPI project and the Ile-de-France Federation for Research on the Environment (FIRE) for their financial support.

**REFERENCES**

- Cordell, D., Drangert, J.-O., and White, S., 2009. The story of phosphorus: Global food security and food for thought. *Glob. Environ. Change* 19, 292–305.
- Eme, C. and Boutin, C., 2015. Composition des eaux usées domestiques par source d'émission à l'échelle de l'habitation. IRSTEA, ONEMA, CréaPure Éd.
- Esculier, F., Le Noë, J., Barles, S., Billen, G., Creno, B., Garnier, J., Lesavre, J., Petit, L., Tabuchi, JP., 2018. The biogeochemical imprint of human metabolism in Paris Megacity: a regionalized analysis of a water-agro-food system. *J. Hydrol.*
- Kirchmann, H., and Pettersson, S., 1995. Human urine-chemical composition and fertilizer use efficiency. *Fertil. Res.* 40, 149–154.

## **NUTRIENT CYCLING IN GRASSLAND SYSTEMS; N, P AND C CYCLING IN A PLOT EXPERIMENT ON THE NORTH WYKE FARM PLATFORM**

LE COCQ, K.<sup>1</sup>, MCAULIFFE, G.<sup>1,2</sup>, HORROCKS, C.<sup>1</sup>, DARCH, T.<sup>1</sup>, TAKAHASHI, T.<sup>1,2</sup>, BLACKWELL, M.<sup>1</sup>, MISSELBROOK, T.1, LEE, M.R.F.<sup>1,2</sup>, CARDENAS, L.<sup>1</sup>

1 Rothamsted Research, North Wyke, Okehampton, Devon, EX20 2SB, United Kingdom; 2 University of Bristol, Bristol Veterinary School, Langford House, Langford, Somerset, BS40 5DU.

### **INTRODUCTION**

While our understanding of N cycle contribution to greenhouse gas (GHG) emissions from grasslands is increasing, datasets which elucidate the influence of urine and manure deposits from grazing cattle on N cycling, microbial populations and GHG emissions are less complete. Nutrient inputs to soil from grazing cattle are spatially variable and therefore it is difficult to capture information about the specific effect of urine and dung deposits on the soil chemistry and microbial community from these events over different periods of time. The North Wyke Farm Platform (NWFP) provides the opportunity to study GHG emissions concomitantly with soil nutrient cycling under three different grassland management scenarios (farmlets); permanent pasture (PP), white clover + perennial ryegrass mix with no N fertiliser added (WC) and high sugar perennial ryegrass monoculture (HS). Here, we report the results of a plot experiment assessing the impact of bovine dung and urine deposits on N, P and C cycling in grassland on the three aforementioned grassland management systems, with a focus on N.

### **MATERIAL AND METHODS**

#### **Experimental design**

Plots measuring 2 x 1 m on three representative fields of the NWFP farmlets were treated with: synthetic urine (standard composition across all fields), cattle urine, dung, a fertiliser N control (as ammonium nitrate) and a zero N control. Cattle urine and dung treatments were collected and bulked within NWFP farmlets and only reapplied to their farmlet of origin. No fertiliser N was applied to the plots on the WC farmlet. Each plot was replicated three times on each field in a randomised block design. The same volume of each treatment was applied and samples were taken to determine the N content of each of the treatments on the day of application. Baseline data for gas emissions, soil chemistry, nucleic acid and herbage were taken before application of the treatments in June 2017. Following application of treatments, GHG emissions (N<sub>2</sub>O, CO<sub>2</sub> and CH<sub>4</sub>) were measured weekly. Soil samples were collected seven times following application of the treatments from each plot until the final sampling on 10/10/2017.

#### **Sample collection and analysis**

Greenhouse gas emissions were measured using a static chamber technique, as described in Cardenas *et al.* (2016), using 2 chambers per plot. For soils, 10 cm deep cores from three points randomly selected from a grid within each plot were combined to make one composite sample per plot. The samples were stored at 4°C until processing upon which any plant material was removed, and the soils were crumbled and homogenised. 50 g were subsampled for potassium chloride (KCl) extractions and subsequent analysis of reactive N, and the remaining soil was frozen. Wet weight of the samples was recorded before freeze drying. Dried weights were taken and the % moisture was determined gravimetrically. A sterile cork borer was used to take 8 cores for microbial analysis from each plot and immediately flash frozen in liquid N on site and subsequently stored at -80 °C prior to analysis.

Soil and dung samples were analysed for total N, P, C as well as iodine, selenium, potassium, molybdenum and manganese following standard laboratory procedures. Herbage was sampled twice during the experiment following treatment and analysed for yield, micronutrient content and total N, P and C. Data were analysed using

analysis of variance (ANOVA) to test for statistical differences between experimental treatments. GenStat (VSNi, 2017) was used to carry out all statistical tests. Microbial genes involved in N cycling will be quantified using qPCR. Cumulative values for N<sub>2</sub>O fluxes were log transformed and analysed for probability of statistical significance with ANOVA.

## RESULTS AND DISCUSSION

Preliminary results showed a significant difference in total N<sub>2</sub>O fluxes between NWFP farmlets (P=0.022). Preliminary soil N analysis results showed that soil TON content followed the same trend across NWFP farmlets but differences were observed between the experimental treatments. Full results of soil C, P and N content will be presented following complete analysis.

## CONCLUSION

Conclusions based on preliminary results are that the forage diet of grazing cattle have a significant influence on the GHG emissions and N cycling following dung and urine deposition. Further conclusions will be drawn following full analysis of the experimental results.

**Acknowledgements:** This work was supported as part of Rothamsted Research's Institute Strategic Programme – Soil to Nutrition (BBS/E/C/00010320) funded by the UK Biotechnology and Biological Sciences Research Council. The North Wyke Farm Platform is a UK National Capability supported by the Biotechnology and Biological Sciences Research Council (BBSRC BB/J004308/1).

## REFERENCES

- Cardenas, L.M., Misselbrook, T.M., Hodgson, C., Donovan, N., Gilhespy, S., Smith, K.A., Dhanoa, M.S. And Chadwick, D., 2016. Effect of the application of cattle urine with or without the nitrification inhibitor DCD, and dung on greenhouse gas emissions from a UK grassland soil. *Agriculture, ecosystems & environment*, 235, pp.229-241.
- Orr, R.J., Murray, P.J., Eyles, C.J., Blackwell, M.S.A., Cardenas, L.M., Collins, A.L., Dungait, J.A.J., Goulding, K.W.T., Griffith, B.A., Gurr, S.J. And Harris, P., 2016. The North Wyke farm platform: effect of temperate grassland farming systems on soil moisture contents, runoff and associated water quality dynamics. *European journal of soil science*, 67(4), pp.374-385.
- VSN International (2017). GenStat For Windows 19th Edition. VSN International, Hemel Hempstead, UK. Web page: [genstat.co.uk](http://genstat.co.uk)

## THE IMPACTS OF SOIL INCORPORATION OF CONVENTIONAL AND NOVEL ORGANIC FERTILIZERS ON N AVAILABILITY AND MICROBIAL PARAMETERS

GEBREMIKAEL, M.<sup>1</sup>, RANASINGHE, A.<sup>2</sup>, SALEHI, P.<sup>1</sup>, PIPAN, M.<sup>3</sup>, DE NEVE, S.<sup>1</sup>

<sup>1</sup> Ghent university, Belgium; <sup>2</sup> University of Kelaniya, Sri Lanka; <sup>3</sup> Entomics Biosystems Ltd, UK

### INTRODUCTION

In addition to the conventional organic inputs into the soil, numerous new materials have become available during the last decades following novel agricultural industries, applications and processes. A rapid increase of such agricultural waste co-products and by-products (AWCB) is posing a threat to the environment. The need for sustainability and increasing agricultural productivity to feed the growing world population calls for treating, recycling and valorising AWCB in a sustainable way. **Agrocycle**, an EU funded project under H2020 research and innovation program, aims to provide mechanisms to achieve a 10% increase of the recycling and valorisation of agricultural waste by 2020, and to maximize the use of by-products and co-products via the creation of new sustainable value chains.

One of the mechanisms in this regard is the use of AWCB as a soil amendment and biofertilizer. Accordingly, we (together with other Agrocycle partners) develop and test the potential and sustainability of existing AWCB and new biofertilizers (BF) as soil organic matter amendment and N sources for crop production.

For a sustainable use of these organic materials, knowledge on their agricultural value and environmental risk is needed for farmers and policy makers. We conducted two incubation experiments using 11 conventional and novel organic fertilizers (OF) spanning a wide range of C:N ratio (6.5:1-60:1), consistency (liquid and solid) and sources (digestates, crop residues, phytoremediation plants and oil industry and food wastes). This abstract presents the N availability from the AWCB and BF, and shows an overview of impacts of these materials on microbial biomass and enzyme activity in the soil.

### MATERIAL AND METHODS

Soil samples were collected from 0-15cm of an organically managed maize field at Rumbeke, Belgium. After drying and sieving, samples were preincubated for 10 days, and filled into PVC tubes (h=10 cm, r=5 cm). Because of the large differences in C:N, it was not practical to apply a rate based on the same C or N content. The list of AWCB applied at field rates are: Anaerobic digestates of various feedstocks such as cattle manure only (AD\_Man), AD from cattle slurry activated with crop residues (ActivatedAD), crop residues (AD\_Crop), and pig slurry-crop residue mixture (AD\_PigCrop). Other OF include: Composts from rice bran (RB compost), olive prunings (OliveW Compost), municipal wastes (MW Compost); Phytoremediation plant biomass (PhytoR), fresh crop residues of wheat (W-straw), sugar beet (SugarbtR), and a novel biofertilizer frass (insect poo and leftover collected during the larval growth of an insect on mixed food waste). Two separate incubation experiments were conducted at constant temperature and moisture content. Samples were destructively removed from each treatment at six sampling points during 120-147 days long incubation. Mineral N and other biological parameters including enzymes, microbial biomass C and PLFA were measured at each sampling time.

### RESULTS AND DISCUSSION

The percentage of N mineralized from the AWCB and BF varied over time (Figure 1). Based on the results of the incubation experiment, the AWCB and BF can generally be categorized into three groups in relation to their potential to N mineralization. The first group, particularly wheat straw, municipal waste compost and olive waste composts resulted in no net N mineralisation during the entire period of the incubation. The second group such as sugar beet residue and the general food waste frass did not result in net N mineralisation until 30 and 90 days



of the incubation, respectively. A significant percent of N ranging from 9% to 68% was mineralized from the remaining AWCB and BF during the entire period of the incubation.

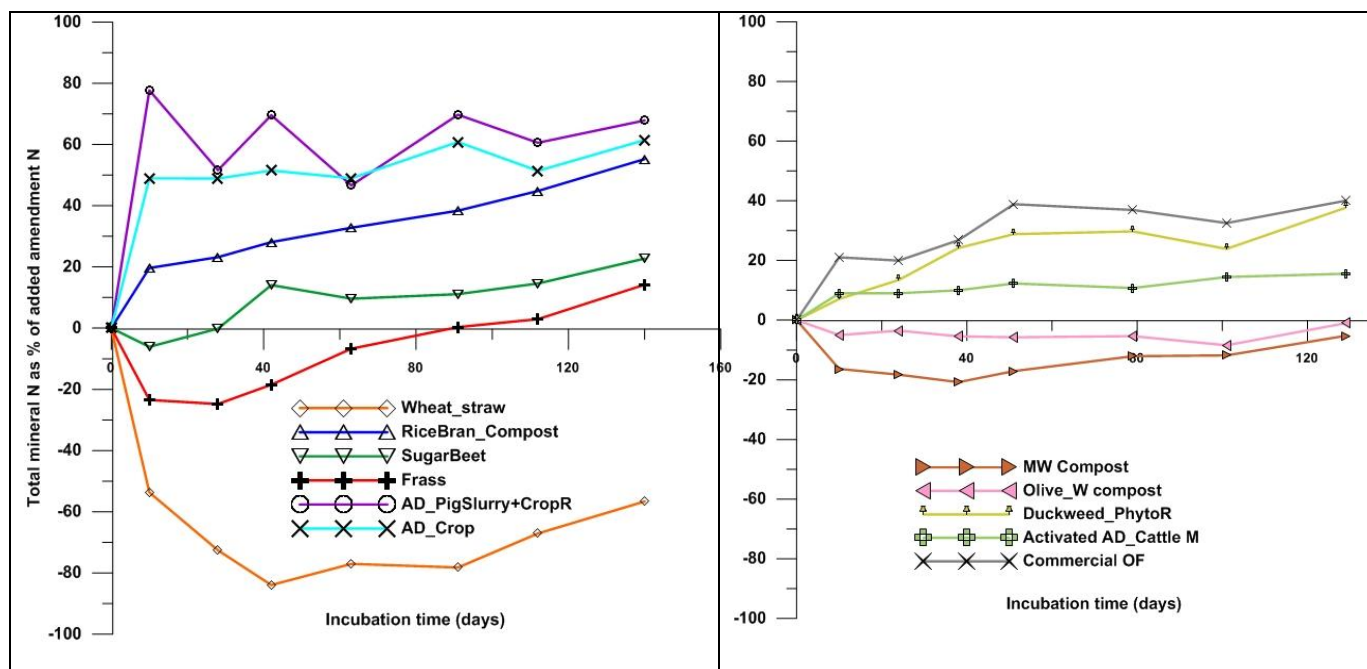

Figure 1. The evolution of total mineral N expressed as % of total N added in the amendment.

The application of these materials significantly enhanced biological quality parameters, particularly microbial biomass C and enzymatic activities (both dehydrogenase and betaglucosidase activities). AWCB and BF with relatively higher C:N ratio such as wheat straw, frass and the three composts (MWC, OliveWC, Ricebran compost) resulted in higher dehydrogenase enzyme activities compared to the one with lower C:N ratio such as digestates during the initial period of the experiment. The differences amongst the AWCB and BF became less pronounced towards the end of the incubation experiment suggesting that the impacts of these materials on intracellular biological soil quality parameters are only short-term.

## CONCLUSION

The data on the evolution of N mineralization-immobilization dynamics has important implication for synchronization of plant N need with the release of N from the AWCB and BF to maximize crop production. The data can also be used to categorize these materials as a soil amendment, immobilizing materials or biofertilizer. Frass has a potential to be used as biofertilizer and probably as immobilizing material in a similar way that catches crops are applied.

**Acknowledgements:** The materials investigated are provided by partners of the Agrocycle project (CREA-Italy; Demeter-Greece; AGRii-UK and INAGRO-Belgium). This project has received funding from the European Union's Horizon 2020 research and innovation programme under grant agreement N° 690142.

# 20<sup>th</sup> Nitrogen Workshop

## Coupling C-N-P-S cycles

June 25-27, 2018  
Le Couvent des Jacobins, Rennes – France

### **Session III: Local process studies – Posters**

## **SUBSTITUTION OF UREA BY CALCIUM AMMONIUM NITRATE IN A RAINFED SEMI-ARID CROP: EFFECT ON N OXIDES EMISSIONS, YIELD AND QUALITY**

GUARDIA, G.<sup>1</sup>; SÁNCHEZ-MARTÍN, L.<sup>1</sup>; SANZ-COBENA, A.<sup>1</sup>; RODRÍGUEZ DE QUIJANO, M.<sup>1</sup>; FUERTES-MENDIZÁBAL, T.<sup>2</sup>; GONZÁLEZ-MURUA, C.<sup>2</sup>, VALLEJO, A.<sup>1</sup>

<sup>1</sup> ETSI Agronómica, Alimentaria y de Biosistemas, Universidad Politécnica de Madrid (UPM), Spain, <sup>2</sup> Department of Plant Biology and Ecology, University of the Basque Country (UPV/EHU), Bilbao, Spain.

### **INTRODUCTION**

The use of calcium ammonium nitrate (CAN) instead of urea (U) can increase the emission of nitrous oxide (N<sub>2</sub>O), a powerful greenhouse gas (IPCC, 2014), in areas with predominance of denitrification (e.g. grasslands) (Roche et al., 2016). However, contrasting results have been found in semi-arid arid cropping systems (e.g. Mediterranean) with low organic C contents in soil and predominance of nitrification, even under irrigated conditions (Guardia et al., 2017; 2018). This experiment aimed to assess the effect of CAN and U on N<sub>2</sub>O and nitric oxide (NO) emissions, nitrogen (N) use efficiency (NUE), yield and breadmaking quality in a non-irrigated winter wheat crop (*Triticum aestivum* L.).

### **MATERIAL AND METHODS**

#### **Experimental design and management**

A field experiment was set up in central Spain (latitude 40°25'N, longitude 3°29'W) in an alkaline silty loam soil with a 2.1% of oxidizable organic matter (Walkley-Black). A randomized complete block design with three replicates was established. The treatments were U, CAN (which were applied in at a rate of 120 kg N ha<sup>-1</sup>) and control (C) which did not receive synthetic N fertilization. The N fertilizers were applied at top-dressing (26<sup>th</sup> February, tillering stage).

#### **N oxides sampling and analyses**

Gas samples were taken from February to July by the closed chamber technique and N<sub>2</sub>O was analyzed by Gas Chromatography. Nitric oxide was measured using a gas flow-through system by using a closed chamber and a chemiluminescence detector (Guardia et al., 2017).

#### **N efficiency, yield and breadmaking quality**

Wheat was harvested on 21<sup>st</sup> June with a research plot combine. Previously, the plants of one row were harvested to determine the total N content of grain and straw, which was analyzed using a TruMac CN Leco elemental analyzer. In addition, the SDS-sedimentation (SDSS) volume, which is highly correlated with were deformation energy and therefore with gluten strength, was determined as described by Callejo et al. (2016). Grain reserve proteins (gliadins and glutenins) were determined as described in Fuertes-Mendizábal et al. (2013). The NUE was calculated as the ratio between aboveground N uptake (subtracting that of C) and the amount of synthetic N applied. The N surplus was calculated as the N application minus the aboveground N uptake.

### **RESULTS AND DISCUSSION**

#### **N oxides emissions**

Both N<sub>2</sub>O and NO emissions peaked after N fertilization and were low from two months after fertilization to the end of wheat cropping cycle (and also before N fertilization). CAN decreased significantly both cumulative N<sub>2</sub>O (by 58%, Fig. 1a) and NO (by 69%, Fig. 1b) emissions. Our results were in agreement with Guardia et al. (2018), who

found that most N<sub>2</sub>O has been demonstrated to come from ammonium (NH<sub>4</sub><sup>+</sup>) oxidation rather from nitrate (NO<sub>3</sub><sup>-</sup>) reduction in a Mediterranean maize crop.

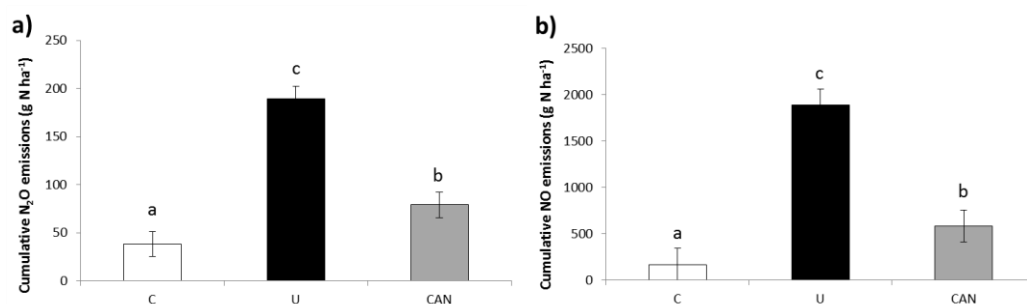

Figure 1. Cumulative N<sub>2</sub>O (a) and NO (b) emissions from fertilization to harvesting. Different letters within columns indicate significant differences by applying the Least Significant Difference (LSD) test at  $P < 0.05$ . Vertical bars indicate standard errors.

### Yield and breadmaking quality

We observed a positive response of wheat yield, protein content and SDSS volume to N fertilization. However, no significant differences were observed between U and CAN (which tended to increase grain N content and gluten strength), except for the gliadin to glutenin ratio. In comparison to U, CAN significantly increased NUE (by 29%) and decreased N surplus (by 49%).

### CONCLUSION

The substitution of U by CAN can be recommended to achieve an optimum balance between N oxides mitigation, yields, breadmaking quality and N efficiency in rainfed semi-arid cereal crops.

**Acknowledgements:** The authors are grateful to the Spanish Ministry of Economy and Innovation for their economic support through Project AGL2015-64582-C3-3-R (MINECO/FEDER). Funding for this research was also provided by EuroChem Agro GmbH.

### REFERENCES

- Callejo, M.J., Benavente, E., Ezpeleta, J.I., Laguna, M.J., Carrillo, J.M., Rodríguez-Quijano, M., 2016. Influence of teff variety and wheat flour strength on breadmaking properties of healthier teff-based breads. *J. Cereal Sci.*, 68, 38-45.
- Fuertes-Mendizábal, T., González-Torralba, J., Arregui, L.M., González-Murua, C., González-Moro, M.B., Estavillo, J.M., 2013. Ammonium as sole N source improves grain quality in wheat. *J. Sci. Food Agr.* 93, 2162-2171.
- Guardia, G., Cangani, M.T., Andreu, G., Sanz-Cobena, A., García-Marco, S., Álvarez, J.M., Recio-Huetos, J., Vallejo, A., 2017. Effect of inhibitors and fertigation strategies on GHG emissions, NO fluxes and yield in irrigated maize. *Field Crop. Res.* 204, 135-145.
- Guardia, G., Vallejo, A., Cardenas, L.M., Dixon, E.R., García-Marco, S., 2018. Fate of 15N-labelled ammonium nitrate with or without the new nitrification inhibitor DMPSA in an irrigated maize crop. *Soil Biol. Biochem.* 116, 193-202.
- IPCC, 2014. *Climate Change 2014: Synthesis Report. Contribution of Working Groups I, II and III to the Fifth Assessment Report of the Intergovernmental Panel on Climate Change* [Core Writing Team, R.K. Pachauri and L.A. Meyer (eds.)]. IPCC, Geneva, Switzerland, 151 pp.
- Roche, L., Forrestal, P.J., Lanigan, G.J., Richards, K.G.; Shaw, L.J., Wall, D.P., 2016. Impact of fertiliser nitrogen formulation, and N stabilisers on nitrous oxide emissions in spring barley. *Agr. Ecosyst. Environ.* 233, 229-237.

## NITROGEN AND PHOSPHOROUS AVAILABILITY OF ORGANIC FERTILIZERS- A GREENHOUSE STUDY

PALMBORG, C.<sup>1</sup>, HAHLIN A.-H.<sup>1</sup>

<sup>1</sup> Department of Agricultural Research for Northern Sweden, Swedish University of Agricultural Sciences, Sweden

### INTRODUCTION

Nutrient availability of organic fertilizers is traditionally determined by analysis of inorganic N and soluble P. However digestates can often have a large fraction of nutrients bound in bacteria. This fraction can also be easily available to plants. We have made a greenhouse study where simultaneous comparisons with increasing amounts of inorganic nitrogen and phosphorous was done to quantify the availability to barley of N and P in the organic fertilizers.

### MATERIAL AND METHODS

A 50/50 volume % mix of fine quartz sand and vermiculite was used as a substrate. Some 3 liter pots were filled to two cm from the top. The fertilizer was mixed with the upper half of the substrate and twelve barley seeds of the variety *Severi* were sown in each pot at 4 cm depth. The pots were watered to 60% of the water holding capacity three times a week. Ammonium nitrate and superphosphate was given in quantities corresponding to 10, 40 and 80 kg N ha<sup>-1</sup> and 1.9, 9.3 and 18.5 kg P ha<sup>-1</sup>. The organic fertilizers were; (i) liquid digestate (LD) from a dairy factory, (ii) solid granulates of digestate (SD) from a municipal sewage treatment plant and (iii) deep litter sheep manure that had either been stored indoors (MI) in the stable or (iv) outdoors (MO) in a heap during summer and autumn. The target amount of the organic fertilizers was 120 kg total N ha<sup>-1</sup> and the actual dose of N and P is shown in Table 1. The liquid digestate was also applied in a lower dose corresponding to 28 kg N ha<sup>-1</sup> and 7 kg P ha<sup>-1</sup> complemented with 80 kg of N ha<sup>-1</sup> as ammonium nitrate. A solution of K, Mg, S, Ca and micro nutrients was applied at the start of the experiment to all pots (modified from Antonini et al. (2012)). Each treatment was replicated in three pots that were placed on three different tables that changed position each week to ensure equal conditions for all plants. The temperature in the greenhouse was set to 15°C at night and 20°C at day and lamps with the light intensity of 170-200 micromoles m<sup>-2</sup> at table height were lit during 18 h per day when the natural light was not enough (<200 micromoles m<sup>-2</sup>). The logged temperature varied from 13.7 to 30.0°C with a mean of 20.6°C. After 93 days the plants were harvested, measured and separated into seeds and other aboveground biomass. The fertilizer equivalency of N was obtained by linear regression estimation of the amount of mineral fertilizer required to obtain the same aboveground biomass as the organic fertilizer.

Table 1. Dose of P given, C/N quotient and fertilizer equivalency of the organic fertilizers treatments.

Organic fertilizer		Kg total N ha <sup>-1</sup>	kg P ha <sup>-1</sup>	g kg <sup>-1</sup> fertilizer equivalent of N
Digestate	Liquid dairy waste <b>LD80</b>	80	21	0.85
	Liquid dairy waste <b>LD28N80</b>	27	7	n.d.
	Solid municipal sewage <b>SD127</b>	127	79	0.22
Sheep manure	Indoor storage <b>MI116</b>	116	20	0.17
	Outdoor storage <b>MO126</b>	126	25	0.09

### RESULTS AND DISCUSSION

The total dry matter yield of the different treatments is shown in figure 1. The yield of the mineral fertilizer treatments had a linear correlation to the N fertilization dose. However the **N80P9.3** had a significantly lower yield than the **N80P18.5**. This shows that there was some P-limitation to the growth when the P fertilization dose was halved, but the relation between P dose and yield was not linear. Both liquid and solid digestates had more available N than the inorganic N, while the sheep manures had a similar plant available N as the inorganic N (figure

1). The discrepancy between the amount of inorganic N in the fertilizer and the plant available N was largest for the liquid fertilizer from the dairy factory. The feedstock to this biogas plant was largely whey, a byproduct of cheese production rich in lactose. Thus the carbon source was easily degradable and the C/N quotient of the digestate was low. The availability of the P in the liquid digestate was approximately equivalent to superphosphate since the **LD28N80** that contained 7 kg of P had somewhat lower yield than the **N80P9.3**. The fertilizer equivalent value of N was higher in the digestates than the manures (Table 1).

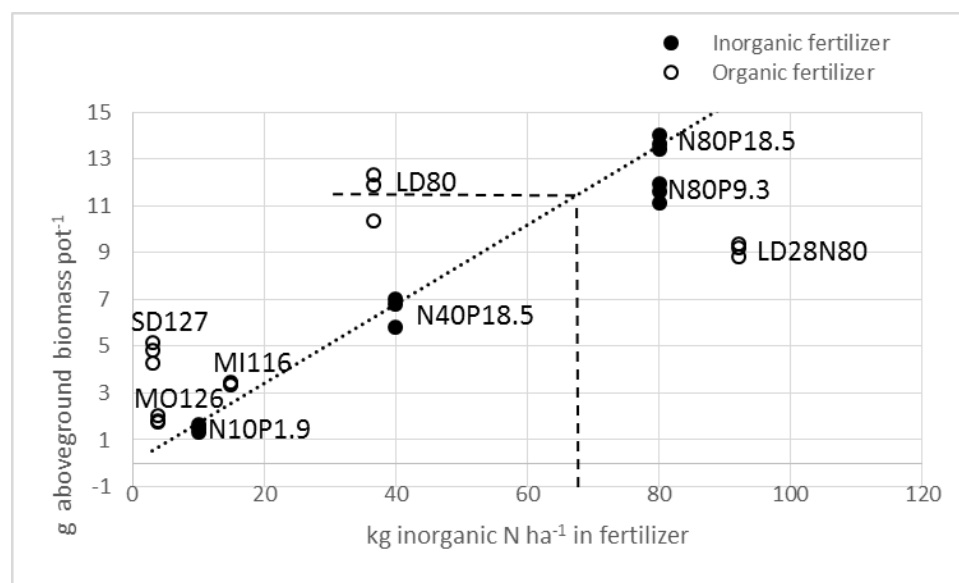

Figure 1. Yield of aboveground barley biomass in relation to the amount of inorganic N in the fertilizer. Treatments: **N10P1.9** 10 kg N in ammonium nitrate ha<sup>-1</sup> + 1.9 kg of P in superphosphate ha<sup>-1</sup>. **N40P18.5** 40 kg N in ammonium nitrate ha<sup>-1</sup> + 18.5 kg of P in superphosphate ha<sup>-1</sup>. **N80P18.5** 80 kg N in ammonium nitrate ha<sup>-1</sup> + 18.5 kg of P in superphosphate ha<sup>-1</sup>. **N80P9.3** 80 kg N in ammonium nitrate ha<sup>-1</sup> + 9.3 kg of P in superphosphate ha<sup>-1</sup>. **LD80** Liquid digestate 120 kg total N ha<sup>-1</sup>. **SD127** Solid digestate 120 kg total N ha<sup>-1</sup>. **LD28N80** Liquid digestate 40 kg total N ha<sup>-1</sup> + ammonium nitrate 80 kg N ha<sup>-1</sup>. **MO126** Sheep manure stored outdoor 120 kg total N ha<sup>-1</sup>. **MI116** Sheep manure stored indoor 120 kg total N ha<sup>-1</sup>. The linear regression for treatments used for determining of fertilizer equivalent of N is included as a dotted line. The calculation of the fertilizer equivalent of N is illustrated with dashed lines for **LD80**.

## CONCLUSION

The plant available N and P of organic fertilizers can be assessed simultaneously in greenhouse experiments, however the number of doses and range of the reference inorganic fertilisers need to be increased in order to quantify the fertilizer equivalency of P since the relationship between P dose and biomass yield was not linear.

**Acknowledgements:** This study was financed by Botnia Atlantica, Region Västerbotten, Regional Council of Ostrobothnia and the Swedish University of Agricultural Sciences (Ekoforsk).

## REFERENCES

Antonini S., Arias M., Eichert T., Clemens J., 2012. Greenhouse evaluation and environmental impact assessment of different urine-derived struvite fertilizers as phosphorus sources for plants. *Chemosphere*. 89, 1202-1210.

## IMPACT OF CONVENTIONAL TILLAGE AND NO-TILLAGE COVER CROPS ON NITROUS OXIDE EMISSIONS FROM VINEYARDS IN MEDITERRANEAN PORTUGAL

MARQUES, F.J.M.<sup>1</sup>, PEDROSO, V.<sup>2</sup>, TRINDADE, H.<sup>3</sup>, PEREIRA, J.L.S.<sup>1</sup>

<sup>1</sup> Polytechnic Institute of Viseu, ESAV, Quinta da Alagoa, Viseu, Portugal; <sup>2</sup> Direcção Regional de Agricultura e Pescas do Centro, CEVDão, Quinta da Cale, Nelas, Portugal; <sup>3</sup> University of Trás-os-Montes and Alto Douro, ECAV, Quinta de Prados, Vila Real, Portugal

### INTRODUCTION

Vineyards are cropped with different soil management practices such as cultivation, intermittent herbicide application, mulching and cover cropping. Nowadays, several agronomic and environmental advantages have been appointed to vineyard cover cropping such as water management, vine performance and soil conservation (Longbottom and Petrie, 2015; Garcia et al., 2018).

The aim this study was to assess the effect of conventional tillage and no-tillage cover crops on nitrous oxide (N<sub>2</sub>O) emissions from vineyards (*Vitis vinifera* L.) in Mediterranean Portugal.

### MATERIAL AND METHODS

A field study was carried out at the Dão Wine Research Station (latitude: 40.51°N, longitude: -7.85°W) located in central Portugal (Nelas, Portugal). The experiment was established in 2010 in a mature non-irrigated vineyard, planted with the Touriga Nacional red grape variety, and with a vine spacing of 1.1 m within and 2.0 m between rows. The experiment was a randomized block factorial design with three replications and four treatments. The following four treatments were considered in this study: (i) soil tillage (100 mm depth) of the inter-row (treatment: Till); (ii) soil tillage (100 mm depth) of the inter-row and application of mineral fertiliser (50 kg N ha<sup>-1</sup>) (treatment: Till+N); (iii) cover crop (permanent resident vegetation) in the inter-row (treatment: NoTill); (iv) cover crop (permanent resident vegetation) in the inter-row and application of mineral fertiliser (50 kg N ha<sup>-1</sup>) (treatment: NoTill+N). At Mars and June of each year, the soil tillage was performed with a cultivator mounted on a tractor whereas the resident vegetation was mowed with a brush cutter.

During two consecutive growing seasons of the grapevine crop (Mars to September of 2015 and 2016), the N<sub>2</sub>O fluxes were measured by the closed chamber technique and analysed by gas chromatography using a GC-2014 (Shimadzu, Japan). Additional information could be found in Marques et al. (2018). Data collected were analysed by analysis of variance and least-squares deviation tests were used for comparison of means by the software Statistix 7.0.

### RESULTS AND DISCUSSION

The results showed that the average direct N<sub>2</sub>O emission factor for vineyards managed with conventional soil tillage in the inter-row was 0.57±0.12% of nitrogen input and cover cropping by permanent resident vegetation in the inter-row reduces N<sub>2</sub>O emission in 60% (0.23±0.29% of nitrogen input) (Table 1). Thus, the vineyard cover cropping was recommended as mitigation measure in order to reduce N<sub>2</sub>O emissions.

The default direct N<sub>2</sub>O emission factor currently recommended by Intergovernmental Panel on Climate Change (IPCC) used by the Portuguese inventory was a generic fertiliser induced emission factor for agricultural crops (1% of nitrogen input). Thus, this study suggests that the N<sub>2</sub>O emissions from vineyards are currently potentially overestimated in the Portuguese inventory and recommends the use of a specific emission factor.

Table 1. Average direct nitrous oxide emission factors from the experiment (mean  $\pm$  standard deviation).

Treatment	N <sub>2</sub> O emissions (kg N ha <sup>-1</sup> season <sup>-1</sup> )	N <sub>2</sub> O emission factor (% of N input)
Till	0.25 $\pm$ 0.05 <sup>b</sup>	
Till+N	0.53 $\pm$ 0.11 <sup>a</sup>	0.57 $\pm$ 0.12 <sup>a</sup>
NoTill	0.24 $\pm$ 0.09 <sup>b</sup>	
NoTill+N	0.35 $\pm$ 0.07 <sup>ab</sup>	0.23 $\pm$ 0.29 <sup>b</sup>

Values from the treatment are presented with different superscripts within columns, are significantly different ( $p < 0.05$ ) by LSD test.

## CONCLUSION

The average direct N<sub>2</sub>O emission factor for vineyards managed with conventional soil tillage in the inter-row was 0.57 $\pm$ 0.12% of nitrogen input and cover cropping by permanent resident vegetation in the inter-row reduces N<sub>2</sub>O emission by 60%.

**Acknowledgements:** This study was funded by project POCI-01-0247-FEDER-003430 AMONIAVE.

## REFERENCES

- Garcia, L., Cellete, F., Gary, C., Ripoche, A., Valdés-Gómez, H., Metay, A., 2018. Management of service crops for the provision of ecosystem services in vineyards: A review. *Agriculture, Ecosystems and Environment* 251, 158-170.
- Longbottom, M.L., Petrie, P.R., 2015. Role of vineyard practices in generating and mitigating greenhouse gas emissions. *Australian Journal of Grape Wine Research* 21, 522-536.
- Marques, F.J.M., Pedroso, V., Trindade, H., Pereira, J.L.S., 2018. Impact of vineyard cover cropping on carbon dioxide and nitrous oxide emissions in Portugal. *Atmospheric Pollution Research* 9, 105-111.



## AMMONIA AND GREENHOUSE GAS EMISSIONS FROM A BREEDING HEN BUILDING IN PORTUGAL

PEREIRA, J.L.S.<sup>1</sup>, FERREIRA, S.<sup>2</sup>, CONDE, A.<sup>3</sup>, FERREIRA, P.<sup>3</sup>, PINHEIRO, V.<sup>2</sup>, TRINDADE, H.<sup>2</sup>

<sup>1</sup> Polytechnic Institute of Viseu, ESAV, Quinta da Alagoa, Viseu, Portugal; <sup>2</sup> University of Trás-os-Montes and Alto Douro, ECAV, Quinta de Prados, Vila Real, Portugal; <sup>3</sup> LUSIAVES, Marinha das Ondas, Figueira da Foz, Portugal

### INTRODUCTION

Poultry production is a significant source of ammonia (NH<sub>3</sub>), nitrous oxide (N<sub>2</sub>O), carbon dioxide (CO<sub>2</sub>) and methane (CH<sub>4</sub>) emissions and few published data are available for Mediterranean countries. The aim of this study was to assess the NH<sub>3</sub>, N<sub>2</sub>O, CO<sub>2</sub> and CH<sub>4</sub> emissions on commercial breeding hen's buildings under Portuguese climate conditions.

### MATERIAL AND METHODS

The study was made in the commercial breeding hen farm Quinta da Cruz located in central Portugal (Soure, Portugal). The building (length = 80 m, width = 16 m) was equipped with automatic feeding and drinking systems (Roxell), evaporative cooling pads (CELdek) and a climate control system (F37, Fancom). Ventilation was made by minimum transitional tunnel ridge system being controlled with one differential pressure (Fancom), and two sensors of temperature (SF7, Fancom) and two sensors of relative humidity (RHM.17 for inside and RHO.17 for outside, Fancom) located indoor and outdoor the building. Additional information about the production practices and management are given in Table 1 and in Pereira et al. (2017).

The NH<sub>3</sub>, N<sub>2</sub>O, CO<sub>2</sub> and CH<sub>4</sub> concentrations at indoor building were measured continuously in two occasions, first between 16 May and 14 June 2017 (hot season), and second from 23 November to 20 December 2017 (cold season). The concentrations of these four gases were measured with a photoacoustic field gas monitor (INNOVA 1412, Lumasense Technologies) and air samples collected, in sequence (2 minute intervals), through 6 sampling points (2 points located outdoor and 4 points located indoor), by a multipoint sampler (INNOVA 1409, Lumasense Technologies). Sampling points were made using Teflon tubes (3 mm internal diameter) equipped with PTFE-filters (1 µm pore size, Whatman) to protect from dust. The climate data were collected (1 minute intervals) from the environmental control system of the building. The average gas concentrations were defined as the average of the hourly mean concentrations measured. All data obtained from the monitored building were analysed by Excel spreadsheet using descriptive statistics and t-test was used for comparison of means by the software Statistix 7.0.

### RESULTS AND DISCUSSION

The climate data as well as the gas concentrations and emissions are shown in Table 1. To obtain fertile eggs for meat production, the breeding of hens begin when they are 20 weeks old and end when they are about 60 weeks old. As can be observed in Table 1, the NH<sub>3</sub>, N<sub>2</sub>O, CO<sub>2</sub> and CH<sub>4</sub> emissions were significantly higher in hot season relative to cold season, being related with age and weight of the hens, manure moisture, manure built-up litter and indoor air temperature and ventilation rate (Méda et al., 2011; Lin et al., 2017; Pereira, 2017). The annual average NH<sub>3</sub> (0.52 g day<sup>-1</sup> hen<sup>-1</sup>) and CH<sub>4</sub> (0.092 g day<sup>-1</sup> hen<sup>-1</sup>) emission rates obtained in the present study are comparable with values compiled by Méda et al. (2011) (0.26-0.92 g NH<sub>3</sub> day<sup>-1</sup> hen<sup>-1</sup> and 0.080 g CH<sub>4</sub> day<sup>-1</sup> hen<sup>-1</sup>). However, the average N<sub>2</sub>O emission rate reported in this study (0.030 g day<sup>-1</sup> hen<sup>-1</sup>) was higher than values reported in Méda et al. (2011) (0.0022-0.0026 g day<sup>-1</sup> hen<sup>-1</sup>). The differences between the studies previously referred on N<sub>2</sub>O emission rates might be related with temperature and diet, particularly the nitrate content of the diet. The annual average CO<sub>2</sub> emission rate of this study (169.6 g day<sup>-1</sup> hen<sup>-1</sup>) was higher than emission rate reported by Lin et al. (2017) in USA (89.9 g day<sup>-1</sup> hen<sup>-1</sup>).

Table 1. Average climatic conditions, gas concentrations and cumulative emissions (mean  $\pm$  standard deviation) in a commercial breeding hen building.

Parameters		Hot season	Cold season
Poultry husbandry	Breeder	Cobb	Cobb
	Average number	7053	7186
	Age (days)	326-355	150-174
	Liveweight (kg)	3.8-3.9	2.5-2.9
	Litter material (2 kg m <sup>-2</sup> )	New rice hulls	New rice hulls
Climatic conditions	Outdoor temperature (°C)	20.7 $\pm$ 1.9 <sup>a</sup>	8.0 $\pm$ 2.1 <sup>b</sup>
	Indoor temperature (°C)	23.2 $\pm$ 1.2 <sup>a</sup>	16.2 $\pm$ 1.1 <sup>b</sup>
	Outdoor relative humidity (%)	72.7 $\pm$ 8.2 <sup>a</sup>	83.3 $\pm$ 6.6 <sup>b</sup>
	Indoor relative humidity (%)	77.0 $\pm$ 6.7 <sup>a</sup>	91.0 $\pm$ 4.0 <sup>b</sup>
	Ventilation rate (m <sup>3</sup> h <sup>-1</sup> hen <sup>-1</sup> )	18.1 $\pm$ 3.9 <sup>a</sup>	2.5 $\pm$ 0.4 <sup>b</sup>
Gas measurements	Measurement campaign	16 May to 14 June 2017	23 Nov. to 20 Dec. 2017
	Sampling interval	Every 2 minutes	Every 2 minutes
	Sampling equipment	INNOVA 1409+1412	INNOVA 1409+1412
Gas concentrations	NH <sub>3</sub> (mg m <sup>-3</sup> )	3 $\pm$ 1 <sup>b</sup>	9 $\pm$ 6 <sup>a</sup>
	N <sub>2</sub> O (mg m <sup>-3</sup> )	1 $\pm$ 0 <sup>a</sup>	1 $\pm$ 0 <sup>a</sup>
	CO <sub>2</sub> (mg m <sup>-3</sup> )	1374 $\pm$ 94 <sup>b</sup>	2886 $\pm$ 802 <sup>a</sup>
	CH <sub>4</sub> (mg m <sup>-3</sup> )	0.4 $\pm$ 0.4 <sup>a</sup>	0 $\pm$ 0 <sup>a</sup>
Gas emissions	NH <sub>3</sub> (g day <sup>-1</sup> hen <sup>-1</sup> )	0.709 $\pm$ 0.167 <sup>a</sup>	0.321 $\pm$ 0.278 <sup>b</sup>
	NH <sub>3</sub> (g day <sup>-1</sup> LU <sup>-1</sup> )	54.557 $\pm$ 12.850 <sup>a</sup>	24.684 $\pm$ 21.421 <sup>b</sup>
	N <sub>2</sub> O (g day <sup>-1</sup> hen <sup>-1</sup> )	0.060 $\pm$ 0.013 <sup>a</sup>	0.001 $\pm$ 0.001 <sup>b</sup>
	N <sub>2</sub> O (g day <sup>-1</sup> LU <sup>-1</sup> )	4.586 $\pm$ 0.994 <sup>a</sup>	0.044 $\pm$ 0.094 <sup>b</sup>
	CO <sub>2</sub> (g day <sup>-1</sup> hen <sup>-1</sup> )	209.3 $\pm$ 22.0 <sup>a</sup>	129.8 $\pm$ 35.7 <sup>b</sup>
	CO <sub>2</sub> (g day <sup>-1</sup> LU <sup>-1</sup> )	16103.6 $\pm$ 1694.5 <sup>a</sup>	9985.3 $\pm$ 2746.5 <sup>b</sup>
	CH <sub>4</sub> (g day <sup>-1</sup> hen <sup>-1</sup> )	0.185 $\pm$ 0.182 <sup>a</sup>	0.000 $\pm$ 0.000 <sup>b</sup>
CH <sub>4</sub> (g day <sup>-1</sup> LU <sup>-1</sup> )	14.210 $\pm$ 14.021 <sup>a</sup>	0.000 $\pm$ 0.000 <sup>b</sup>	

Values presented with different superscripts within rows are significantly different ( $p < 0.05$ ).

One hen = 0.013 LU (livestock unit) (REAP, 2013).

## CONCLUSION

The annual average emission rates from commercial breeding hen's buildings under Portuguese climate conditions were 0.52 $\pm$ 0.27, 0.030 $\pm$ 0.042, 169.6 $\pm$ 56.2 and 0.092 $\pm$ 0.131 g day<sup>-1</sup> hen<sup>-1</sup> for NH<sub>3</sub>, N<sub>2</sub>O, CO<sub>2</sub> and CH<sub>4</sub>, respectively.

**Acknowledgements:** This study was funded by project POCI-01-0247-FEDER-003430 AMONIAVE.

## REFERENCES

- Lin, X., Zhang, R., Jiang, S., El-Mashad, H., Xin, H., 2017. Emissions of ammonia, carbon dioxide and particulate matter from cage-free layer houses in California. *Atmospheric Environment* 152, 246-255.
- Méda, B., Hassouna, M., Aubert, C., Robin, P., Dourmad, J.Y., 2011. Influence of rearing conditions and manure management practices on ammonia and greenhouse gas emissions from poultry houses. *World's Poultry Science Journal* 67, 441-456.
- Pereira, J.L.S., 2017. Assessment of ammonia and greenhouse gas emissions from broiler houses in Portugal. *Atmospheric Pollution Research* 8, 949-955.
- Pereira, J.L.S., Ferreira, S., Garcia, C.S.P., Conde, A., Ferreira, P., Pinheiro, V., Trindade, H., 2017. Assessment of ammonia and carbon dioxide concentrations in a breeding hen building under Portuguese winter. *International Journal of Food and Biosystems Engineering* 5, 1-6.
- REAP, 2013. Decree number 81/2013 of 14 June regarding animal manure management (REAP). In: *Diário da República, Série I*, number 113 of 14 June 2013. Portugal, pp. 3304-3329.

## RESIDUAL EFFECT AND NITROGEN USE EFFICIENCY OF N FERTILIZERS IN A MAIZE/WHEAT ROTATION

VALENTIN, F.<sup>1</sup>, CALVO, M.<sup>2</sup>, GABRIEL, J.L.<sup>3</sup>, ALONSO-AYUSO, M.<sup>4</sup>, QUEMADA, M.<sup>4</sup>

<sup>1</sup> FUNDESCAM, Spain; <sup>2</sup> ITAGRA, Spain, <sup>3</sup> INIA, Spain, <sup>4</sup> Universidad Politécnica de Madrid, Spain

### INTRODUCTION

Nitrogen fertilizers may have a residual effect in the subsequent crops that might affect N use efficiency (NUE) in the cropping system, and the use of nitrification inhibitors might enhance this residual effect [1]. The objective of this work was to study the residual effect of synthetic N fertilizers and determine how it affects NUE in a maize/wheat crop rotation. To achieve this goal we studied a traditional fertilizer and a fertilizer with a nitrification inhibitor (DMPP) under field conditions in three different locations. As a complementary objective we try to elucidate the reasons behind the residual effect by conducting laboratory experiments to determine non-readily exchangeable ammonium and N in the soil microbial biomass.

### MATERIAL AND METHODS

Field experiments were conducted from April 2016 to July 2017 at three different locations in Spain: Barrax (Albacete), Aranjuez (Madrid), Villoldo (Palencia). The crop rotation was maize/wheat and the experimental design consisted on three treatments for maize (control, fertilization with ammonium sulphate nitrate (ASN), and fertilization ASN blended with the nitrification inhibitor DMPP (3,4dimethylpyrazole phosphate (ENTE<sup>®</sup>)), that were split in to three wheat treatments (control, ASN at recommended rate, ASN at reduced rate). Each treatment had four replications randomly distributed. The climate was Mediterranean (temperate, semi-arid and cold for each location) and the crops were irrigated. The soils had different textures (Silt loam, Clay loam, Sandy clay loam) and pH (7.9, 8.0, 6.5).

The grain yield and N grain content were assessed at harvest. The soil inorganic N content was determined in the top 40 cm of soil before sowing maize and wheat. Two components of the N use efficiency were calculated: the agronomic efficiency (ANE) that refers to the kg of grain yield increase obtained per kg of N applied, and the N use efficiency that is the ratio between the N inputs and N outputs.

Between maize harvest and wheat sowing, soil samples were taken to determine the N mineralization potential by aerobic incubation, the C and N content of microbial biomass by fumigation, and the non-exchangeable NH<sub>4</sub><sup>+</sup> by the potassium hypobromite dry soil combustion method.

### RESULTS AND DISCUSSION

Maize yield, grain N content and crop N uptake were lower for the control than for the fertilized treatments in the three locations, and no differences in these variables were found between ASN and ENTE<sup>®</sup> treatments. The maximum yield of the experiments ranged from 18.4 in Barrax to 8.3 Mg ha<sup>-1</sup> in Villoldo, showing the difference productivity of the locations. After maize harvest, there were not significant differences in soil inorganic N content in the upper 40 cm layer between treatments in any of the locations, and Aranjuez and Villoldo had higher soil inorganic N content (≈60 kg N ha<sup>-1</sup>) than Barrax (≈15 kg N ha<sup>-1</sup>).

In Aranjuez and Villoldo grain yield in control plots (non fertilized wheat) was higher in the treatments of previous fertilized maize (ASN and ENTE<sup>®</sup>) than in the control (Fig.1A). In Barrax, ASN plots achieved a greater wheat yield than the control, being ENTE<sup>®</sup> in between. In addition, the grain N content in control plots in Aranjuez and Villoldo was higher in the treatments of previous fertilized maize (ASN and ENTE<sup>®</sup>) than in the control (Fig. 1B). In Barrax, no differences between treatments were observed. These results show a residual effect of both

fertilizers, ASN and ENTEC®, in Aranjuez and Villoldo but not a clear residual effect in Barrax. Even more, in Aranjuez the residual effect of ENTEC® was larger than in ASN as was already reported [1].

The impact on wheat ANE was observed in Aranjuez and Villoldo. In Aranjuez, ANE values in control plots were higher than in ENTEC®-low rate treatment. In Villoldo, ANE in control-low rate treatment was more efficient than in ASN-recommended rate, showing ASN residual effect. In Aranjuez,  $NUE > 1$  was observed for the wheat plots following the ASN and ENTEC® treatments, suggesting that maize residual N was uptake by the wheat.

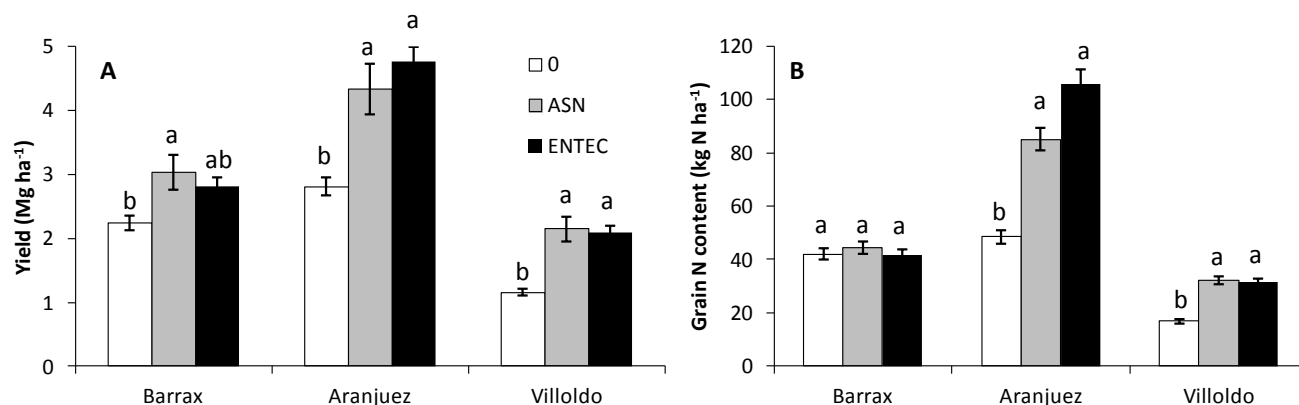

Figure 1. Wheat yield (A) and grain N content (B) in control plots of 2017, that received either 0, ASN or ENTEC® in 2016. Different letters meaning significant differences in each location (Duncan 95%).

In the two locations that had a clear N residual effect related to the fertilized treatments there was a tendency to increase C and N retained in the microbial biomass after application of ASN or ENTEC®, suggesting that fertilized treatments enhanced C and N retention in the organic pool. Soils with high smectites content and low available potassium had a high capacity for  $NH_4^+$  clay fixation. Nevertheless, the layers with a higher fixation capacity appeared only in Aranjuez and below 0.4 m in the soil profile; therefore,  $NH_4^+$  fixation in clay layers do not seem to be responsible for the residual effect observed.

## CONCLUSIONS

In a maize/wheat crop rotation, the residual N effect of fertilizers was clearly observed in two locations (Aranjuez and Villoldo) and suggested in the third (Barrax). The residual effect occurred as a result of N fertilizer application in the previous, either ASN or ENTEC®. The soil inorganic N presented in the fertilized plots before planting wheat was high and masked the residual N effect or possible differences between fertilized treatments.

In the two locations that had a clear N residual effect related to the fertilized treatments there was a tendency to increase C and N retained in the microbial biomass, suggesting that fertilized treatments enhanced C and N retention in the organic pool.

**Acknowledgements:** EuroChem Agro, Spanish Ministry (AGL201452310R), Comunidad Madrid (S2013/ABI2717). The funders had no role in the data collection and analysis or preparation of the manuscript.

## REFERENCES

Alonso-Ayuso M., Gabriel J.L., Quemada M., 2016. Nitrogen use efficiency and residual effect of fertilizers with nitrification inhibitors. *Eur. J. Agron.* 80: 1-8.

## LONG – TERM CONSEQUENCES OF UNBALANCED FERTILIZATION WITH NITROGEN AND PHOSPHORUS

RUTKOWSKA, A.

Institute of Soil Science and Plant Cultivation – State Research Institute in Puławy, Poland

### INTRODUCTION

Natural farming conditions in Poland are poor, due to prevalence of light sand-derived soils and, unfavourable climate. Soil acidity and related low content of available forms of macronutrients are the most limiting factors for crop production. However, nitrogen (N) remains most limiting factor, and application dose are currently increasing. The average fertilizer application dose is  $140 \text{ kg} \cdot \text{ha}^{-1}$  with a N Phosphorus (P) K (Potassium) ratio of 1: 0,3: 0,3. Considering that over 30% of Polish soils have low to very low content of available phosphorus, this practice may result in a considerable soil mining of soil P, and then, disturbance in physiological processes in plants. Long term depletion of the available P pool through crop uptake may modify the P pools in soils, by a most important fixation of soluble P after P fertilization. Thus, most of soluble P applied to the soil will not be practically utilized by crops in the first vegetation period (Sharpley, 1995, Jianbo et al., 2011). The aim of the investigation was to evaluate the long-term consequences of soil phosphorus mining while nitrogen fertilisation rates are increasing.

### MATERIAL AND METHODS

Field experiments were carried out at two experimental stations of the Institute of Soil Science and Plant Cultivation in 2003-2014, at Grabów and at Baborówko. Four crops were grown each year in the rotation of winter oilseed rape - winter wheat – maize - spring barley. The first factor was P fertilization in two level doses (+ and -), and the second one were six levels of N doses. The initial content of available phosphorus in Grabów was 16 and in Baborówko  $32 \text{ mg P}_2\text{O}_5 \cdot 100 \text{ g}^{-1}$  soil. Total N rates in the experiments over 12 years were: 0, 510, 1020, 1530, 2040, 2550  $\text{kg N} \cdot \text{ha}^{-1}$ , and phosphorus rates: 405  $\text{kg P} \cdot \text{ha}^{-1}$  in P plus and 0  $\text{kg P} \cdot \text{ha}^{-1}$  in P minus treatment. After harvest of barley, soil was sampled from the ploughed layer and analyzed for  $\text{P}_2\text{O}_5$  content by Egner-Riehm DL method. The samples of grain and straw were collected at full maturity each year and analysed for the content of N and P. Statistical processing of the results was performed using the Statgraphics 5 Plus package (Statgraphics Plus, Rockville, USA). The Tukey's test has been applied to evaluate the significance of differences between the treatments. In the paper, consequences of twelve – years soil phosphorus mining are presented. Yields of crops were considered as the productive effect of unsustainable N and P fertilization, and the concentration of available P forms in soil as well as balances of N and P as the environmental effects.

### RESULTS AND DISCUSSION

In the both experimental sites, twelve years without phosphorus fertilization caused only slight crop reduction of all the crops, and the differences between P plus and P minus treatments were not statistically significant. Yields were variable in the years and strongly determined by weather conditions. The average yields were as follows: oilseed rape 2,99 in P plus treatment, and 2,91 in P minus, wheat – 4,95 and 4,71, maize 7,08 and 6,90, barley – 3,80 and 3,64  $\text{t} \cdot \text{ha}^{-1}$  in Grabów. In Baborówko, oilseed rape yielded on the level 2,17 in P plus treatment and 2,13 in P minus treatment, wheat – 4,21 and 4,18, maize 6,91 and 6,85, barley – 3,09 and 3,03  $\text{t} \cdot \text{ha}^{-1}$ . Fertilization with phosphorus increased the content of this element, mainly in straw, hence, the total uptake of P by crops. Phosphorus balance was influenced both by P and N fertilization. In the treatment P plus, the surplus of phosphorus was obtained in the whole range of nitrogen rates. In P minus treatment, the balance was the more negative, the higher nitrogen dose. In the both sites, nitrogen rates N4-N5 exclusively ensured the surplus of nitrogen through the whole 12-years period of the experiment (*table 1*).

Table 1. Nitrogen and phosphorus balances for 12 years of the experiment in Grabów and Baborówko

N rate kg · ha <sup>-1</sup>	Grabów				Baborówko			
	N balance		P balance		N balance		P balance	
	P Plus	P Minus	P Plus	P Minus	P Plus	P Minus	P Plus	P Minus
N0 0	-853	-830	196	-163	-530	-545	266	-103
N1 510	-590	-587	167	-194	-330	-353	220	-153
N2 1020	-496	-440	133	-225	-288	-219	151	-197
N3 1530	-276	-148	119	-234	-55	-32	123	-230
N4 2040	48	118	116	-239	288	310	104	-252
N5 2550	401	468	105	-247	620	654	87	-273
Average	-294	-236	139	-217	-49	-20	159	-201

Soil depletion from phosphorus caused the significant changes of its available forms through the 12 years. In the both sites, the decrease of available P<sub>2</sub>O<sub>5</sub> was observed between the three rotations of the experiments. In Grabów, the content of P available dropped to 13,2, and in Baborówko to 27,2 mg P·100 g<sup>-1</sup> soil, but under the highest nitrogen rate to 11 and 23,2 mg P· 100 g<sup>-1</sup> soil, respectively (*Figure.1*)

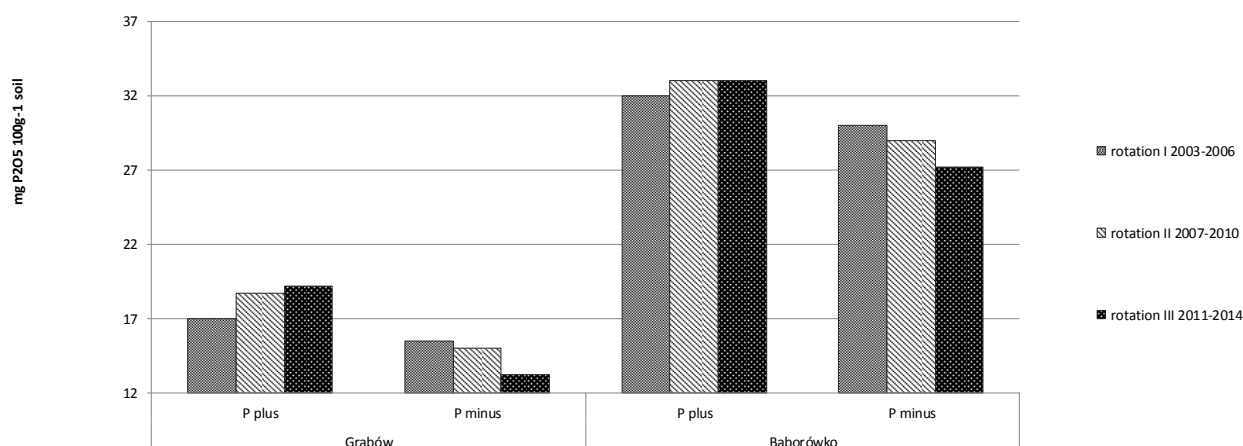

Figure 1. The average content of P<sub>2</sub>O<sub>5</sub> in the plough layer of soil in experimental sites in the following crop rotations

Nevertheless, the average final concentration of P<sub>2</sub>O<sub>5</sub> in Grabów was classified as the medium content in Polish soils (recommended), and in Baborówko as the high content (for the environmental reason careful P fertilization recommended). According to fertilizer recommendation in Poland, the nutrient within medium and high soil fertility categories is considered as an adequate and probably not limiting crop growth.

## CONCLUSION

Twelve years without phosphorus applications to soil with medium and high P content did not affect significantly grain yields but strongly reduced concentration of P available in the plough layer. The negative balance of phosphorus in both experimental sites was enhanced by increasing nitrogen fertilization rates.

**REFERENCES**

Jianbo S., Lixing Y., Junling Z., Hainang L., Zhaohai B., Xinping Ch., Weifeng Z., Fusou Z., 2011. Phosphorus dynamics: from soil to plant. *Plant Physiol.*, 156, 997-1005.

Sharpley A., N., 1995. Soil phosphorus dynamics: agronomic and environment impact. *Ecol. Engin.* ,5, 261-279.

## NITROGEN BALANCE AND CROP NITROGEN UPTAKE IN LONG-TERM LYSIMETRIC INVESTIGATION

MIROSLAV F., SMATANOVÁ M., HYNŠT J., NĚMEC P.

Central Institute of Supervising and Testing in Agriculture, Hroznová 2, 656 06 Brno, Czech Republic

### INTRODUCTION

Many studies report the effect of different rates of N addition on crop yield and leaching of excessive mineral N. However, the effect of annual variation of N inputs and N balance in crop sequence is seldom studied. At steady rate of N fertilization, annual rates usually varies according to supposed crop demands. When annual input is applied, it does not always correspond with plant N uptake. Consequently, low N should decrease plant N uptake, mineral N accumulation in soil and losses of added N, while excessive N should increase mineral N accumulation in soil and losses of added N. Information about the short-term or long-term effect of varying annual N balance in crop sequence is limited. Short-term and long-term effects of N addition on N balance, N pools and N fluxes were studied in 20-year field investigation using lysimeters at 7 locations. Pools and fluxes of mineral N were selected as easily measurable and sensitive indicator of changes of N transformations in soil. We hypothesized that the amount of N added to soil or N lost from soil induces equivalent change of plant uptake, soil mineral N accumulation and N losses.

We also hypothesized that long-term deficit decreases and surplus increases soil  $N_{\min}$ , yield and losses with time.

### MATERIAL AND METHODS

Lysimetric measurements were performed at 12 locations of Central Institute of Supervising and testing in Agriculture in the Czech Republic. They were established in 1985 and to this date, 30 years of measurements were performed. For the purpose of current study, results of 20 years (1996 – 2016) of measurements at 7 locations were evaluated. At each location, lysimeters were set up at field sites with crop sequence containing cereals, legumes and row crops. Annual rate of fertilization was adjusted according to supposed demands of crops.

In each lysimeter, collectors were inserted into the wall of working hole. The structure of soil above the collector was not disturbed. Rainfall water percolates through soil profile into collector and it is drained into plastic bottle where it accumulates. Bottles are situated in the pit that is separated by wooden board from the rest of the working hole. Working hole outside of the pit was filled with soil after finishing of lysimeter construction. The amount of water in bottles was regularly determined and samples of water were collected from three depths (0-30, 30-60, 60-80 cm). Soil samples from soil layers 0 – 30 and 30 – 60 for mineral N measurements were collected in two terms during the year - in spring and after harvest. Yield of harvested products was determined and content of N was determined in plant material. Soil mineral N ( $N_{\min}$ ) in 0 – 60 cm soil layer in spring and after harvest, leaching below 80 cm and plant N uptake were evaluated. Soil mineral N content was calculated as sum of  $NH_4^+$  and  $NO_3^-$  content in soil. Plant N uptake was calculated from yield and N content of harvested products.

Soil mineral nitrogen was quantified colorimetrically according to Zbiral et al., (2011).

Biomass of plants was air dried and ground and dry matter yield was estimated. Nitrogen in plant biomass was estimated as Kjeldahl nitrogen (Zbiral et al., 2014).

Statistical analyses were performed using Statistica 12 software. Correlations between measured parameters were calculated using Pearson's correlation coefficient.



## RESULTS AND DISCUSSION

At the outset we expected that increasing rate of annual N inputs or N balance increases  $N_{\min}$  in soil, crop N uptake and leaching. We also supposed that long-term deficit decreases and surplus increases soil  $N_{\min}$ , N uptake and losses with time. These assumptions were only partially supported by obtained data. Increasing rate of fertilization increased crop N uptake. At the same time, effect of N inputs on  $N_{\min}$  in soil and N leaching was not observed. Mean N balance was negative at most of studied locations. Effect of N balance on N uptake and  $N_{\min}$  in soil was insignificant and long-term changes of measured parameters were limited. Results therefore confirmed hypothesis, that increasing N input increased crop N uptake. However, effect of N input on  $\text{NO}_3^-$  leaching and soil  $N_{\min}$  concentration was insignificant. Negative annual N balance was observed at most locations, but it was without effect on  $N_{\min}$  and leaching of  $\text{NO}_3^-$ . Despite negative N balance soil sustains crop productivity and N availability at almost constant level and long-term changes were limited. Decline or accumulation of soil N were low and soil has still capacity to store and release nutrients for crop growth despite varying rate of N inputs and N losses. Level of soil  $N_{\min}$ , losses and yield are maintained from soil reserves for relatively long time without significant changes. Possible sources of missing N may be undetected atmospheric inputs (Karimi et al., 2017), underestimated  $\text{N}_2$  fixation or uptake of soil N from deeper soil layers. Stability of mineral N pools and fluxes may be also partially attributed to organic fertilization and planting of legumes at studied locations. Legumes not only provide additional N, but they also access deep leached  $\text{NO}_3^-$  below 80 cm. It also confirms sustainability of cropping systems used in the experiment.

## CONCLUSION

Increasing rate of N input increased crop N uptake, but the rate of input and annual N balance had marginal effect on  $\text{NO}_3^-$  leaching and soil  $N_{\min}$  concentration. Despite negative N balance soil sustains crop productivity and N availability at almost constant level and long-term changes were limited. Results suggest that not estimated sources of N helps to keep sustainability of studied cropping systems.

## REFERENCES

- Karimi, R., Janzen, H. H., Smith, B. H., Ellert, B. H., Kröbel, R., 2017. Nitrogen balance in century-old wheat experiment. *Canadian Journal of Soil Science*, in press.
- Zbiral, J., Čižárová, E., Dočkalová, R., Fojtlová, E., Hájková, H., Holcová, H., Kabátová, N., Niedobová, E., Rychlý, M., Staňková, K., Urbánková, E., Vilamová, V., Žalmanová, A., 2014. Plant analysis. Czech Central Institute for Supervising and Testing in Agriculture, Brno, 120 pp. (in Czech).
- Zbiral, J., Malý, S., Váňa, M., Čuhel, J., Fojtlová, E., Čižmár, D., Žalmanová, A., Srnková, J., Obdržálková, E., 2011. Soil analyses, Part III. Czech Central Institute for Supervising and Testing in Agriculture, Brno, 253 pp. (in Czech)

## THE EFFECT OF NITROGEN APPLICATION METHODS ON MAIZE (*ZEA MAYS L.*) YIELD

SZÉLES, A.<sup>1</sup>, HORVÁTH, É.<sup>1</sup>, KITH, K.<sup>1</sup>, RAGÁN, P.<sup>1</sup>

<sup>1</sup>University of Debrecen, Faculty of Agricultural and Food Sciences and Environmental Management, Institute for Land Utilisation, Regional Development and Technology, Hungary

### INTRODUCTION

The Member States of the European Union produced 62,677 thousand tons of maize in 2016. Within the EU, Hungary belongs to the most significant maize producers with its 8,730 tons of production, ranked as the 3rd highest amount (FAO, 2017). However, average yield is highly variable. Extremities caused by climate change pose a serious problem. For this reason, technological developments are needed to achieve yield increase despite the constantly changing weather conditions.

Maize yield is greatly affected by N fertilisation (Nagy, 2008; Ványiné et al., 2012). The accurate determination of nitrogen quantity and its application are of key significance from the aspect of yield, quality and the environment (Edmonds et al., 2013). The aim of this research is to examine the effect of nitrogen fertilisation management on yield.

### MATERIAL AND METHODS

Measurements were conducted at the Experiment Site of the University of Debrecen, Hungary, in an experiment established on mid-heavy calcareous chernozem soil with deep humus layers in 2011, 2012 and 2013. The experiment had a split-split-plot design and two replications. The main plots represented the different irrigation treatment (irrigated and non-irrigated), while the split plots represent fertiliser doses and hybrids. This study focuses on the examination of the non-irrigated plots of the FAO 410 hybrid.

During the growing season the mean temperature of the research area was 18.2, 18.8 and 22.8°C in 2011, 2012 and 2013, respectively. The amount of precipitation was 324, 276 and 252 mm in the three consecutive years, respectively. Based on the temperature and precipitation in the examined period and comparing them to the multiple-year average, 2011 was around the average, while the temperature in 2012 was 1.5 °C warmer and the amount of rainfall was 64 mm lower. 2013 was the driest (-88 mm) and warmest (+5.5°C) of the examined years.

In the experiment, 60 and 120 kg N ha<sup>-1</sup> basic fertiliser dose was applied in addition to the non-fertilised control treatment (technology 1). This dose was applied as ammonium nitrate in all three treatments in the spring, one month before sowing. In addition to the second and third fertiliser level of all treatments (except for control plots), 30 kg N ha<sup>-1</sup> was applied at the V6 growth stage (technology 2) and further 30 kg N ha<sup>-1</sup> was applied at the V12 phenophase (technology 3) in the third treatment. The final fertiliser level was 0, 90 and 150 kg N ha<sup>-1</sup> in the second treatment and 0, 120 and 180 kg N ha<sup>-1</sup> in the third treatment.

GLM was used to demonstrate the effect of treatments on yield. To compare the mean values of the applied treatments, LSD<sub>5%</sub> was determined. During multiple comparison, confidence intervals were corrected using Duncan's test to avoid the accumulation of alpha error. Evaluation was performed using SPSS for Windows 21.0.

### RESULTS AND DISCUSSION

Based on the statistical evaluation, there was no significant difference between yields as a result of N fertiliser treatments before sowing (A\_60 and A\_120) in 2011. The highest yield (14.171 t ha<sup>-1</sup>) resulted from applying 120 kg N ha<sup>-1</sup> basic fertilisation plus 30 kg N ha<sup>-1</sup> at the V6 phenophase (V6\_150). The V12\_180 treatment caused a significant (P<0.05) yield decrease of 1529 kg ha<sup>-1</sup> compared to the V6\_150 treatment. The average yield of non-

fertilised plots was 12.239 t ha<sup>-1</sup> in 2012. On the contrary, the A\_60 basic fertilisation resulted in a surplus of 1730 kg ha<sup>-1</sup>, which was exceeded by that of treatments A\_120 and V6\_90, but this increase is not statistically significant. The most effective treatment was shown to be V6\_150 (15.849 t ha<sup>-1</sup>) (P<0.05). In 2013, the yield of the non-fertilised treatment was significantly (P<0.05) lower by 2325 kg ha<sup>-1</sup> than the yield of the lowest N dose applied as basic fertilisation (A\_60). As a result of further increasing the N dose by 60 kg ha<sup>-1</sup> as basic fertilisation, the obtained yield significantly increased by 1721 kg ha<sup>-1</sup>. The 30 kg N ha<sup>-1</sup> added to the A\_60 N ha<sup>-1</sup> basic fertilisation at the V6 phenophase (V6\_90) had a similar result to the yield of the A\_60 treatment and the difference between the A\_120 and V6\_150 treatments did not cause any significant difference either. The highest yield was provided by the V6\_150 treatment (13.090 t ha<sup>-1</sup>), which showed a difference from the basic fertilisation and the V6\_90 treatment at a significance level of 5%. However, the extra 30 kg N ha<sup>-1</sup> applied at the V12 phase was not successful.

The yearly technological evaluation showed that in 2011, technology 2 resulted in the highest yield (13.722 t ha<sup>-1</sup>). This technology increased the yield of technology 3 by 8% (P<0.05), and it did not show significant difference from technology 1 (13.352 t ha<sup>-1</sup>). There was no significant difference between each technology in 2012 and 2013.

The crop year effect evaluation showed that the use of technology 1 and 2 resulted in similar yields in 2011 and 2012, the environmental factors did not have any effect. However, this effect was significant (P<0.05) in 2013, resulting in a 20% decrease in comparison with 2012 and 11.5% compared to 2011. Technology 3 was the most successful in 2012, resulting in a 16.3% yield surplus compared to 2011 and 19.4% extra yield in comparison with 2013.

## CONCLUSION

From the aspect of the development of maize, the distribution of rainfall during the growing season was a more significant factor than the quantity of precipitation. This finding is also demonstrated by the fact that, of the three examined years, the main average yield was the highest (13.947 t ha<sup>-1</sup>) in 2012, when the 276 mm rainfall during the growing season had a favourable distribution, thereby improving nutrient availability. In all three years, spring basic fertilisation improved maize development even on chernozem soil, which is properly supplied with nutrients. Although the effect of top-dressing was not shown in yield increase, it reduced the stress caused by environmental factors. The success of maize production can be favourably affected with nutrient supply adapted to the various phenophases of the crop.

**Acknowledgements:** The research was financed by the Higher Education Institutional Excellence Programme of the Ministry of Human Capacities in Hungary, within the framework of the 4.thematic programme of the University of Debrecen, and the projects “GINOP-2.2.1-15-2016-00001 - Developing a scale-independent complex precision consultancy system” and “EFOP-3.6.3-VEKOP-16-2017-00008”.

## REFERENCES

- Edmonds D.E., Tubaña B.S., Kelly J.P., Crain J.L., Edmonds M.D., Solie J.B., Taylor R.K., Raun W.R., 2013. Maize grain yield response to variable row nitrogen fertilization. *J. Plant Nutr.*, 36.7: 1013-24.
- FAO, 2017. <http://www.fao.org/faostat/en/#data>
- Nagy J., 2008. Maize production: Food, bioenergy, forage. Akadémiai Kiadó, Budapest.
- Ványiné Széles A., Megyes A., Nagy J., 2012. Irrigation and nitrogen effects on the leaf chlorophyll content and grain yield of maize in different crop years. *Agr. Water Manage.*, 107: 133–144

## AGENT BASED MODELLING OF SHEEP MOVEMENT AND URINE DEPOSITION TO SUPPORT N<sub>2</sub>O EMISSION ESTIMATES IN UPLAND PASTURES

JOHNSON, S.C.M.<sup>1</sup>, WHELAN, M.J.<sup>1</sup>, BALZTER, H.<sup>1</sup>, LUSH, L.<sup>2</sup>, KING, A.J.<sup>2</sup>, TUCNY, E.<sup>2</sup>, WILSON, R.P.<sup>2</sup>, PERROTO-BALDIVIESO, H.L.<sup>3</sup>, CARDENAS, L.<sup>4</sup>, CHARTERIS, A.F.<sup>4</sup>, MARSDEN, K.A.<sup>5</sup>, HARRIS, I.<sup>5</sup>, HOLMBERG, J.<sup>5</sup> CHADWICK D.<sup>5</sup>

<sup>1</sup> University of Leicester, UK; <sup>2</sup> Swansea University, UK; <sup>3</sup> Texas A&M University, USA, <sup>4</sup> Rothamsted Research, UK, <sup>5</sup> Bangor University, UK

### INTRODUCTION

Livestock such as sheep make important contributions to N<sub>2</sub>O emissions via deposition of nutrients in urine [van Groenigen et al., 2005]. However, to date, most estimates of N<sub>2</sub>O emissions from grazed pastures have been derived from lowland soils. Relatively little is known about the response of N<sub>2</sub>O fluxes to sheep urine deposition in the uplands. N<sub>2</sub>O emissions depend on NO<sub>3</sub> availability, redox conditions (principally driven by moisture content), temperature, microbial community composition (e.g. the presence and activity of nitrifiers and denitrifiers), and the availability of reduced carbon substrates. To understand the response of emissions to these factors and the influence of urine deposition, it is important to examine the spatial and temporal pattern of sheep movement, occupancy and urine deposition across heterogeneous landscapes. These patterns are expected to show diurnal patterns and be influenced by, for example, topography, vegetation, conspecific behaviour, and individuals' energy state. Here, we present an agent-based model of sheep movement and compare our model output to high resolution behavioural and position data (GPS and inertial sensors) collected from a flock of sheep in an upland pasture in North Wales. We expect extensions of this model to support the quantification of the spatial and temporal distribution of urine-associated N<sub>2</sub>O fluxes across upland landscape.

### MATERIAL AND METHODS

Agent based modelling is a form of complex systems modelling, based on individual autonomous “agents”, each with its own properties and actions. Such models have the advantage that they are conceptually simple to understand but can be used to represent the complex interactions between multiple agents in the system. A common output is the prediction of emergent whole-system behaviour, where novel and coherent structures or patterns arise from interactions between the agents. For this project, the NetLogo modelling platform was selected (Wilensky et al., 2015) to model the movement of individual sheep across a landscape. Slope data were derived from freely available airborne LiDAR datasets and a spatial layer of normalised difference vegetation index (NDVI) was derived from the RapidEye satellite system which was used as a proxy for vegetation characteristics. Sheep movement and behaviour was informed by (1) information from the literature, and (2) data collected from a flock of n=30 Welsh Mountain ewes (*Ovis aries*) over 2x30 day periods whilst grazing a semi-improved upland pasture at Henfaes Agricultural Research Station, North Wales. Sheep positional data were gathered using collar-mounted GPS (Fehlmann et al. 2017) and behavioural data derived from rear-mounted acceleration sensors (Wilson et al., 2008).

In addition to generating the statistics of occupancy and urination for a single test site, the model can be applied to predict sheep movement and associated total N<sub>2</sub>O emissions (calibrated using experimental data on upland soil responses to sheep urine addition being collected in this project) in a wider landscape with similar characteristics.

### RESULTS AND DISCUSSION

Initial comparisons of our agent-based model and empirical data show high agreement. Sheep space use was highly variable across the landscape, showing occupancy “hot spots” resulting from sheep preferences for certain vegetation and topography linked to resting and grazing. Sheep space use also altered with season, in line with changes in the type and availability of vegetation. A comparison of sheep space use as predicted from the agent-based model and our observed empirical dataset is provided in Figure 1.

Urination events in our empirical dataset were not simply determined by patterns of space use (above), but instead showed distinct hot spots where urination occurred more frequently.

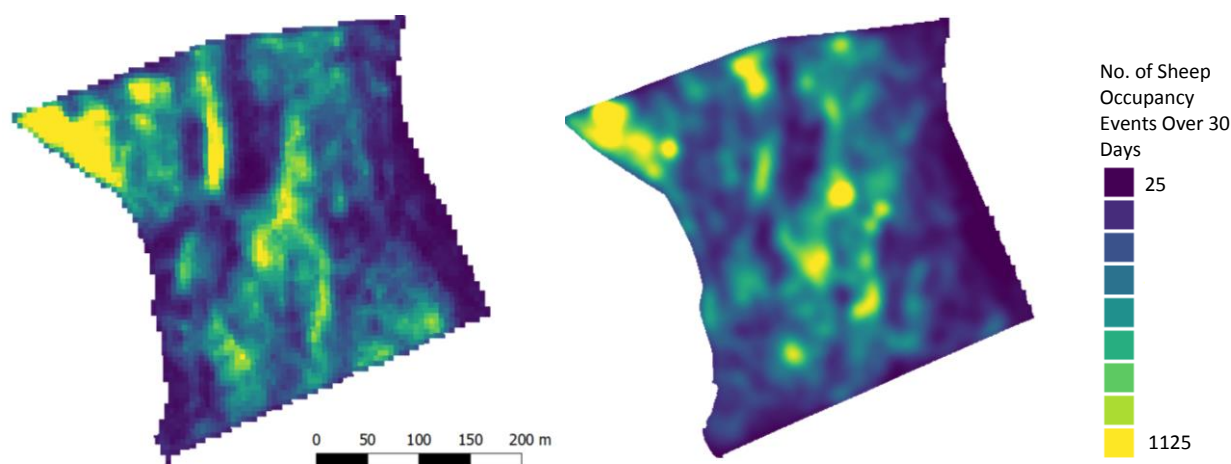

Figure 1. Modelled spatial locations of sheep (left) vs GPS derived locations of sheep (right).

## CONCLUSION

Given the agreement between our model and empirical data, this work presents a critical first step towards being able to accurately model the movement and urine deposition of sheep in upland environments. Application of the model over a larger upland area and implications for estimating whole landscape N<sub>2</sub>O emission enhancement as a result of urine deposition will be presented.

**Acknowledgements:** This work was funded by the UK Natural Environment Research Council (grant NE/M013154/1). RapidEye data were supplied by Planet Team (2017). Planet Application Program Interface: In Space for Life on Earth. San Francisco, CA. LiDAR data was supplied by Natural Resources Wales.

## REFERENCES

- Fehlmann, G., O’Riain, M. J., Hopkins, P. W., O’Sullivan, J., Holton, M. D., Shepard, E. L. C. King, A. J., 2017 Identification of behaviours from accelerometer data in a wild social primate. [Animal Biotelemetry](#) 5:6.
- van Groenigen, J.W., Kuikman, P.J., De Groot, W.J.M., Velthof, G.L. 2005. Nitrous oxide emission from urine-treated soil as influenced by urine composition and soil physical conditions. *Soil Biol. & Biochem.* 37 463-473.
- Wilensky, U., Rand, W. 2015. An introduction to agent-based modeling: Modeling natural, social and engineered complex systems with NetLogo. Cambridge, MA: MIT Press.
- Wilson, R.P., Shepard, E.L.C., Liebsch, N. 2008. Prying into the intimate details of animal lives: Use of a daily diary on animals. *Endangered Species Research* 4, 123-137.

## COMPARISON BETWEEN DIFFERENT STABILIZED NITROGEN FERTILIZERS IN MAIZE CROP

MATEO-MARÍN, N., QUÍLEZ, D., GUILLÉN, M., ISLA, R.

Agrifood Research and Technology Centre of Aragón (CITA), Aragon Government. Av. Montañana 930, 50059 Zaragoza, Spain

### INTRODUCTION

The use of fertilizers with nitrification and urease inhibitors aims to increase the lifetime of ammonium and urea in the soil, respectively, to improve the synchronization between crop demand and available soil nitrogen (Ladha *et al.*, 2005). One potential advantage is the reduction of the number of fertilizer applications and to enhance nitrogen use efficiency (NUE) by decreasing nitrate leaching and gas emissions. The objective of this study is to assess, in two contrasting soil types, if a single side-dress application of inhibited N fertilizer can replace the standard double side-dressing N fertilizer application of maize under semiarid irrigated conditions.

### MATERIAL AND METHODS

This study was conducted during two years (2015 and 2016) in an experimental field in the middle Ebro River Basin (Zaragoza, Spain) characterized by a semiarid Mediterranean climate (annual mean air temperature and mean precipitation of 14.5 °C and 308 mm, respectively). The study compared 4 fertilizer treatments in two soil types (deep vs. shallow) with contrasting soil water holding capacity. The N fertilizer treatments were: i) standard urea split into two applications at V6 and V13 ('Urea'); ii) a single application (V6) of urea with 3,4-dimethyl pyrazole phosphate (nitrification inhibitor) ('DMPP'); iii) a single application (V6) of urea with monocarbamide dihydrogen sulphate (urease inhibitor) ('MCDHS'); and iv) a single application (V6) of urea with N-(n-butyl) thiophosphoric triamide (urease inhibitor) ('NBPT'). The experiment was a completely randomized block design with three replicates for each soil type. All plots (5 m<sup>2</sup> each one) received a pre-planting application of 50 kg N ha<sup>-1</sup>, 100 kg P<sub>2</sub>O<sub>5</sub> ha<sup>-1</sup> and 150 kg K<sub>2</sub>O ha<sup>-1</sup>. The total N applied was calculated at each soil type to provide 250 kg N/ha (N fertilizer + soil nitrate at pre-planting). The total N applied each year is presented in Table 1. Maize (hybrid 'Pioneer P1758') was sprinkler irrigated and irrigation requirements were calculated using FAO methodology. The nutritional status of maize was evaluated with periodic measurements of leaf greenness (SPAD-502®, Minolta) at different vegetative and reproductive stages. Grain yield (GY), total aerial biomass (TAB) and total N uptake were measured, and the nitrogen use efficiency (NUE) was calculated as the total N uptake divided the N applied with fertilizer. Data were subjected to ANOVA and differences in treatment's means were assessed with the Tukey test (5% level of significance), using the SAS software.

### RESULTS AND DISCUSSION

Chlorophyll meter readings did not display significant differences between treatments in 2015 for the two soil types (data not shown). However, differences did show in 2016 (Fig. 1); in shallow soil, SPAD values of MCDHS treatment were 13.9 and 16.4% lower than those of NBPT treatment at VT and R3 stages, respectively. In deep soil, MCDHS and DMPP tended to present lower SPAD values than NBPT and UREA at later growing stages although only the MCDHS was significantly different at VT stage (on average 11% lower than NBPT and UREA). These differences in SPAD readings can explain some effects of the treatments on maize productive variables (Table 1). NBPT tended to have higher GY and TAB than the other treatments, especially in shallow soils in 2016 (GY 11.3% and TAB 7.8% higher); while MCDHS had the lowest GY and TAB. In spite of this, no significant differences ( $p < 0.05$ ) were found in GY and TAB among treatments in the two seasons and for the two soils. A significant effect of NBPT on grain yield was already described by Abalos *et al.* (2014) in a meta-analysis study. Differences in NUE among treatments were only detected for the shallow soils in 2016 (Table 1); MCDHS had a 19.3% lower NUE than the other treatments which was in concordance with SPAD readings after V13. NBPT and DMPP did not affect NUE, similar to Abalos *et al.* (2014).

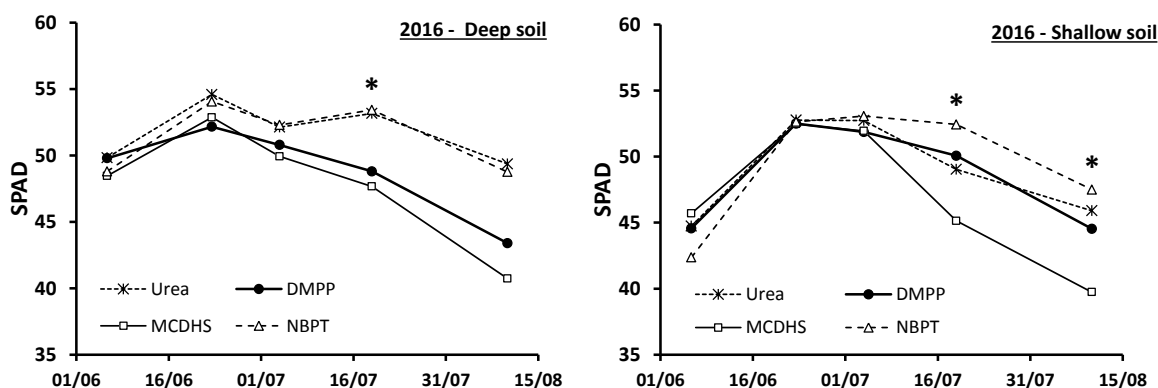

Figure 1. Average ( $n=3$ ) chlorophyll meter readings (SPAD) in different maize stages (V6, V10, V13, VT, and R3) during the 2016 growing season. The asterisk (\*) indicates significant effects of treatments ( $p < 0.05$ ).

Table 1. Average ( $n=3$ ) of productive parameters obtained in the fertilizer treatments and soil types during two seasons.

		2015		2016	
		Deep soil	Shallow soil	Deep soil	Shallow soil
Total N applied, kg ha <sup>-1</sup>		211	236	173	211
Grain yield (14%) (Mg ha <sup>-1</sup> )	Urea	20.9	17.5	17.2	14.6
	DMPP	20.7	18.7	16.3	14.4
	MCDHS	20.1	17.3	16.2	12.4
	NBPT	21.1	19.5	18.0	15.4
	<i>P-value</i>	0.4191	0.0638	0.2928	0.0921
Aerial biomass yield (0%) (Mg ha <sup>-1</sup> )	Urea	34.4	28.7	30.8	26.7
	DMPP	33.9	28.6	30.0	26.6
	MCDHS	33.3	27.7	28.9	23.8
	NBPT	35.3	29.2	31.5	28.1
	<i>P-value</i>	0.3325	0.2385	0.3731	0.0648
Nitrogen use efficiency	Urea	1.28	0.89	2.58	1.77 a
	DMPP	1.19	0.86	2.37	1.68 a
	MCDHS	1.15	0.84	2.40	1.42 b
	NBPT	1.31	0.92	2.68	1.84 a
	<i>P-value</i>	0.2132	0.2630	0.3255	0.0104

## CONCLUSION

The use of DMPP and NBPT allows reducing the number of side-dress N applications in maize without compromising grain yields under good irrigation practices. The novel MCDHS urease inhibitor tended to produce lower yield and NUE than the other treatments, although the differences were not always significant.

**Acknowledgements:** Spanish Ministry of Economy, Industry, and Competitiveness (AGL2013-49062-C4-3-R project) and Spanish National Institute for Agricultural Research (FPI-INIA 2015 predoctoral fellowship).

## REFERENCES

- Abalos, D., Jeffery, S., Sanz-Cobena, A., Guardia, G., Vallejo, A., 2014. Meta-analysis of the effect of urease and nitrification inhibitors on crop productivity and nitrogen use efficiency. *Agric. Ecosyst. Environ.* 189, 136-144.
- Ladha, J.K., Pathak, H., Krupnik, T.J., Six, J., van Kessel, C., 2005. Efficiency of fertilizer nitrogen in cereal production: Retrospect and prospects. *Adv. Agron.*, 87, 85-156.

## **N<sub>2</sub>O EMISSIONS DURING AND AFTER LEGUME CROPS CULTIVATION**

<sup>1</sup>NICOLARDOT, B., <sup>1</sup>BIZOUARD, F., <sup>1</sup>COFFIN, A., <sup>1</sup>GUINET, M., <sup>2</sup>HENAUULT, C., <sup>1</sup>LOMBARD, F.,  
<sup>1</sup>PAUTHENET, G., <sup>1</sup>PIMET, E., <sup>1</sup>VOISIN, A.S.,

<sup>1</sup> UMR Agroécologie, AgroSup Dijon, CNRS, INRA, Université Bourgogne Franche Comté, France, <sup>2</sup> Unité Science du Sol INRA, Orléans, France

### **INTRODUCTION**

Due to their ability to fix atmospheric dinitrogen thanks to symbiosis with soil bacteria, legumes provide a number of ecological services to agroecosystems. Their cultivation results in the harvest of proteins or fodder that are rich in protein, without any N fertilisation; their N rich crop residues left in the soil can be valued by the following crop. Their cultivation thus permits saving the consumption of fossil fuel energy and the emissions of greenhouse effect gas that are associated with the use of nitrogen fertilisers as reported by Rochette & Janzen (2005) and Jeuffroy et al. (2013). However, there is a lack of references on a wide range of legume crops, French research being essentially focused on pea. In the context of a French national research program (ANR Legitimes, 2018), field experiments have been set up to better characterize and quantify services related to N fluxes, for 10 legume species. Here we report first results concerning N<sub>2</sub>O emissions during a two-year legume-cereal rotation: i) first year with different legume crops compared to fertilised cereals, and ii) second year with non-fertilised winter wheat which uptake N mineralised from crop residues coming from previous legume or cereal crops.

### **MATERIALS AND METHODS**

Two field trials were respectively set up in 2014 and 2016 at the INRA experimental site of Bretenière (Eastern France) characterised by a semi-continental climate, the soil being classified as a Cambisol. Each field trial considered a two-year crop rotation (1<sup>st</sup> year including legume crop, followed by intercrop period and sowing of the winter wheat, and a 2<sup>nd</sup> year corresponding to the growth of unfertilised wheat crop until harvest). Legume crops were sown either on March or on May. As pre-crops, they were compared to non-fixing reference crops: Barley and Sorghum that were respectively sown in March and May and were N fertilised (135 and 70 kg N ha<sup>-1</sup> in 2014 and 2016 respectively for barley and 100 kg N ha<sup>-1</sup> for sorghum for both years). The winter wheat crop was sown on October and was not N fertilised. N<sub>2</sub>O emissions were measured continuously using the automated chamber method (Vermue et al., 2013) during the 2-year duration of each trial. Legume crops considered during the first year were lupine, pea, faba bean, common bean, soya bean, chickpea, as well as the non-legume crops (i.e. barley and sorghum). For each treatment, emissions were measured using three automatic chambers. Soil temperature and moisture were continuously recorded for the different systems and soil bulk density and soil inorganic N were periodically measured.

### **RESULTS AND DISCUSSION**

Most of the time for all treatments, daily N<sub>2</sub>O emissions were less than 10 g N-N<sub>2</sub>O d<sup>-1</sup> ha<sup>-1</sup>, which is generally recorded for the pedoclimatic conditions of this experimental site (Vermue et al., 2013, 2016). Higher values (from 10 to 90 g N-N<sub>2</sub>O d<sup>-1</sup> ha<sup>-1</sup>) were measured in summer 2014 and spring 2016, respectively for field trials 1 and 2. These high emissions were related to exceptionally rainy conditions occurring during these two periods. Consequently, for field trial 1, cumulated N<sub>2</sub>O emissions during legume crops cultivation were lower (96 to 411 g N-N<sub>2</sub>O y<sup>-1</sup> ha<sup>-1</sup>) than for intercrop + unfertilized wheat crop cultivation (92 to 487 g N-N<sub>2</sub>O y<sup>-1</sup> ha<sup>-1</sup>). For trial 2 (Figure 1), the contrary is observed with higher cumulated emissions measured during year 1 (legume crop cultivation) and lower cumulated emissions during year 2 (i.e. after incorporation of legume residues in soil and during unfertilized wheat crop). For both trials, higher emissions were measured for both fertilized crops (i.e. barley and sorghum) than for legume crops, especially during the following weeks after N fertilizer application. Consequently, for both trials, cumulated emissions for fertilized crops (barley or sorghum) were higher than respectively



corresponding cumulated emissions for legume crops sown in March or May, which is in accordance to published data (Rochette & Janzen, 2005; Jeuffroy et al., 2013).

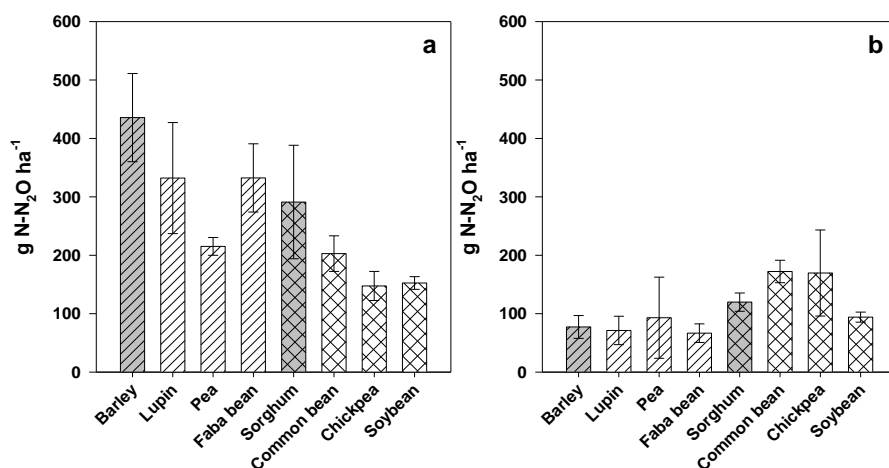

Figure 1. Cumulated N<sub>2</sub>O emissions during 2016-2017 field trial: a) from sowing to harvest of legume crops (first year); b) from legume harvest to following wheat harvest (second year). White bars; legume as crops (a) or –pre crops (b); Grey bars = N-fertilised non-legume crops as crops (a) or pre-crops (b), dashed-line bars = crops sown in March 2016, crossed-line bars = crops sown in May 2016.

## CONCLUSION

N<sub>2</sub>O emissions were first influenced by climatic conditions for both field trials. During the first year of both field trials, N<sub>2</sub>O emitted during legume crops were less than for fertilised crops confirming the interest of legume crop to decrease GES emitted by cropping systems. During the second year of field trials, N<sub>2</sub>O emissions were presumably related to soil N availability, which depends on the amounts of N present in crop residues and their mineralisation dynamics in soil. The next step of our work will consist to simulate N<sub>2</sub>O emissions using emission's models to better precise the microbial processes responsible for emissions (i.e. nitrification and denitrification) and the role of pedoclimatic conditions.

**Acknowledgements:** M. Guinet PhD work was granted by INRA and the Ministry in charge of Agriculture. The experimental work was supported by the ANR LEGITIMES and Bourgogne-Franche-Comté Region (PSDR ProSys project).

## REFERENCES

- ANR Legitimes, 2018. <https://www6.inra.fr/legitimes>.
- Jeuffroy M.H., Baranger E., Carrouée B., de Chezelles E., Gosme M., Hénault C., Schneider A., Cellier P. 2013. Nitrous oxide emissions from crop rotations including wheat, rapeseed and dry peas. *Biogeosciences*, 10, 1787-1797.
- Rochette P., Janzen, H.H., 2005. Towards a revised coefficient for estimating N<sub>2</sub>O emissions from legumes. *Nutrient Cycling in Agroecosystems*, 73, 171-179.
- Vermue A., Philippot L., Munier-Jolain N., Hénault C., Nicolardot B. 2013. Influence of integrated weed management system on N-cycling microbial communities and N<sub>2</sub>O emissions. *Plant Soil*, 373, 501-514.
- Vermue, A., Hénault C., Nicolardot B. 2016. High N<sub>2</sub>O variations induced by agricultural practices in integrated weed management systems. *Agronomy for Sustainable Development* 36, 1-10.

## AN INCUBATION STUDY ABOUT THE POTENTIAL OF HIGH ORGANIC CARBON SOIL AMENDMENTS TO IMPROVE AGRICULTURAL NITROGEN RETENTION CAPACITY

REICHEL R<sup>1</sup>, WEI J<sup>1</sup>, ISLAM M.S.<sup>1</sup>, AMELUNG W.<sup>2</sup>, SCHMID C.<sup>3</sup>, SCHRÖDER P.<sup>3</sup>, SCHLOTTER M.<sup>3</sup>, BRÜGGEMANN N<sup>1</sup>

<sup>1</sup> Forschungszentrum Jülich GmbH, Institute of Bio- and Geosciences, Agrosphere (IBG-3), 52425 Jülich, Germany, <sup>2</sup> Institute of Crop Science and Resource Conservation, Soil Science & Soil Ecology, University of Bonn, 53115 Bonn, Germany, <sup>3</sup> Deutsches Forschungszentrum für Gesundheit und Umwelt GmbH, Research Unit Comparative Microbiome Analysis (COMI), 85764 Neuherberg, Germany

### INTRODUCTION

Nitrogen excess is a persistent problem of intensive agriculture, with consequences for climate change and ground water pollution by N<sub>2</sub>O emission and NO<sub>3</sub><sup>-</sup> leaching, respectively. High organic carbon soil amendments (HCA) with large C:N ratio, such as wheat straw, can stimulate microbial growth only if the microbes take up additional nitrogen from the soil in order to maintain their low C:N ratio. A static laboratory incubation study with custom-made soil columns, containing sieved agricultural sandy loam soil, was established to test the following hypotheses: (1) Can HCA such as wheat straw, spruce sawdust, and lignin help to manage temporal N excess in agricultural soil by inducing microbial growth at a relevant magnitude? (2) Can such HCA application strategies help to improve the nitrogen retention capacity of the soil by reducing an unintended N loss?

### MATERIAL AND METHODS

Soil was sampled near Kiel (Germany) from the top layer of an agricultural field (54°19'05"N, 9°58'38"E). Soil had a pH (CaCl<sub>2</sub>) of 6.0 ± 0.1, a total organic C content of 1.3 %, and contained 0.15 % total N (N<sub>t</sub>). Ammonium sulfate was applied, resembling an N application of 150 kg N ha<sup>-1</sup>. Wheat straw contained 44.4 % C and 0.28 % N. Spruce sawdust had 45.8 % C and 0.06 % total N. Both materials were ground to 1 mm. Lignin with 61.6 % organic C and 0.43 % N. All HCAs were applied at a rate of 1.5 g C kg<sup>-1</sup> soil, equivalent to a field application of 4.5 t C ha<sup>-1</sup>. Three treatments with combined application of N fertilizer and wheat straw (SWF), or spruce sawdust (SSF), or lignin (SLF) were established. The control treatment (S) did not receive any N fertilizer or HCA, the fertilizer control (SF) received only N fertilizer. All treatments were incubated under the same experimental conditions and prepared in triplicate. Seven days prior to N fertilizer application, the first soil column section was sampled as reference, while the following samplings were conducted at 7, 21, 49, 77, and 113 days after fertilizer application (DAF).

For chemical analyses, soil and HCA of litter bags was stored at room temperature after freeze-drying. Decomposition was calculated after determining weight loss between applied and recovered HCA dry matter. Microbial biomass carbon (C<sub>mic</sub>) was determined as described in Reichel et al. (2017). N<sub>mic</sub> was calculated using the C<sub>mic</sub>:N<sub>mic</sub> ratio of 7. Residues of litter bags were washed three times with 1 M KCl at a ratio of 1:5 (w/v) to exclude adsorbed mineral N, before the freeze-dried powder was analyzed for N content (IRMS, Delta V plus, Thermo Fisher 231 Scientific, Bremen, Germany). Results were recalculated on a kilogram per hectare basis using the following input parameters of the field site: 10,000 m<sup>2</sup> × 0.2 m soil depth × bulk density of 1,500 kg m<sup>3</sup> = 3·10<sup>6</sup> kg dry soil ha<sup>-1</sup>.

### RESULTS AND DISCUSSION

Decomposition of OSA in N fertilized soil was reflected by microbial N retention (Fig. 1-A). Microbial biomass of the wheat straw (SWF) treatment retained 8-42 kg N ha<sup>-1</sup>, while in the sawdust treatment (SSF) 6-12 kg N ha<sup>-1</sup> were retained in microbial biomass during the four month of incubation. As expected, pure lignin did not stimulate N immobilization.

Decomposing HCA material of wheat straw and spruce sawdust was enriched with 24 kg N ha<sup>-1</sup> N, which remained in the HCA for more than four months. More about this topic will be available soon (Reichel et al., in revision).

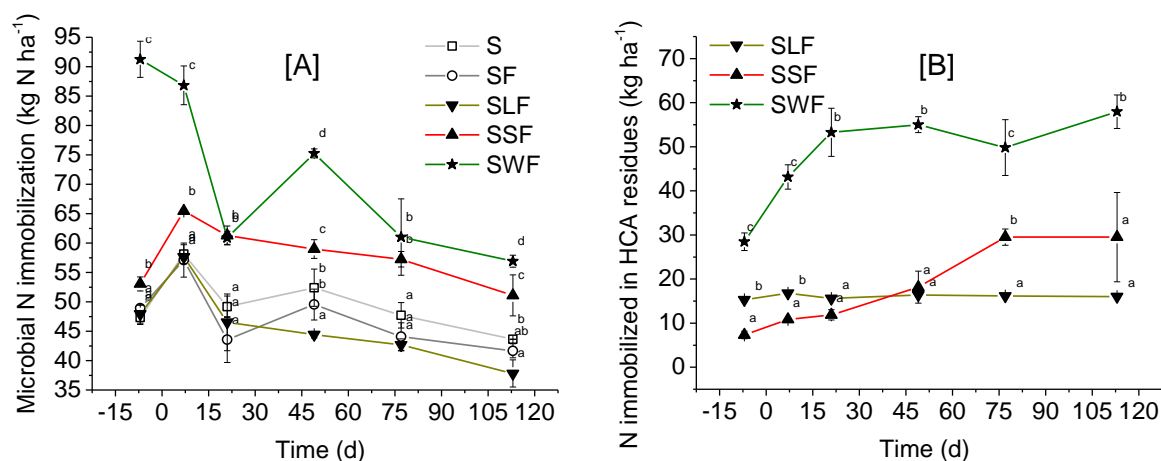

Figure 1. [A] Microbial N immobilization ( $\text{kg N ha}^{-1}$ ), [B] physical and/or chemical N immobilization by the remaining HCA residues in  $\text{kg N ha}^{-1}$  in soil of the control treatment (S, open quadrat; Fig. 1-A) without any fertilizer or HCA, the fertilizer control treatment (SF, open circle; Fig. 1-A) with mineral N fertilizer, and the HCA treatments with mineral N fertilizer plus lignin (SLF, solid triangle downwards), spruce sawdust (SSF, solid triangle upwards), or wheat straw (SWF, solid star symbol). Incubation time  $d = 0$  divides the x-axis into a period before (-7 DBF) and after (7, 21, 49, 77, and 113 DAF) mineral N fertilization. Standard deviations of mean values ( $n=3$ ) are displayed. Statistically significant differences between treatments at a certain incubation time point are depicted by different lowercase letters next to the symbols ( $p < 0.05$ ).

## CONCLUSION

HCA on wheat straw basis can be effective in buffering an excess of N in a short period of time, as often reported for post-harvest sugar beet and oilseed rape fields. The N immobilization benefits might be optimized by combining different HCA with properties of wheat straw and spruce sawdust. These HCA materials retained N long enough within the microbial and HCA residue pool to serve as additional N supply for the subsequent crop. HCA can be part of cultivation strategies to improve N use efficiency of agricultural production. HCA composition, particle size, and adaption to the N fertilization regimes may improve the immobilization and re-release of N at the right time and rate in future.

**Acknowledgements:** We thank Holger Wissel, Franz Leistner, Martina Krause (Forschungszentrum Jülich GmbH, IBG-3) for their technical support, Ayhan Egmen of IBG-2-3-TAK for producing the incubation columns, Steffen Rothardt and Henning Kage at the Christian-Albrechts-Universität zu Kiel (CAU) for the provision of the soil, wheat straw, and spruce sawdust. We also thank the BMBF for funding (FKZ 031A561A).

## REFERENCES

- Reichel R., Hänsch M., Brüggemann N., 2017. Indication of rapid soil food web recovery by nematode-derived indices in restored agricultural soil after open-cast lignite mining. *Soil Biol. Biochem.* 115, 261-264.
- Reichel R., Wie J., Islam M.S., Schmid C., Wissel H., Schröder P., Schloter M., Brüggemann N., in revision. Potential of wheat straw, spruce sawdust, and lignin as high organic carbon soil amendments to improve agricultural nitrogen retention capacity: an incubation study. *Front. Plant Sci.*

## EFFECTS OF LONG-TERM APPLICATION OF MINERAL NITROGEN AND MANURE ON SELECTED SOIL PROPERTIES

PIKUŁA D.<sup>1</sup>, MARTYNIUK S.<sup>2</sup>

<sup>1</sup> Department of plant nutrition and fertilization<sup>1</sup>, department of agriculture microbiology, <sup>2</sup> institute of soil science and plant cultivation – state research institute in puławy, poland

### INTRODUCTION

In the first half of the past century, there were hardly contradictions between the agricultural cultivation and the environment. With the increasing use of mineral fertilizers, yields have increased by more than 100% thus the quantity of roots and harvest residues on the field has increased strongly as a source of organic matter. However, in agricultural practice they are commonly removed from the field after harvest resulting in soil organic matter decrease. It results in declining of soil fertility (Mazzoncini et al.2011).

The aim of this study was to compare selected biological and chemical characteristics soil on which for over 34 years crops were grown in two crop rotations similar with respect to N nitrogen and manure application but differing with respect to total organic matter input (mustard green manure, one year clover-grass ley).

### MATERIAL AND METHODS

The study was conducted on the basis of a three-factor long-term field experiment carried on since 1980 at the Experimental Station Grabów, on a soil classified Albic Luvisol with loamy sand texture. The experiment includes two 4-years crop rotations (I factor) with the following crops: rotation A – maize, winter wheat, spring barley and corn for silage and rotation B – maize, winter wheat, spring barley with undersown clover-grass mixture, clover-grass ley. Manure rates (II factor) was applied in the autumn preceding maize once per 4-year cycle as follows: 0, 20, 40, 60 and 80 t/ha. N fertilizer rates (III factor) (N0, N1, N2 and N3) were assigned to plots within each main plots, that is per manure rate. Total N fertilizer inputs in rotation A were: 0 (N0), 170 (N1), 340 (N2) and 510 (N3) kg N/ha per rotation and in rotation B: 0 (N0), 155 (N1), 310 (N2) and 465 (N3) kg N/ha. For the purpose of this study, in 2013, when winter wheat was grown in both rotations, soil samples were collected from selected treatments to assess the following parameters: microbial biomass (SMBC), the content of the soluble MO fraction (C extracted with hot water) and Corg, pH.

The data were subjected to the 3-way analysis of variance (ANOVA) with significance of differences assessed at  $P < 0.05$ .

### RESULTS AND DISCUSSION

There was found no significant interactions between experimental factors. The soil in rotation B with an increased input of organic matter accumulated significantly larger amounts of soil organic carbon (SOC) and soil microbial biomass (SMBC), but in all other treatments microbial biomass C decreased as N rates increased (*Figure 1*). In general, mineral N fertilization had also a beneficial effect on SOC accumulation. This effect was insignificant when FYM was not applied in rotation A, but in rotation B in the absence of FYM the soil treated with 100 and 150 kg N ha<sup>-1</sup> contained significantly larger amounts of SOC than the unfertilized soil (N-0). When manure was used, application of 150 kg N ha<sup>-1</sup> resulted in the accumulation of the maximum amounts of SOC in both rotation (*Figure 1*). There is also a general consensus that proper soil fertility management practices on croplands, particularly with respect to N fertilization, enhance SOC sequestration and are beneficial for soil microorganisms and their activity, mainly due to a greater return of crop residues to the soil (Liu et al., 2006, Mazzoncini et al., 2011). However, there are also reports showing that mineral N fertilizers, particularly their high rates, can reduce SMBC (Blanchet et al., 2016).

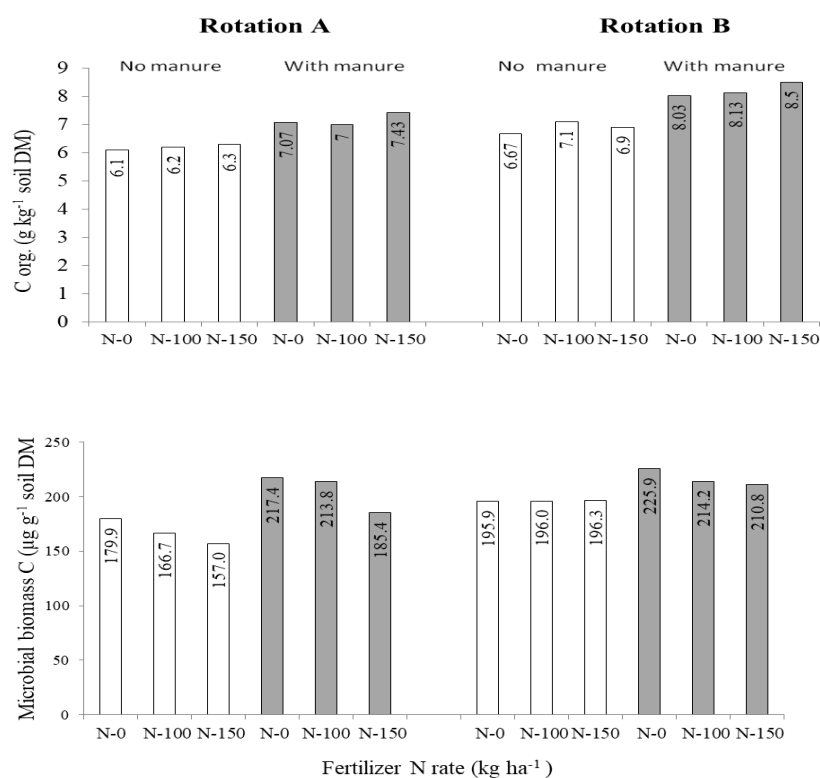

Figure 1. Organic C and microbial biomass C contents in soil as influenced by crop rotation (I), manure application (II) and mineral N rate (III) in a long-term field experiment.  $LSD(P \leq 0.05)$ : for C org.: I = 0.52, II = 0.65, III = 0.23, interactions – not significant; for microbial biomass C: I = 11.5, II = 10.1, III = 11.2, interactions: not significant

## CONCLUSION

All the experimental factors had significant effects of organic C accumulation in soil. Irrespective of fertilizer N rates and manure application, the soil in rotation B with larger organic matter input (mustard green manure, clover-grass ley) contained significantly more C org..

The high rates of mineral N fertilizers can reduce soil microbial biomass.

## REFERENCES

- Blanchet, G., Gavazov, K., Bragazza, I. & Sinaj, S., 2016. Responses of soil properties and crop yields to different inorganic and organic amendments in a Swiss conventional farming system. *Agr. Ecosyst. Environ.* 230, 116–126.
- Liu, X., Herbert, S. J., Hashemi, A. M., Zhang, X. & Ding, G., 2006. Effects of agricultural management on soil organic matter and carbon transformation – a review. *Plant Soil Environ.* 52, 531–543.
- Mazzoncini, M., Sapkota, T. B., Barber P., Antocji, D. & Risaliti R., 2011. Long-term effect of tillage, nitrogen fertilization and cover crops on soil organic carbon and total nitrogen content. *Soil Till. Res.* 114, 165–174.

## SHORT-TERM FATE OF $^{15}\text{N}$ IN MAIZE ON TROPICAL SANDY SOILS AS AFFECTED BY N FORM, TILLAGE AND BIOCHAR ADDITION

MUNERA-ECHEVERRI, J.L.<sup>1</sup>, MARTINSEN, V.<sup>1</sup>, OBIA, A.,<sup>2</sup>DÖRSCH, P.<sup>1</sup>, MULDER, J.<sup>1</sup>

<sup>1</sup> Faculty of Environmental Sciences and Natural Resource Management, Norwegian University of Life Sciences, Norway; <sup>2</sup> Norwegian Geotechnical Institute (NGI), Norway

### INTRODUCTION

Maize productivity in Sub-Saharan Africa (SSA) is often low due to erratic rainfall and the inherent low nutrient content of soils. Crop yields were shown to respond positively to nitrogen (N) fertilization (Palm et al., 2010). However, the high cost of fertilizers limits widespread use on smallholder farms. Therefore, strategies to reduce N losses and to optimize N uptake by crops are important for crop productivity and food security. So far, few studies in SSA have focused on the effect of tillage practice and type of N fertilizer on N use efficiency and crop yield on smallholder farms. Here, we investigated effects of conventional tillage and minimum tillage (using planting basins with and without application of biochar) on assimilation, retention and losses of N in maize on sandy soil at Kaoma, Zambia. The study involved biochar from pigeon pea and included tests with three  $^{15}\text{N}$  labeled forms of N ( $\text{NO}_3^-$ ,  $\text{NH}_4^+$  and Urea). Understanding how the fate of  $^{15}\text{N}$  is affected by soil management practices and the form of N added is important for providing farmers with recommendations on how to make a better use of N, in which losses are minimized and plant uptake optimized.

### MATERIAL AND METHODS

Three soil management practices were assessed in triplicates in 20m<sup>2</sup> plots, each with 7 rows with a spacing of 90 cm. Tillage practices included 1) Conventional: overall ploughing without residue retention, with 12 plants per row and 21 cm between plants. 2) Conservation agriculture: 4 planting basins per row (20 x 30 cm), 70 cm between basins, 3 plants per basin and residue retention between basins. 3) Conservation farming and biochar, with the same treatment as the previous one, but now with 250 g of biochar per basin (this is equivalent to 4 ton ha<sup>-1</sup>). All plots received the same amount of NPK (10:20:10) fertilizer at planting (250 kg ha<sup>-1</sup>). Seven weeks after planting a  $^{15}\text{N}$  labelling experiment with the addition of 96 g  $^{15}\text{N}$  ha<sup>-1</sup> in the form of  $^{15}\text{NH}_4\text{NO}_3$ ,  $\text{NH}_4^{15}\text{NO}_3$  and  $^{15}\text{N}$ -Urea was established in the field. Water was included as a non-labelled control.

Three  $^{15}\text{N}$  forms were applied dissolved in water and a control with the same amount of water was included. The four  $^{15}\text{N}$  treatments were applied in every plot, each  $^{15}\text{N}$  form in two basins per row. Thus, keeping one non-labeled row in between labelled rows, to avoid cross contamination. Two basins with three healthy plants were chosen. In the conventional plots, the  $^{15}\text{N}$  tracers were applied to 10 cm wide strips of 60 cm length, with 3 plants in each. In all the treatments, the  $^{15}\text{N}$  label was applied in solution to 1200 cm<sup>2</sup> of soil. The addition of  $^{15}\text{N}$  was small compared to the initial fertilizer dose amounting to 96 g  $^{15}\text{N}$  ha<sup>-1</sup> as  $^{15}\text{NH}_4\text{NO}_3$ ,  $\text{NH}_4^{15}\text{NO}_3$  and  $^{15}\text{N}$ -Urea, respectively.

After 240 hours, soil samples were taken from 0 to 5 cm and 5 to 20 cm depth and extracted on site using 1 M KCl. The extracts were analysed for  $\text{NO}_3^-$  and  $\text{NH}_4^+$ . Plant samples were divided into roots stems and new leaves and analysed for delta  $^{15}\text{N}$ . Gas flux measurements were done 24 hours before  $^{15}\text{N}$  addition, 0.5, 24, 48, 72, 120 and 240 hours after. Isotope analysis was done in soil, KCl extractable  $\text{NO}_3^-$  and plant samples.

### RESULTS AND DISCUSSION

The soil  $\text{pH}_{\text{H}_2\text{O}}$  was 6.2, the organic carbon content was 0.5%, and total N was 0.05%. The soil was sandy (89% sand and 3.5% clay). The precipitation during the 10 days of the experiment was 116mm. The residual soil recovery after 10 days was significantly different between the 3 forms of  $^{15}\text{N}$  added, being the highest when  $^{15}\text{N}$ - $\text{NH}_4^+$  (71%) was added, followed by  $^{15}\text{N}$ -Urea (55.8%) and  $^{15}\text{N}$ - $\text{NO}_3^-$  (21.7%). In contrast, the residual soil recovery was

not affected by the three soil management practices (CF + Biochar: 50%; CF Normal: 47%; Conventional: 50%). Very few  $^{15}\text{N}$  was found in the KCl extractable  $\text{NO}_3^-$ . At the depth 5 to 20cm, it was the highest in CF + biochar (0.72%), followed by conventional (0.22%) and CF Normal (0.1%). In contrast, at 0 to 5cm depth, the recovery was neither affected by soil management practices nor the form of added N. Fluxes of  $\text{N}_2\text{O}$  were very small and the contribution of  $\text{N}_2\text{O}$  to  $^{15}\text{N}$  fluxes was small. The recovery in plants was significantly smaller in the Conventional treatment (3.9%) than in CF Normal (14.6%) and CF + Biochar (13.5%). Plant recovery was lower in  $^{15}\text{N}$ -Urea (6.4%) was applied than  $^{15}\text{N}$ - $\text{NO}_3^-$  (14.3%) and  $^{15}\text{N}$ - $\text{NH}_4^+$  (11.3%)

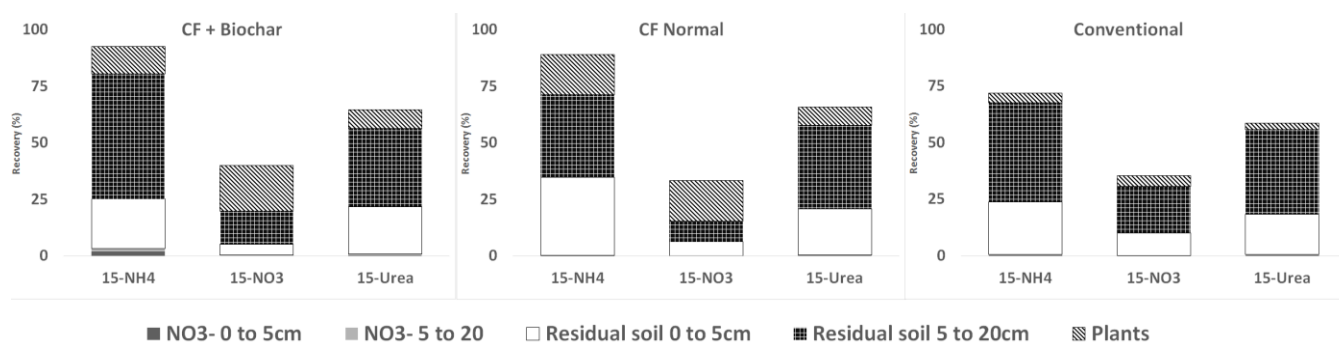

Figure 2.  $^{15}\text{N}$  recovery (%) in soil and KCl extractable  $\text{NO}_3^-$  from 0 to 5 cm and 5 to 20cm and maize plants after 10 days of  $^{15}\text{N}$  tracer addition in three soil management practices.

In this study, the greatest  $^{15}\text{N}$  losses occurred in the  $^{15}\text{N}$ - $\text{NO}_3^-$  treatments, mostly through leaching. The  $^{15}\text{N}$ -Urea treatments also had substantial N losses, most likely due to ammonia ( $\text{NH}_3$ ) volatilization and conversion of urea into  $\text{NO}_3^-$ . Unfortunately, we do not have results of  $\text{NH}_3$  fluxes to compare which mechanism was more important. The low N losses for the  $^{15}\text{N}$ - $\text{NH}_4^+$  treatments can be explained by preference of microbes for this N form (Recous & Mary, 1990) and higher adsorption to soil particles. Biochar increased the recovery of  $^{15}\text{N}$  in the  $\text{NO}_3^-$  pool and reduced plant  $^{15}\text{N}$  uptake and residual soil recovery. The Conventional treatment had the lowest  $^{15}\text{N}$  recovered in plants among the soil management practices, but it might be related to the fact that only half of the rooting environment was covered with the  $^{15}\text{N}$  solution in the Conventional treatment, while for the CF treatments it was completely covered

## CONCLUSION

In this sandy soil N losses were greatly affected by the N form, being the highest when  $^{15}\text{N}$ - $\text{NO}_3^-$  was applied, followed by  $^{15}\text{N}$ -Urea and  $^{15}\text{N}$ - $\text{NH}_4^+$ . Soil management practices marginally affected N losses. Biochar increased the amount of KCl extractable  $\text{NO}_3^-$ . Crop showed a preference of  $^{15}\text{N}$ - $\text{NO}_3^-$  followed by  $^{15}\text{N}$ - $\text{NH}_4^+$  and  $^{15}\text{N}$ -Urea. The low  $^{15}\text{N}$  recovery in plants in the Conventional treatment may be due to an artifact of the application.

## REFERENCES

- Palm, C. A., Smukler, S. M., Sullivan, C. C., Mutuo, P. K., Nyadzi, G. I., & Walsh, M. G. (2010). Identifying potential synergies and trade-offs for meeting food security and climate change objectives in sub-Saharan Africa. *Proc Natl Acad Sci U S A*, 107(46), 19661-19666. doi:10.1073/pnas.0912248107
- Recous, S., & Mary, B. (1990). Microbial Immobilization of Ammonium and Nitrate in Cultivated Soils. *Soil Biol. Biochem.*, 22(7), 913-922.

## EFFECT OF FERTILIZER N FORMS ON ROOT GROWTH IN WINTER WHEAT (*TRITICUM AESTIVUM* L.)

KIRSCHKE, T.<sup>1</sup>, THIEL, E.<sup>2</sup>, CHRISTEN, O.<sup>3</sup>

<sup>1</sup> Institute of Agrochemistry Piesteritz e.V. (AIP), AN-Institute of the University of Halle-Wittenberg, Germany; <sup>2</sup> SKW Stickstoffwerke Piesteritz GmbH, Germany; <sup>3</sup> University of Halle-Wittenberg, Institute of Agricultural and Nutritional Sciences, Halle (Saale), Germany

### INTRODUCTION

Urea is the most widely used nitrogen (N) fertilizer worldwide (IFA, 2017). It undergoes rapid hydrolysis in soil, after which ammonium ( $\text{NH}_4^+$ ) is oxidized to nitrate ( $\text{NO}_3^-$ ).  $\text{NO}_3^-$  leaching from arable land might have significant environmental impact on ground- and surface water (Widdison and Burt, 2008). Due to the use of nitrification inhibitors, the importance of  $\text{NH}_4^+$  as N source for plant nutrition has increased. Different studies demonstrated that an  $\text{NH}_4^+$ -N based fertilizer induces divergent responses in the rhizosphere, compared to a  $\text{NO}_3^-$ -N fertilizer (Ruan et al., 2007), and e.g. promotes branching of taproots under laboratory conditions (Lima et al., 2010). Effects on root growth due to a prolonged  $\text{NH}_4^+$ -N phase are yet not well understood under field conditions. The aim of this study was to close the existing gap in knowledge between laboratory and field scale.

### MATERIAL AND METHODS

A field trial at the experimental farm in Merbitz (average annual precipitation 546 mm; average annual temperature 9.8 °C, Saxony-Anhalt, Germany) was realized in 2014–2016. The winter wheat (*Triticum aestivum* L.) crop was cultivated following spring barley (*Hordeum vulgare* L.). The soil was classified as a Chernozem from loess with a silty loam sand texture. The experimental setup showed a completely randomized design with three treatments and four replications. An unfertilized control and two different N fertilizers were tested: granular calcium ammonium nitrate (CAN) and a granular urea combined with an urease (UI) and nitrification inhibitor (NI) (urea+UI+NI). The N-application rate was 180 kg N ha<sup>-1</sup>. CAN fertilizer was applied in three applications of 60 kg N ha<sup>-1</sup> each time at the beginning of growing season, at growth stage (GS) 31 and at late dressing (GS 51). Urea+UI+NI was applied in two split applications of 100 kg N ha<sup>-1</sup> at beginning of growing season (coincident with 60 kg N ha<sup>-1</sup> CAN), and 80 kg N ha<sup>-1</sup> at GS 37. Wheat roots were sampled by the auger method at GS 32, 37 and 65. The soil monoliths (80 cm in deep and 9.3 cm in diameter) were subdivided into 20 cm segments. The root samples were washed free from soil on 2-mm mesh sieves. The Root length density (RLD) was measured using WinRHIZO® software (Regent Instr. Canada Inc., 2013). According to dry soil conditions in May and June, roots could be sampled at GS 65 only until 40 cm soil depth in 2014. No sampling could be realized at GS 65 in 2015. Data were subjected to analysis of variance using the F-test ( $p < 0.05$ ) to examine the effects of N fertilizer and N form on root growth.

### RESULTS AND DISCUSSION

The high fertility of the soil was demonstrated by high soil mineral N contents in the unfertilized control in every single year. Different  $\text{NH}_4^+$ -concentrations were produced by the used fertilizer N forms. However, the majority of the mineral N were always available as  $\text{NO}_3^-$ . In all treatments and years, RLD decreased with increasing soil depth at each GS (Fig. 1), while constantly more than 40 % of quantified roots were measured in 0–20 cm depth. Including the soil depth 20–40 cm mostly about 75 % of the captured roots were present in the topsoil (0–40 cm). The two examined N forms caused only slightly differences in RLD. However, urea+UI+NI induced in general higher RLD at the GS 37, compared to CAN. Meanwhile the values of both treatments were almost at the same level at GS 65 (maximum root expansion). Significant differences between these treatments were measured only at GS 37 in 2014 in favor of urea+UI+NI. A treatment without N fertilizer application (control) increased rooting at GS 32, but led partially to significant lower RLD during the growing season at 0–20 cm depth (GS 65). Taking all years into consideration, the control variant was characterized by significant lower RLD (0–80 cm summed) at the GS 65, in comparison to both fertilized treatments (data not shown).



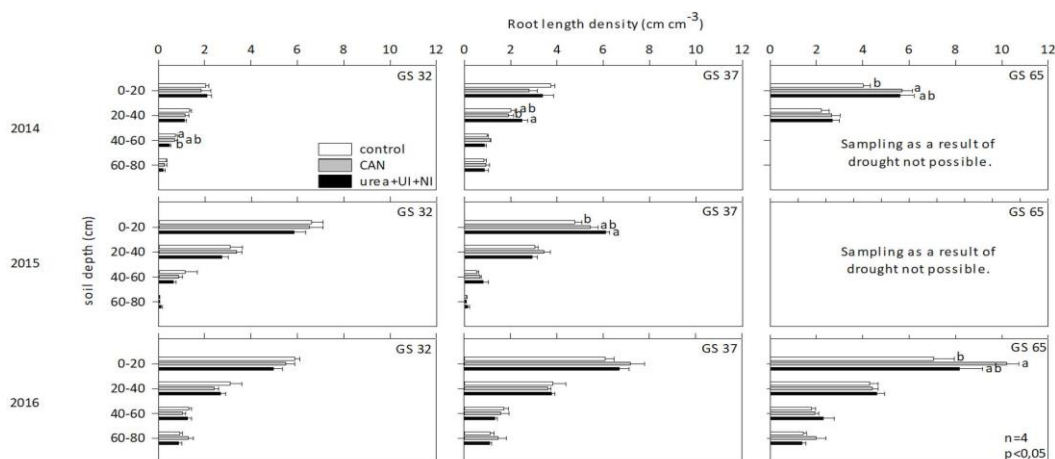

Figure 1. Root length density of winter wheat at treatments with two different fertilizer N forms and one unfertilized control in different soil depths at the growth stages (GS) 32, 37 and 65 in the years 2014, 2015 and 2016. Bars represent mean values (+ SE) of four replicates per treatment, and different letters denote significant differences among means within one depth and one year at  $p < 0.05$  ( $F$  test).

Clear positive effects of an  $\text{NH}_4^+$  based N fertilizer on root growth of *Arabidopsis* under laboratory conditions described by Lima et al. (2010), couldn't be documented in this field study. We realized less pronounced and only temporarily effects of the different fertilizer N forms on winter wheat rooting. This is primarily due to high  $\text{NH}_4^+$ -concentrations under lab conditions (nutrient solution), which is generally not achieved at field scale.

## CONCLUSION

The results showed no statistically significant differences of RLD between the tested different N form treatments. The  $\text{NH}_4^+$  based fertilizer tended to increase promote root growth during stem elongation (GS 37), while an  $\text{NO}_3^-$  emphasised fertilizer have a more positive affect on rooting between GS 37 and flowering (GS 65). In our experiment, a two-splitted fertilizer strategy (urea+UI+NI) nevertheless obtained similar plant root growth as it achieved by a three-divided application (CAN). A scarcity on N (control) tended to stimulate root growth of young plants (GS 32), but generated declines during the growing season.

**Acknowledgement.** Participation in the 20<sup>th</sup> N Workshop was funded by the State Saxony-Anhalt and the European Union.

## REFERENCES

- IFA, 2017. International Fertilizer Industry Association, Production and International Trade [https://www.fertilizer.org/En/Statistics/PIT\\_Excel\\_Files.aspx](https://www.fertilizer.org/En/Statistics/PIT_Excel_Files.aspx) (accessed 17. Jan. 2018)
- Lima J.E., Kojima S., Takahashi H., von Wirén N., 2010. Ammonium triggers lateral root branching in *Arabidopsis* in an AMMONIUM TRANSPORTER1;3-dependent manner. *The Plant cell* 22 (11), 3621–3633.
- Ruan J., Gerendás J., Hårdter R., Sattelmacher B., 2007. Effect of nitrogen form and root-zone pH on growth and nitrogen uptake of tea (*Camellia sinensis*) plants. *Annals of botany* 99 (2), 301–310.
- Widdison P. E., Burt T.P., 2008. Nitrogen cycle. *Global Ecol*, 2526–2533.

## EFFECT OF N-FERTILIZERS ON THE ABUNDANCE OF NITRIFICATION AND DENITRIFICATION GENES IN BULK AND RHIZOSPHERIC SOIL OF TOMATO AND BEANS PLANTS

CASTELLANO-HINOJOSA, A.<sup>1,2</sup>, GONZÁLEZ-LÓPEZ, J.<sup>1</sup>, BEDMAR E.J.<sup>2</sup>

<sup>1</sup> Department of Microbiology, Faculty of Pharmacy, University of Granada, Granada, Spain; <sup>2</sup> Estación Experimental del Zaidín, Granada, Spain.

### INTRODUCTION

Nitrogen availability is a major limiting factor for plant growth and crop production. Root exudates and specially application of N-fertilizers from agricultural practices increase the N concentration in the soil. The effect of N-fertilizers on nitrification and denitrification gene abundances has been reported in bulk soil (Hallin et al., 2017), but comparative data on bulk and rhizospheric soil are scarce. Here we report the abundance of nitrification and denitrification genes in bulk and rhizospheric soil of tomato and common bean grown in an agricultural soil.

### MATERIALS AND METHODS

#### Sampling site and experimental setup

Samples from a eutric cambisol soil were collected from an agricultural area located near Motril (Granada, Spain) and supplemented independently either with urea, ammonium sulfate or potassium nitrate and mixed with a concrete mixer. Final concentration was of 260 kg of equivalent N ha<sup>-1</sup>. A set of pots containing soil without fertilization was used as a control. Fertilized soils were used to fill 20-kg capacity containers (54 x 21 x 25 cm, 4 pots/treatment), then planted with either tomato (*Solanum lycopersicum* var. Roma) or common bean (*Phaseolus vulgaris* var. Kylie) and maintained under greenhouse conditions. Soils were watered every week to about 80% water filled pore space (WFPS). A set of pots containing soil without fertilization was used as a control. Four consecutive crops were recorded. The concentration of each fertilizer was determined at the end of each crop (about 4 months/crop) and when required, the soil was supplemented with the corresponding N-fertilizer to reach the initial fertilization rate. Total organic carbon (TOC), total nitrogen (TN), pH and NO<sub>3</sub><sup>-</sup> and NH<sub>4</sub><sup>+</sup> contents were determined along the experimental period.

#### Nitrous oxide emission

To assay N<sub>2</sub>O emissions stainless steel cylindrical corers (5 x 20 cm) were manually inserted into the ground to sample soil. Measurements were performed 24 h after watering of the pots by gas chromatography. Cumulative N<sub>2</sub>O emissions were calculated by linear interpolation between gas sampling periods.

#### DNA extraction and quantification of nitrification and denitrification genes

Soil samples (5 g) from both bulk and rhizospheric soil were taken and total DNA extracted according to Correa-Galeote et al. (2014). The total bacterial (16SB) and archaeal (16SA) communities were quantified by qPCR using the 16S rRNA gene as molecular marker. The size of the nitrifiers was estimated by using the *amoA* gene from ammonia oxidizing bacteria (*amoA* AOB) and archaea (*amoA* AOA) and that of the denitrifiers by determination of the *napA/narG*, *nirK/nirS*, *norB* and *nosZI/nosZII* genes.

#### Statistical analyses

Stepwise multiple regression analysis was performed to assess the abiotic variables (targeted genes) in both bulk and rhizospheric soil of tomato and common bean plants. For each crop, Mantel test was employed to correlate abiotic properties, plant type and targeted genes.

### RESULTS AND DISCUSSION

### Soil properties and nitrous oxide emissions

Values of pH were significantly higher in the rhizospheric soil of each tomato and common bean plants under all conditions examined. Regardless of the plant species and the N-treatment, while the ammonium detected in the bulk soil was statistically higher than that in the rhizospheric soil for the 4 consecutive crops, the content of nitrate was lower. Also, rhizospheric soil contained more TOC and TC and less TN. After N-fertilization, N<sub>2</sub>O fluxes increased to reach a peak 20 d after fertilizers application. Afterwards, gas emission gradually decreased to a basal level. For the two plant species and each of the 4 crops, maximal N<sub>2</sub>O fluxes were found after urea application, followed by treatment with ammonium and, finally, nitrate (Fig. 1). After 4 consecutive crops, the cumulative N<sub>2</sub>O emissions (kg N ha<sup>-1</sup>) for soils cultivated with common bean and tomato were 16.43 vs 11.97, 12.48 vs 10.56 and 3.31 vs 2.70 for urea, ammonium and nitrate, respectively.

### Abundance of nitrification and denitrification genes

For each of the 2 plants and the 4 crops, total abundance of 16SB and 16SA were higher in the rhizospheric soil regardless of the N treatment. While the *amoA* AOB gene copy number was more abundant in the rhizospheric soil, the *amoA* AOA was higher in the bulk soil. Also, all of the 7 denitrification genes showed higher abundance in the bulk soil. Moreover, all targeted genes showed higher abundance in soils cultivated with common bean.

### Multivariate relationships

A stepwise multiple regression analysis showed that the changes in the abundance of the 16S rRNA genes were explained mainly by TC and TOC in the bulk and the rhizospheric soil of each plant species. The abundance of the nitrification genes was significantly affected by NH<sub>4</sub><sup>+</sup> and TN in the bulk soil and by pH and NH<sub>4</sub><sup>+</sup> in the rhizospheric soil. Shifts in the biomass of the denitrification genes were mainly controlled by NO<sub>3</sub><sup>-</sup> and pH in the bulk soil and by NO<sub>3</sub><sup>-</sup> and TN in the rhizospheric soil. Mantel tests showed that plants influenced the abundance of targeted genes in the rhizospheric soil. N-fertilization induced an increase of the *nosZ* genes that was coupled to the reduction of N<sub>2</sub>O emissions (Fig. 1).

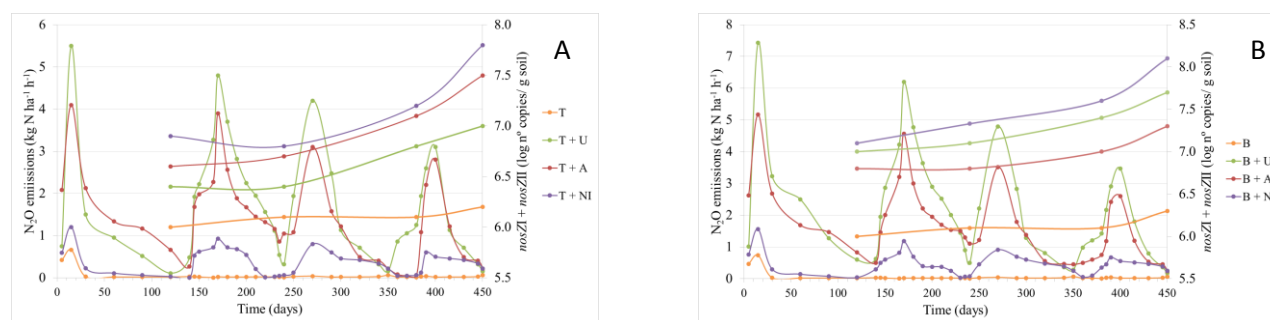

Figure 1. N<sub>2</sub>O emissions (kg N ha<sup>-1</sup> h<sup>-1</sup>) by soils treated with urea (U), ammonium sulphate (A) or potassium nitrate (NI) cultivated with either tomato (T, Fig. 1A) or common bean (B, Fig. 1B) during four consecutive crops (4 months each). Total abundance (log gene copy number/g soil) of *nosZ* + *nosZII* genes is also shown.

**Acknowledgements:** This study was supported by the ERDF-cofinanced grant PEAGR2012–1968 from Consejería de Economía, Innovación y Ciencia. ACH thanks MECD for FPU grant FPU2014/01633.

### REFERENCES

- Correa-Galeote, D., Tortosa, G., Bedmar, E.J. 2014. Quantification of functional microbial nitrogen cycle genes in environmental samples. In: D.E. Marco (ed.) *Metagenomics of the Microbial Nitrogen Cycle: Theory, Methods and Applications*. Caister Academic Press, Norwich, UK, pp. 65-85.
- Hallin, S., Philippot, L., Löffler, F.E., Sanford, R.A., Jones, C.M. 2017. Genomics and ecology of novel N<sub>2</sub>O reducing microorganisms. *Trends in Microbiology*, 26, 43-55.

## CAN N<sub>2</sub>O ISOTOPOCULES HELP TO IMPROVE OUR UNDERSTANDING OF N<sub>2</sub>O PROCESSES DURING GRASSLAND CONVERSION TO MAIZE CROPPING?

BUCHEN, C.<sup>1,2</sup>, LEWICKA-SZCZEBAK, D.<sup>2</sup>, HELFRICH, M.<sup>2</sup>, FLESSA, H.<sup>2</sup>, WELL, R.<sup>2</sup>

<sup>1</sup> Leibniz Centre for Agricultural Landscape Research (ZALF), Germany, <sup>2</sup> Thünen Institute of Climate-Smart Agriculture, Germany

### INTRODUCTION

During the last decades, large areas of grassland were converted to cropland across Europe, mainly due to the increasing demand of cropland following the expansion of biogas plant production (e.g. maize). However, the break-up of permanent grassland is associated with the release of large amounts of carbon (C) and nitrogen (N) caused by an increased mineralisation due to decomposition of soil organic matter and the old grass sward. This additional supply of mineral N can cause enhanced N losses in form of nitrous oxide (N<sub>2</sub>O), an important greenhouse gas. Until now, knowledge about N<sub>2</sub>O production pathways due to grassland break-up and in particular N<sub>2</sub>O reduction to N<sub>2</sub> is very limited, even though understanding of N<sub>2</sub>O processes and identification of sources are needed in order to devise mitigation options. Therefore, natural abundance stable isotope signatures of soil-emitted N<sub>2</sub>O ( $\delta^{15}\text{N}^{\text{bulk}}_{\text{N}_2\text{O}}$ ,  $\delta^{18}\text{O}_{\text{N}_2\text{O}}$  and  $\delta^{15}\text{N}^{\text{SP}}_{\text{N}_2\text{O}}$  = intramolecular distribution of <sup>15</sup>N in the N<sub>2</sub>O molecule) were used to identify sources of N<sub>2</sub>O emission during the first year after grassland conversion to maize cropping.

### MATERIAL AND METHODS

#### Study sites and N<sub>2</sub>O sampling

N<sub>2</sub>O isotopocule samples were collected periodically from manual chambers and analysed by isotope ratio mass spectrometry (IRMS) on four study sites with varying soil texture (sandy to clayey) and different annual N<sub>2</sub>O emission in the north-western part of Germany (Table 1; Buchen et al. (2017)).

Table 1: Site characteristics and annual N<sub>2</sub>O emission within the first year following grassland conversion to maize cropping

Study sites	Soil type	Soil texture	Sward age [year]	N fertilisation rate [kg N ha <sup>-1</sup> year <sup>-1</sup> ]	Treatment	N <sub>2</sub> O emission [kg N ha <sup>-1</sup> year <sup>-1</sup> ]
Oldenburg	Histic Gleysol	Peat-silty sand	> 15	150	Chemical + Mechanical	3.3±1.2
	Plaggic Anthrosol	Sand				1.5±0.1
Trenthorst	Planosol	Sandy loam	> 25	none	Chemical	7.5±1.0
					Mechanical	8.1±1.3
Kleve	Fluvic Cambisol	Clayey loam	> 35	137	Chemical	27.9±2.4
					Mechanical	15.9±3.0

#### N<sub>2</sub>O isotopocule mapping approach

By using a novel isotopocule mapping approach (plotting  $\delta^{15}\text{N}^{\text{SP}}_{\text{N}_2\text{O}}$  vs.  $\delta^{18}\text{O}_{\text{N}_2\text{O}}$ ) based on the isotopic composition of N<sub>2</sub>O produced and literature values for specific N<sub>2</sub>O pathways, we were able to simultaneously determine the contributions of N<sub>2</sub>O production pathways: (i) heterotrophic bacterial denitrification and/or nitrifier denitrification and (ii) nitrification and/or fungal denitrification and the contribution of N<sub>2</sub>O reduction (Lewicka-Szczebak et al., 2017). We calculated two main scenarios with different assumptions for N<sub>2</sub>O produced: N<sub>2</sub>O is reduced to N<sub>2</sub> before residual N<sub>2</sub>O is mixed with N<sub>2</sub>O of various sources (Scenario a) and vice versa (Scenario b) (Figure 1).

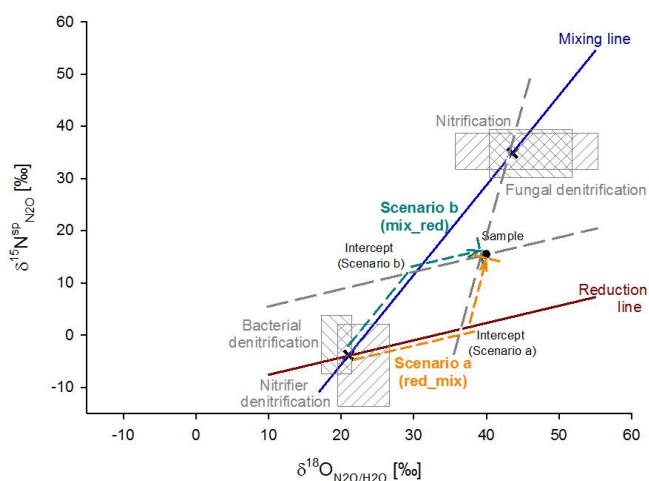

Figure 1: Isotopocule map, illustrating the simultaneous estimation of  $N_2O$  reduction and the contribution of different processes to soil-emitted  $N_2O$

## RESULTS AND DISCUSSION

The isotopic composition of soil-emitted  $N_2O$  largely resembled the known end-member values for bacterial denitrification. The isotopocule mapping approach indicated a different impact of  $N_2O$  reduction on isotopic composition of soil-emitted  $N_2O$  for the four soils under study. For the two sites in Oldenburg, differing  $N_2O$  production pathways within the season were not observed, but management events and soil conditions had a significant impact on pathway contribution and  $N_2O$  reduction. The Kleve site exhibited a close correlation between  $\delta^{15}N_{N_2O}$  and  $\delta^{18}O_{N_2O}$  suggesting that values were mainly controlled by  $N_2O$  reduction to  $N_2$ . At the Trenthorst site (organic farming) this pattern was less pronounced, possibly because processes other than bacterial denitrification (e.g. fungal denitrification and nitrification) also influence isotopocule values.

## CONCLUSION

The applied isotopocule mapping approach opens up new prospects for studying  $N_2O$  production and consumption of  $N_2O$  in soil simultaneously. Bacterial denitrification was found to be the most important process following grassland conversion to maize cropping and the extent of  $N_2O$  reduction depended on the soil type.  $N_2O$  reduction was very variable, partially very high resulting in large  $N_2$  fluxes. However, future attempts are needed in order to properly validate the isotopocule mapping approach.

**Acknowledgements:** The studies were funded by the DFG Research Training Group 1397. We thank all our partners from the Thünen Institute of Organic Farming, as well as the Chambers of Agriculture in Oldenburg and Kleve.

## REFERENCES

- Buchen, C., Well, R., Helfrich, M., Fuß, R., Kayser, M., Gensior, A., Benke, M., Flessa, H., 2017. Soil mineral N dynamics and  $N_2O$  emissions following grassland renewal. *Agriculture, Ecosystems & Environment* 246, 325-342.
- Lewicka-Szczebak, D., Augustin, J., Gieseemann, A., Well, R., 2017. Quantifying  $N_2O$  reduction to  $N_2$  based on  $N_2O$  isotopocules – validation with independent methods (helium incubation and  $^{15}N$  gas flux method). *Biogeosciences* 14, 711-732.

## IS SOYBEAN YIELD LIMITED BY NITROGEN SUPPLY?

CAFARO LA MENZA, N.<sup>1</sup>, MONZON, J.P.<sup>2</sup>, SPECHT, J. E.<sup>1</sup>, GRASSINI, P.<sup>1</sup>

<sup>1</sup> University of Nebraska-Lincoln, USA; <sup>2</sup> Consejo Nacional de Investigaciones Científicas y Técnicas (CONICET), Argentina

### INTRODUCTION

Soybean has a large nitrogen (N) requirement: about 80 kg of N uptake are needed per Mg of seed yield produced (Salvagiotti et al., 2008). Hence, a soybean crop that produces 3 Mg ha<sup>-1</sup> requires *ca.* 240 kg N ha<sup>-1</sup>, while a high-yield soybean crop that produces 6 Mg ha<sup>-1</sup> requires about 480 kg N ha<sup>-1</sup>. Soybean rarely receives N fertilizer inputs, except for a small amount ( $\approx$ 20 kg ha<sup>-1</sup>) typically applied as ‘starter’ at sowing. Hence, soybean relies on two major sources of indigenous N: soil organic matter mineralization and biological fixation. To sustain yield increases, it seems critical to know the yield level at which contribution of indigenous N sources becomes insufficient to meet crop N requirements while still maintaining or increasing seed protein and oil concentration. The objective of this study was to evaluate the degree of N limitation in field grown soybean across a wide range of yield potential of the production environment.

### MATERIALS AND METHODS

It is difficult to evaluate N limitation in soybean for two major reasons. First, soybean uptakes 60% of the N after R3 stage<sup>†</sup> (Bender et al., 2015). Second, application of N fertilizer in soybean typically results in a decrease in N fixation. In order to assess soybean N limitation, we designed an experiment that included: (i) a “full-N” treatment that received an ample N supply during the entire soybean growing season, and (ii) a “zero-N” treatment that did not receive any N fertilizer, relying on indigenous N supply. Experiments were conducted at four sites in Nebraska (USA) during one season (2016) and in Balcarce (Argentina) during two crop seasons (2014/2015 & 2015/2016). Experiments in USA were replicated at four producer irrigated high-yield fields that included the two N treatments following a randomized complete design, while experiments in Argentina consisted of a combination of sowing date, variety, and N treatments following a split-split plot design. In all experiments, crops were irrigated and managed to ensure optimal water and nutrient supply (except for N in the zero-N treatment) and to avoid stress from weeds, insects and pathogens. Experiments covered a wide yield range, from 2.5 to 6.5 Mg ha<sup>-1</sup> (at standard 13% seed moisture content).

We developed a novel N fertilization protocol to ensure non-N limiting conditions in field-grown soybean. Applied N fertilizer in the full N treatment was determined based on (1) a site-specific simulated yield potential of each environment, (2) a soybean N requirement (80 kg N per Mg), and (3) a N fertilizer recovery efficiency of 70-90% depending upon site. N input from fixation and soil organic matter mineralization were ignored in these calculations because of the ‘trade-off’ between N fertilizer application and N fixation and uncertainty in N supply from mineralization. To ensure proper synchronization between N supply and crop N demand during the entire growing season, the total amount of N fertilizer was split in five times, and proportionally adjusted to the expected accumulated crop N uptake at each stage: 10% at V2, 10% at V4, 20% R1, 30% at R3, and 30% at R5<sup>†</sup> (Bender et al., 2015). Seed yield, protein and oil concentration, aboveground dry mater at physiological maturity (ADM), harvest index (HI), and seed number and weight were analyzed across treatments and environments using a combine analysis of variance, where each environment was defined as a combination of location x year x sowing date x variety.

### RESULTS AND DISCUSSION

On average, seed yield was 11% higher in full-N *versus* zero-N treatment across environments ( $P < 0.001$ ; Fig. 1a). However, the yield difference varied from *nil* at low-yield environments (2.5 Mg ha<sup>-1</sup>) to up to 900 kg ha<sup>-1</sup> in high-yield environments (>6 Mg ha<sup>-1</sup>). Indeed, the ANOVA revealed that environment  $\times$  N interaction on seed yield was significant ( $P = 0.025$ ). This finding suggests that N limitation in soybean increases with increasing yield level of the

production environment. The yield differences were attributable to an increased seed number per unit of area and a greater seed weight in the full-N versus zero-N treatment ( $P < 0.001$ ). The full-N treatment also produced (9%) higher ADM ( $P < 0.001$ ) without consistent differences in HI between N treatments ( $P = 0.41$ ). Full-N treatment exhibited (1.3%) higher protein (but not oil) concentration (Fig. 1b).

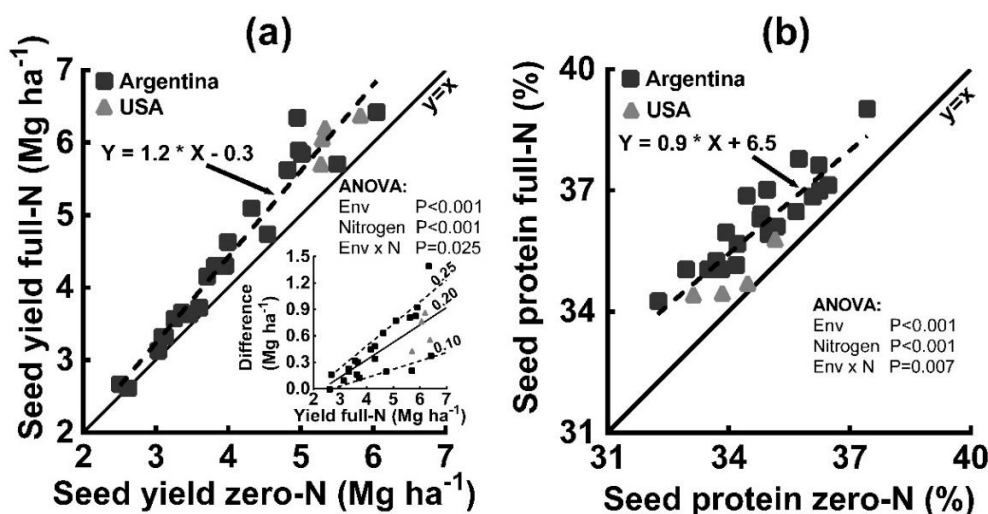

Figure 1. (a) Seed yield in full-N versus zero-N treatments. Each data point represents average yield for a given year x sowing date x variety (Argentina) or producer field (Nebraska, USA). Solid diagonal line indicates  $y = x$ . Inset shows the seed yield difference between the full-N and zero-N treatments relative to the full-N treatment yield. Also shown is the slope of the fitted linear regression (solid line;  $y = 0.2x - 0.46$ ) and the slopes representative of the boundary functions for the 10th and 90th quantiles (dashed lines). (b) Seed protein concentration in full-N versus zero-N treatments. Seed yield and protein concentration values are reported at 13% seed moisture content basis.

The increase in both seed yield and seed protein concentration in the full-N indicates that there is a gap between indigenous N supply (from mineralization and fixation) and crop N requirements in soybean, and that gap becomes larger in accordance with the increasing N demand needed to support higher yields. Our results also suggest that N supply will likely become (if not already) a major yield-limiting factor in high-yield soybean production systems as producer yields in those systems continue to fine-tune their agronomic practices and adopt higher yielding cultivars. This is the already the case of irrigated soybean systems in USA where producer routinely obtained yields  $> 4.5 \text{ Mg ha}^{-1}$ .

## CONCLUSION

The fertilization protocol designed here allowed us to evaluate the degree of N limitation in soybean across a wide range of yield levels. Findings indicate that N limits soybean yield (as well as protein concentration) in high-yield environments where indigenous N sources seem insufficient to fully satisfy crop N requirements. Future research should be directed to increase N fixation and find agronomic practices that 'break' the trade-off between N fertilizer input and N fixation in high-yield environments.

## REFERENCES

- Bender R. R., Haegele J. W., Below F. E., 2015. Nutrient Uptake, Partitioning, and Remobilization in Modern Soybean Varieties. *Agronomy Journal* 107, 563-573.
- Cafaro La Menza N., Monzon J. P., Specht J. E., Grassini P., 2017. Is soybean yield limited by nitrogen supply? *Field Crops Research* 213, 204-212.
- Salvagiotti F., Cassman K. G., Specht J. E., Walters D. T., Weiss A., Dobermann A., 2008. Nitrogen uptake, fixation and response to fertilizer N in soybeans: A review. *Field Crops Research* 108, 1-13.

## **SIMULATION OF LONG TERM C& N DYNAMICS IN A NORTHERN AGRO-ECOSYSTEM WITH DNDC**

JÉGO, G.<sup>1</sup>, CRÉPEAU, M.<sup>1</sup>, CHANTIGNY, M.<sup>1</sup>, D'AMOURS, E.<sup>1</sup>, SMITH, W.<sup>2</sup>, GRANT, B.<sup>2</sup>, LAFOND, J.<sup>1</sup>, ANGERS, D.<sup>1</sup>

<sup>1</sup> Agriculture and Agri-Food Canada (AAFC), Quebec Research Centre, Canada; <sup>2</sup> AAFC, Ottawa Research Centre, Canada

### **INTRODUCTION**

Tillage, fertilizer and cropping systems can affect the nutrient dynamics in crops and soils. For example, following long-term (21 years) liquid dairy manure application, a higher accumulation of soil organic carbon (SOC) stocks was observed in a spring barley - perennial forage (red clover – timothy) rotation than in a spring barley monoculture (Maillard et al., 2016). Yang et al. (2016) observed a higher increase of soil C and N content after 7 years of organic manure amendments compared to mineral fertilization in crop rotation of maize-soybeans. However, under northern climate conditions, reduced tillage or no-till management had insignificant impacts on SOC stocks (Angers et al. 1997). Most of these previous studies focused on C or N cycles of the cropping systems, but rarely both. Monitoring of the complete C and N cycling under long-term experiments can be expensive. Process-based models offer a cost-effective way to supplement field studies. However, the performance of these models needs to be verified with experimental data. Dutta et al., 2017 evaluated the ability of the Canadian DNDC version (DNDCv.Can) and DayCent models to simulate the long term N dynamics in mineral fertilized spring wheat systems in Saskatchewan, but the ability of process-based models, such as DNDC, to simulate the long term effect of organic fertilization on C and N fluxes and balances in crop rotations including perennials was never evaluated under the cold continental humid climate of Eastern Canada.

The objectives of this work were to: (1) evaluate the ability of the DNDCv.Can model to simulate the C and N exported in harvested crops over 21 years of a barley monoculture or a perennial grass – barley rotation fertilized with either mineral, or organic fertilization, and tilled with either a conventional moldboard plow or a chisel plow under conditions in eastern Canada and (2) evaluate the models ability to reproduce the differences in SOC and total soil nitrogen (TSN) between treatments at the end of the 21 years experiment.

### **MATERIAL AND METHODS**

The long-term study site was located at the Normandin Research Farm of Agriculture and Agri-Food Canada (48°50'42''N, 72°32'25''W), in Québec, Canada. The soil and site characteristics as well as crop management were described in detail in Maillard et al. (2016). In summary, the silty clay soil had a concentration of 490 g kg<sup>-1</sup> clay and 80 g kg<sup>-1</sup> sand with a pH-water of 5.6, an initial SOC content of 2.6%, a field capacity of 0.83 wfps (water filled pore space), a wilting point of 0.59 wfps, a hydro-conductivity of 0.015 cm min<sup>-1</sup> and a porosity of 48.7%. The region has a cold continental humid climate with mean annual temperature and precipitation of 1.1°C and 849mm, respectively. Field management consisted of either a spring barley monoculture (M), or a 3-year cereal-grass rotation (R) (one year of spring barley under-seeded with a forage mixture of timothy - red clover and two years of the forage mixture production). A combination of two fertilizations and two tillage management practices were studied (table 1). Experimental trials were performed for 21 years from 1990 to 2010. Yield and C and N content of harvested crops were measured each year. Soils samples at different depths (0 to 50 cm) were taken in 2010 to measure the SOC and TSN stocks.

The DeNitrification-DeComposition model (DNDC) is a process-based model that describes in detail the biochemical cycle of C and N in the agroecosystems. It can predict crop growth, N fixation, SOC, soil organic and inorganic N dynamics, N runoff and leaching as well as the flux of CO<sub>2</sub>, CH<sub>4</sub>, N<sub>2</sub>O, NO and NH<sub>3</sub> from the crop-soil system (Giltrap et al., 2010). The Canadian version of DNDC (DNDCv.CAN) was developed to simulate the biogeochemical cycling under cold weather conditions (Dutta et al., 2016). Daily climatic data used for the simulations (maximum and minimum temperature, precipitation, wind speed, solar radiation and humidity) were



measured at a nearby weather station (Bagotville, QC [48°20' N, 71°00' O]). Simulations were run from 1990 to 2010. Model performance was evaluated by comparing measured and simulated C and N exported in harvests and measured and simulated difference of SOC (0-20 cm and 0-50 cm) and TSN (0-50 cm) in 2010 relative to the M-MP-MIN treatment (table 1).

Table 1. Field experiments and treatments used for calibration and validation of the model.

Grass mixture – barley rotation (R)				Barley monoculture (M)			
Moldboard (MP)		Chisel (CP)		Moldboard (MP)		Chisel (CP)	
MIN <sup>a</sup>	LDM <sup>b</sup>	MIN <sup>a</sup>	LDM <sup>b</sup>	MIN <sup>a</sup>	LDM <sup>b</sup>	MIN <sup>a</sup>	LDM <sup>b</sup>
R-MP-MIN	R-MP-LDM	R-CP-MIN	R-CP-LDM	M-MP-MIN	M-MP-LDM	M-CP-MIN	M-CP-LDM
Validation	Validation	Not simulated	Not simulated	Calibration	Validation	Validation	Validation

<sup>a</sup> mineral fertilization / <sup>b</sup> liquid dairy manure fertilization

## RESULTS AND DISCUSSION

After calibration of the potential crop growth parameters, model performance in simulating C and N exported in harvest was generally good for the validation treatments. The N exports were better simulated than the C exports with normalized root mean square errors (NRMSE) of 16.7% and 22.8% for N and C, respectively. The bias was small for the two variables with normalized mean errors (NME) below 2% in both cases. On average the model tended to slightly overestimate crop yields and C and N exports of the treatments fertilized with mineral N and to slightly underestimate the yield of the LDM treatments. However, while the model was able to reproduce fairly well the difference of SOC over the 0-20 cm layer, except for the R-MP-MIN treatment (NRMSE = 40% and EF = 0.82 without this treatment), it generally failed in predicting the difference between treatments over the 0-50 cm layer (NRMSE ≥ 70% and EF < 0). The model was generally able to capture the greater SOC and TSN accumulation in the forage rotation than in the monoculture and in the LDM treatment than with MIN fertilizer, but it failed in simulating the impact of tillage, with a systematic underestimation of SOC accumulation under MP treatments. Simulation of the complete C and N balances shows that reactive N losses were small for all treatments (< 20 kg N ha<sup>-1</sup>). Treatments fertilized with LDM tended to have greater simulated N losses than mineral N treatments because of greater ammonia emissions. Simulated nitrate leaching was, however, generally higher in mineral N treatments than in treatments fertilized with LDM.

These results confirm that more effort should be put in better understanding and simulating the C and N dynamics in deeper soil layers. Model improvements, such as a better description of SOC profile at model initialization, which is currently under development in DNDC, could represent a good step forward in better simulating these dynamics in deep soil layers.

## REFERENCES

- Angers D.A., Bolinder M.A., Carter M.R., Gregorich E.G., Drury C.F., Liang B.C., Voroney R.P., Simard R.R., Donald R.G., Beyaert R.P., Martel J., 1997. Impact of tillage practices on organic carbon and nitrogen storage in cool, humid soils of eastern Canada. *Soil and Tillage Research* 41(3): 191-201.
- Giltrap D. L., Li C., Saggat S., 2010. DNDC: A process-based model of greenhouse gas fluxes from agricultural soils. *Agriculture, Ecosystems & Environment*, 136(3-4), 292-300.
- Maillard É., Angers D.A., Chantigny M., Lafond J., Pageau D., Rochette P., Lévesque G., Leclerc M.-L., Parent L.-É., 2016. Greater accumulation of soil organic carbon after liquid dairy manure application under cereal-forage rotation than cereal monoculture. *Agriculture, Ecosystems & Environment* 233: 171-178.
- Yang R., Su Y.-Z., Wang T., Yang Q., 2016. Effect of chemical and organic fertilization on soil carbon and nitrogen accumulation in a newly cultivated farmland. *Journal of Integrative Agriculture*, 15(3), 658-666.
- Dutta B., Congreves K.A., Smith W.N., Grant B.B., Rochette P., Chantigny M.H., Desjardins R.L., 2016. Improving DNDC model to estimate ammonia loss from urea fertilizer application in temperate agroecosystems. *Nutr. Cycl. Agroecosyst.* 106(3): 275-292.

## DIMETHYL PYRAZOL-BASED NITRIFICATION INHIBITORS EFFECT ON N CYCLE BACTERIA RESPONSIBLE OF N<sub>2</sub>O EMISSIONS IN GRASSLAND

FUERTE-MENDIZABAL, T., HUERFANO, X., TORRALBO, F., VEGA-MAS, I., MENENDEZ, S., GONZALEZ-MURUA, C., ESTAVILLO, J.M.

University of the Basque Country UPV/EHU, Dept. Plant Biology and Ecology, Apd. 644, Bilbao, Bizkaia 48080, Spain

### INTRODUCTION

Intensive N fertilization of agricultural soils is by far the main anthropogenic source of N<sub>2</sub>O emissions. Soil N<sub>2</sub>O emissions are mainly the result of the biological processes of nitrification and denitrification. Although both processes occur simultaneously under most soil conditions, being the net flux to the atmosphere the result of both processes together, nitrification is the preferential source of N<sub>2</sub>O under more aerated soils (water filled pore space WFPS < 60%) and denitrification is the dominant process in soils with WFPS of ≥ 70% (Bateman and Baggs, 2005). Among the strategies to mitigate N losses from agriculture the Intergovernmental Panel on Climate Change (IPCC) has proposed the application of ammonium-based fertilizers combined with nitrification inhibitors (NI). NIs reduce nitrification rates (blocking ammonia monooxygenase enzyme, AMO) and subsequent denitrification rates due to reduction of NO<sub>3</sub><sup>-</sup> availability. Recent studies under laboratory conditions (Barrena et al., 2017, Torralbo et al., 2017) showed an effect of dimethyl pyrazole-based NIs also stimulating the last step of the denitrification process that consists of the reduction of N<sub>2</sub>O to N<sub>2</sub>, increasing nosZ gene abundance under high WFPS conditions. However, the effect of NIs decreasing N<sub>2</sub>O emissions depends on many environmental factors such as pH, temperature and soil water content. The objective of this study was to compare the effect of 3,4-dimethylpyrazole succinic acid (DMPSA) with respect to 3,4-dimethylpyrazole phosphate (DMPP) on soil bacterial populations responsible of N<sub>2</sub>O emissions in a grassland under Atlantic climate conditions.

### MATERIALS AND METHODS

The work was conducted in a grassland at the Basque Country sown with ryegrass (*Lolium multiflorum* Lam. var Westerwold starter) in autumn 2016. A randomized complete block design with four replicates was established with an individual plot size of 28 m<sup>2</sup>. Four treatments were applied: an unfertilized control, ammonium sulphate (AS) and two treatments consisting in the combination of AS with the DMPSA and with DMPP, respectively. The N rate applied was of 80 kg N ha<sup>-1</sup> at 27<sup>th</sup> January and 60 kg N ha<sup>-1</sup> at 29<sup>th</sup> March. Soil samples were collected 15, 30 and 60 days after each fertilization event to quantify bacterial populations. Quantification of bacteria abundances (16S rRNA) and functional marker genes involved on nitrification (*amoA*) and denitrification (*nosZI*) were amplified by qPCR. Standard curves were prepared from serial dilutions of linearized plasmids with insertions of the target genes according to Torralbo et al. (2017). After test normality and homogeneity of variances, significant differences were analysed using one-way ANOVA with a Duncan post hoc test.

### RESULTS AND DISCUSSION

After the application of the first fertilizer amendment, winter rainfall allowed to maintain WFPS at values ≥60%. After the second amendment, values of soil WFPS were ≤60%. Whatever the soil WFPS, both DMPP and DMPSA avoided the ammonia oxidizer bacteria stimulation associated to AS amendment (Fig. 1), without disturbing bacteria abundance measured by means of 16S rRNA gene abundance (data not shown). Interestingly, both NIs induced a rise of N<sub>2</sub>O-reducing bacteria at the end of the first period, 60 days after the application of 80 kg N ha<sup>-1</sup> of AS combined with NIs. This suggests that after certain period of time under conditions of WFPS favouring the denitrification process, both NIs can promote the denitrification process up to N<sub>2</sub>.

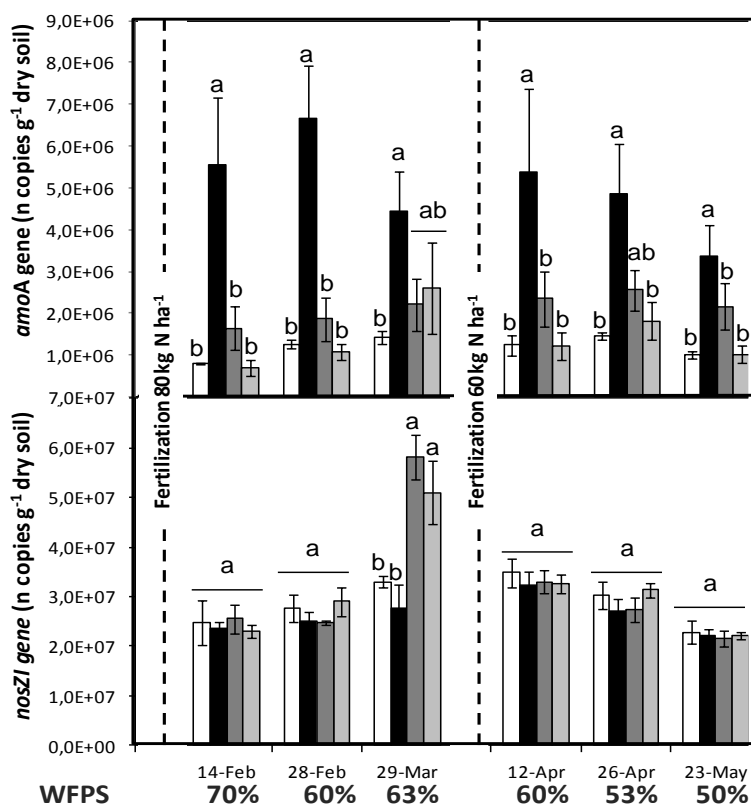

Figure 1. Abundance of *amoA* (top) and *nosZ* (bottom) genes expressed as gene copy number per gram of dry soil at 15, 30 and 60 days after fertilizations. Below each date values of WFPS are shown. Values represent the mean  $\pm$  SE ( $n = 4$ ). White bars = unfertilized control; black bars = AS, dark grey bars = AS+DMPP and light grey bars = AS+DMPSA. Treatments sharing the same letter within each day do not differ significantly at  $p \leq 0.05$ .

## CONCLUSION

Our data demonstrate under field conditions that DMPP and DMPSA have the potential to diminish  $N_2O$  emissions playing a dual role: inhibiting the nitrification process due to a decrease in ammonia oxidizer bacterial population whatever the soil WFPS values, and also increasing *nosZ* abundance and therefore potentially stimulating the denitrification process up to  $N_2$  under high soil water content conditions.

**Acknowledgements:** Spanish Government (AGL2015-64582-C3-2-R MINECO/FEDER), by the Basque Government (IT-932-16) and by EuroChem Agro Iberia S.L.-UPV/EHU 2015.0248 and 2016.0339.

## REFERENCES

- Bateman, E.J., Baggs, E.M., 2005. Contributions of nitrification and denitrification to  $N_2O$  emissions from soils at different water-filled pore space. *Biology and Fertility of Soils*, 41, 379-388.
- Barrena, I., Menéndez, S., Correa-Galeote, D., Vega-Mas, I., Bedmar, E.J., González-Murua, C., Estavillo, J.M., 2017. Soil water content modulates the effect of the nitrification inhibitor 3,4-dimethylpyrazole phosphate (DMPP) on nitrifying and denitrifying bacteria. *Geoderma* 303: 1-8.
- Torralbo, F., Menéndez, S., Barrena, I., Estavillo, J.M., Marino, D., González-Murua, C., 2017. Dimethyl pyrazole-based nitrification inhibitors effect on nitrifying and denitrifying bacteria to mitigate  $N_2O$  emission. *Scientific Reports*, 7: 13810.

### **3,4-DIMETHYLPYRAZOLE-SUCCINIC ACID (DMPSA) NITRIFICATION INHIBITOR EFFECTIVELY REDUCES N<sub>2</sub>O EMISSIONS IN A WINTER WHEAT CROP UNDER NO-TILLAGE MANAGEMENT**

CORROCHANO-MONSALVE, M., HUÉRFANO, X., FUERTES-MENDIZABAL, T., ESTAVILLO, J.M., GONZÁLEZ-MURUA, C.

University of the Basque Country UPV/EHU, Dept. Plant Biology and Ecology, Apd. 644, Bilbao, Bizkaia 48080, Spain

#### **INTRODUCTION**

Conventional tillage (CT) managed soils are vulnerable to nitrate leaching losses and water evaporation. No-tillage (NT) management is a way not only to retain water and nutrients in the soil surface layers but also to reduce fuel cost and fuel associated CO<sub>2</sub> greenhouse gas (GHG) emissions. Apart from the nitrate lost by leaching, the N applied with fertilizers can also be lost as the GHG nitrous oxide (N<sub>2</sub>O) by means of the bacterial processes of nitrification and denitrification. Nitrification inhibitors have been developed in order to slow down the nitrification processes and consequently increase the N use efficiency. In this work, we evaluate in a winter wheat crop the effect of two different land managements (CT and NT) and the use of the NI 3,4-dimethylpyrazole-succinic acid (DMPSA) in N<sub>2</sub>O emissions.

#### **MATERIALS AND METHODS**

The work was conducted in a winter wheat (*Triticum aestivum* L., var. Cezanne) crop in Arkaute, northern Spain. To compare CT and NT managements two randomized complete blocks designs were established with four replicates and an individual plot size of 40m<sup>2</sup>. Seedbed preparation consisted in mechanical tillage (disk and moldboard plow) for CT and direct sowing for NT. Wheat was sown at density of 220 kg seeds ha<sup>-1</sup> and previous crop was also winter wheat. Within each design, three treatments were applied: a control unfertilized treatment, a second treatment fertilized with ammonium sulphate 21% (AS) and a third one consisting of AS 21% combined with DMPSA (AS+DMPSA). Fertilization rate was 180 kg N ha<sup>-1</sup> applied either in a single application at beginning of tillering stage (GS21) or split in two applications of 60 kg N ha<sup>-1</sup> at beginning of tillering stage (GS21) and 120 kg N ha<sup>-1</sup> at stem elongation stage (GS30). N<sub>2</sub>O emissions were measured using the close chamber method (Chadwick et al., 2014). Air samples were analyzed by gas chromatography (Agilent, 7890A) equipped with an electron capture detector for N<sub>2</sub>O detection. Data were analysed using the IBM SPSS statistics 24 software (Armonk, NY, USA). Analysis of significant differences in N<sub>2</sub>O cumulative emissions were carried out using one-way ANOVA with a Duncan post hoc test and T-student tests between AS and AS+DMPSA treatments. Significant differences were conducted at  $p < 0.05$ .

#### **RESULTS AND DISCUSSION**

After first fertilization, the effect of AS application on N<sub>2</sub>O emissions was clearer in NT than in CT probably due to the higher soil water filled pore space (WFPS) values, which were above 60% in NT (Fig. 1). These higher WFPS conditions enable not only nitrification to occur but also denitrification, thus increasing N<sub>2</sub>O emissions (del Prado et al., 2006). After second fertilization, however, WFPS was below 60% in both managements (Fig. 1), which provided similar conditions for nitrification to occur in both CT and NT. Under these similar WFPS conditions, the control treatment showed that the tillage management induced a great increase in N<sub>2</sub>O emissions, while higher emissions after the second fertilization than in the first were attributable to the warmer spring conditions. In CT, this higher basal emission rate induced by tillage masked the fertilizer effect on N<sub>2</sub>O emissions, and so the effect of DMPSA reducing these emissions. On the other hand, the effect of DMPSA was clearly observed under NT conditions, being able to reduce N<sub>2</sub>O emissions up to the unfertilized control levels (Table 1).

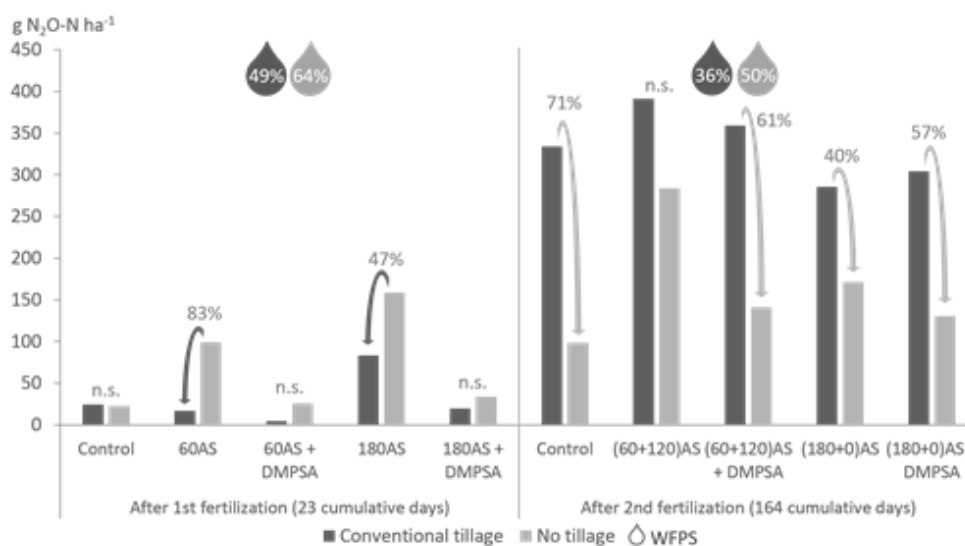

Figure 1. N<sub>2</sub>O emissions by management (Conventional tillage, black; No tillage, grey) and by periods (after 1<sup>st</sup> fertilization, and after 2<sup>nd</sup> fertilization). Days in brackets represent the period length. Arrows show significant differences between managements in each treatment, with percentage change above. Values in drops represent average WFPS value for each period and each management.

Table 1. Cumulative N<sub>2</sub>O emissions, from day 1 to day 187 and under single (180+0) or split (60+120) fertilization. Values in brackets are the percentage of decrease of each NI with respect to AS and statistical significance. Different letters within a column indicate significant differences ( $P < 0.05$ ;  $n = 4$ ).

		g N <sub>2</sub> O-N ha <sup>-1</sup>	
Fertilizer dose (kg N ha <sup>-1</sup> )	Treatment	Conventional tillage	No tillage
180+0	Control	358,36 a	121,15 b
	AS	368,79 a	330,45 a
	AS + DMPSA	324,12 a (-12%) (n.s.)	164,2 b (-50%) (0.001)
60+120	Control	358,36 A	121,15 B
	AS	408,63 A	383,31 A
	AS + DMPSA	363,86 A (-11%) (n.s.)	166,72 B (-65%) (0.003)

## CONCLUSION

Under humid Mediterranean conditions, the tillage management induces an increase in N<sub>2</sub>O emissions, which masks the fertilizer and DMPSA effects on them. Under no-tillage conditions, where N<sub>2</sub>O shows a clear response to fertilization, DMPSA significantly reduce these emissions up to the unfertilized control level in both single and split fertilizations.

**Acknowledgements:** This project was funded by the Spanish Government (AGL2015-64582-C3-2-R MINECO/FEDER), by the Basque Government (IT-932-16) and by EuroChem Agro Iberia S.L.-UPV/EHU (2015.0033).

## REFERENCES

- del Prado, A., Merino, P., Estavillo, J.M., Pinto, M., González-Murua, C., 2006. N range of soil water contents. *Nutr. Cycling Agroecosyst.* 74, 229–243.
- Chadwick, D.R., Cardenas, L., Misselbrook, T.H., Smith, K.A., Rees, R.-M., Watson, C.J., McGeough, K.L., Williams, J.R., Cloy, J.M., Thorman, R.E., Dhanoa, M.S., 2014. Optimizing chamber methods for measuring nitrous oxide emissions from plot-based agricultural experiments. *Eur. J. Soil Sci.* 65 (2), 295–307.

## EFFECT OF N FERTILIZATION RATE AND SOIL TILLAGE ON N<sub>2</sub>O EMISSIONS FROM IRRIGATED CORN IN A MEDITERRANEAN AGROECOSYSTEM

PAREJA-SÁNCHEZ, E.<sup>1</sup>, PLAZA-BONILLA, D.<sup>2</sup>, ÁLVARO-FUENTES, J.<sup>2</sup>, CANTERO-MARTÍNEZ C.<sup>1</sup>

<sup>1</sup> Departamento de Producción Vegetal y Ciencia Forestal, Unidad Asociada CSIC, Agrotecnio. Universidad de Lleida, 25198 Lleida, Spain; <sup>2</sup> Departamento de Suelo y Agua. Estación Experimental de Aula Dei (EEAD-CSIC), 50056 Zaragoza, Spain.

### INTRODUCTION

Most of the nitrous oxide (N<sub>2</sub>O) emissions take place in soils and are related with agricultural activities. An adequate choice of agricultural management practices such as nitrogen (N) fertilization or tillage can help to reduce the emission of N<sub>2</sub>O from soils, mitigating global warming, without necessarily reducing crop yields. The aim of this work was to quantify the emission of N<sub>2</sub>O from soils and its relationship with corn yields according to different soil management practices and synthetic N fertilization rates and to analyze the impact of environmental variables on the emissions in a Mediterranean semiarid area recently transformed to irrigation.

### MATERIAL AND METHODS

The study was carried out in NE Spain (mean annual precipitation and potential evapotranspiration: 430 and 855 mm, respectively), in a long-term tillage and N rate experiment (established in 1996), which was transformed into irrigation by installing a fixed sprinkler system with corn (*Zea mays* L.) as cropping system in 2015. Previously, the cropping system consisted of a rainfed barley monoculture (1996-2014 period). Three types of tillage (no-tillage, NT; reduced tillage, RT; and conventional intensive tillage, CT) and three mineral N fertilization rates (0, 200, 400 kg N ha<sup>-1</sup>) were compared. In the NT treatment, non-selective herbicides were applied for weed control. The RT treatment consisted of one pass of a strip-till implement on the sowing line to 30 cm depth. Finally, the CT treatment consisted of one pass of a rototiller to 15 cm depth followed by a subsoiler to 35 cm depth and finished by one pass of a disc plough to 20 cm depth, according to the traditional practice for corn cultivation in the area. Nitrogen fertilizer applications were split into one pre-sowing as urea and two top-dressing applications at V5 and V10 as ammonium nitrate. The experiment was laid out in a randomized block design with three replications. During two corn growing seasons (from April to November 2015 and 2016) and the two short fallow periods between growing seasons, weekly soil N<sub>2</sub>O emissions were measured, being more intense during fertilizer applications (i.e. 24 h. prior and 3 h. and 48h. after) using non-steady state static chambers (Hutchinson and Mosier, 1981). Gas samples were analyzed by a gas chromatography system equipped with an ECD detector. On each sampling date and close to each chamber, soil temperature and volumetric water content of the 0-5 cm depth were also quantified. The water-filled pore space (WFPS) was calculated with soil bulk density, which was quantified monthly. Corn yield was quantified at harvest to estimate yield-scaled N<sub>2</sub>O emissions, expressed as kg of CO<sub>2</sub> equivalents emitted per kg of grain produced. For each year, the emission factor (EF) was also quantified.

### RESULTS AND DISCUSSION

Soil N<sub>2</sub>O emissions were significantly affected by tillage, N fertilization rate, sampling date and their interactions. The application of 400 kg N ha<sup>-1</sup> led to greater soil N<sub>2</sub>O emissions in NT, followed by RT and CT (0.50, 0.31 and 0.23 mg N<sub>2</sub>O-N m<sup>-2</sup>d<sup>-1</sup>, respectively as an average of the different sampling dates covered by the experiment). The use of 200 kg N ha<sup>-1</sup> led to similar N<sub>2</sub>O emissions in RT (0.16 mg N<sub>2</sub>O-N m<sup>-2</sup>d<sup>-1</sup>) and CT (0.03 mg N<sub>2</sub>O-N m<sup>-2</sup>d<sup>-1</sup>), and showed greater values under NT (0.28 mg N<sub>2</sub>O-N m<sup>-2</sup>d<sup>-1</sup>). In 2015, the interaction between tillage and N fertilization rates significantly affected cumulative soil N<sub>2</sub>O emissions, with lowest values at the rates of 200 and 400 kg N ha<sup>-1</sup> under CT. The highest N rate increased soil N<sub>2</sub>O emissions especially just after the application of fertilizer, independently of the tillage system. However, cumulative soil N<sub>2</sub>O emissions in 2016 were only affected by N fertilization, with greatest values at rates of 200 and 400 kg N ha<sup>-1</sup>. The WFPS was significantly affected by tillage and N fertilization treatments, decreasing in the order NT > RT > CT for tillage and 400 > 200 > 0 kg N ha<sup>-1</sup> for N fertilization, in both years. No-tillage presented greater WFPS than CT at most sampling dates, with mean values

60.1 and 35.8 % for NT and CT, respectively. In 2015, grain yield was significantly affected by tillage and N fertilization, with greater grain yield under NT and RT (11406 and 9547 kg ha<sup>-1</sup>, respectively) compared with CT (5594 kg ha<sup>-1</sup>) and under the rates of 200 and 400 kg N ha<sup>-1</sup> (10394 and 8447 kg ha<sup>-1</sup>) compared to the control without N (7705 kg ha<sup>-1</sup>). However, grain yield was significantly affected by the interaction between tillage and N fertilization in 2016. Differences between tillage systems were only observed when applying 400 kg N ha<sup>-1</sup>, with greater grain yields in NT and RT than in CT (12242, 8839 and 4260 kg ha<sup>-1</sup> respectively). The lower values of WFPS and reduction in grain yield for CT are a consequence of the lower soil structural stability under long-term CT, which would have reduced water infiltration due to soil crusting (Pareja-Sánchez et al., 2017). Therefore, soil degradation as a result of long-term use of intensive tillage caused a severe water stress to corn, with a negative influence on grain yields. Nitrogen rates significantly affected N<sub>2</sub>O yield-scaled emissions in 2015, with values increasing with the N fertilizer rate: 0.002, 0.011 and 0.035 kg CO<sub>2</sub> equiv. kg grain<sup>-1</sup> for the 0, 200 and 400 kg N ha<sup>-1</sup> treatments, respectively, with no differences between treatments in 2016. In 2015, the greatest EF was observed when applying 400 kg N ha<sup>-1</sup> under NT. In 2016 the EF increased in all treatments, with highest values for NT and CT (Table 1).

*Table 1. Soil N<sub>2</sub>O emission factor (EF) in 2015 and 2016 as affected by N fertilization rate (200 and 400 kg N ha<sup>-1</sup>) and tillage system (NT, no-tillage; RT, reduced tillage; CT, conventional intensive tillage).*

Year	Tillage treatment	EF (%)	
		200 kg N ha <sup>-1</sup>	400 kg N ha <sup>-1</sup>
2015	NT	0.16	0.22
	RT	0.07	0.14
	CT	0.09	0.09
2016	NT	0.22	0.21
	RT	0.12	0.12
	CT	0.33	0.21

## CONCLUSION

In the Mediterranean irrigated corn system studied, NT led to higher emissions of N<sub>2</sub>O from soils to the atmosphere than RT and CT. An increase in the fertilizer N application rate increased N<sub>2</sub>O emissions, especially just after the application of N fertilizer. However, NT and RT increased the grain production compared to CT due to severe soil crusting causing water deficit. Nitrogen fertilizer treatments significantly affected the yield-scaled N<sub>2</sub>O emissions in 2015, increasing with increasing fertilizer N application rate. Independently of the treatment, the EF was much lower than the 1% factor currently proposed by the IPCC. The results presented highlight that N fertilization and tillage play an important role on N<sub>2</sub>O emissions and on corn production in irrigated Mediterranean agroecosystems prone to soil degradation.

**Acknowledgements:** This research work is financially supported by the Spanish Ministry of Education and Science (project AGL2013-49062-C4-1-R and grant BES-2014-070039).

## REFERENCES

- Hutchinson G.L., Mosier A.R., 1981. Improved soil cover method for field measurement of nitrous oxide fluxes. *Soil Sci. Soc. Am. J.*, 45, 311–316.
- Pareja-Sánchez E., Plaza-Bonilla D., Ramos M.C., Lampurlanés J., Álvaro-Fuentes J., Cantero-Martínez C., 2017. Long term no-till as a means to maintain soil surface structure in an agroecosystem transformed into irrigation. *Soil Tillage Res.* 174, 221–230.

## EVALUATION OF THE SENSITIVITY OF PORTABLE CHLOROPHYLL METERS TO ESTIMATE LEAF CHLOROPHYLL AND N CONTENTS UNDER EXCESSIVE N CONDITIONS

PADILLA, F.M.<sup>1</sup>, PEÑA-FLEITAS, M.T.<sup>1</sup>, DE SOUZA, R.<sup>1</sup>, GIMÉNEZ, C.<sup>2</sup>, THOMPSON, R.B.<sup>1</sup>, GALLARDO, M.<sup>1</sup>

<sup>1</sup>University of Almeria, Almeria, Spain; <sup>2</sup>University of Cordoba, Cordoba, Spain

### INTRODUCTION

Chlorophyll meters (CMs) are a promising approach for monitoring crop nitrogen (N) status of intensively-produced vegetable crops. To do so effectively, it is fundamental that the nature and strength of the relationships between CMs measurements and actual chlorophyll and nitrogen contents be evaluated. Particularly, little is known about these relationships when expanding the range to excessive N conditions. Given that excessive N application is a common occurrence in intensive vegetable crops, the ability of CMs to retain sensitivity under excessive crop N status is an important practical consideration. The objectives of this work were to evaluate the sensitivity of different CMs to estimate leaf chlorophyll and N contents under excessive N conditions.

### MATERIAL AND METHODS

The SPAD-502 meter (Konica Minolta, Inc., Tokyo, Japan), the atLEAF+ sensor (FT Green LLC, Wilmington, DE, USA), the MC-100 Chlorophyll Concentration Meter (Apogee Instruments, Inc., Logan UT, USA), and the Multiplex 3.6 sensor (Force-A, Orsay, France), were evaluated in a sweet pepper (*Capsicum annuum* 'Melchor') crop in Almeria, southeastern Spain. There were five N treatments of different N concentrations (very deficient, deficient, optimal, excessive and very excessive) in nutrient solutions applied by fertigation.

CMs measurements commenced on 15 September 2016 and were repeated every two weeks, on average, until 12 December 2016, for a total of six measurement dates. Measurements were always made at the same time each day (07:00 to 09:00 solar time). Individual CM measurements with each sensor were made on 6 different marked plants in each of four replicated plots of the five N treatments. One measurement per plant was made on a fully expanded and well-lit leaf, on the distal part of the adaxial (top) side of the leaf, midway between the margin and the mid-rib of the leaf. The same leaf and spot was measured with the four CMs.

Immediately after CMs measurements, each leaf was excised and a leaf disk (5.6 mm diameter) was taken in the center of the measuring spot using a metal ring, after which the leaf disk was sealed in a zip plastic bag and frozen. Chlorophyll was extracted with 80% aqueous acetone solvent; the concentration of chlorophyll *a+b* was calculated using the equations described by Porra et al. (1989) from absorbance at 646.5 nm and 663.5 nm. The rest of the sampled leaf was enclosed in paper bag and oven dried at 65°C until constant weight. The leaf N content (%) was determined using a Dumas-type elemental analyzer system.

Data collected on the six dates of measurement were pooled and regression analyses were conducted to evaluate the nature and the strength of the relationships between: 1) chlorophyll content and CMs measurements, 2) leaf N content and chlorophyll content, and 3) leaf N content and CMs measurements. Linear, quadratic, power, exponential and natural logarithmic regressions were considered, and the best was selected using the Akaike Information Criterion. The CurveExpert Professional® 2.6.0 software was used.

### RESULTS AND DISCUSSION

Chlorophyll content was positively and strongly related to all CMs measurements with curvilinear-like relationships (Figure 1). The relationships were quadratic for SPAD units, atLEAF units, and the Simple Fluorescence Ratio (SFR\_R) index measured with the Multiplex sensor; a power relationship was found for the Chlorophyll Content Index (CCI) measured with the MC-100 Chlorophyll Concentration Meter. There was a



tendency of saturation or a plateau of SPAD, atLEAF and SFR\_ values at higher chlorophyll content; notably, there was no indication of saturation of CCI values over the entire range of chlorophyll measured (Figure 1).

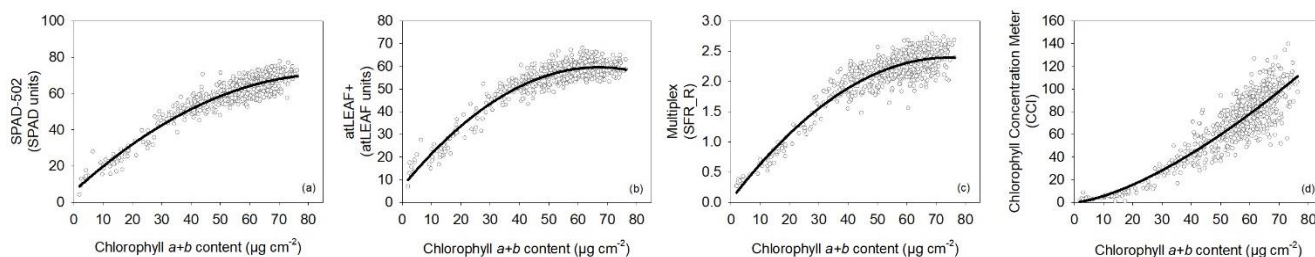

Figure 1. Relationships between chlorophyll and different CM measurements. SFR\_R is Simple Fluorescence Ratio under red excitation, and CCI is Chlorophyll Content Index.

The CCI estimated with most accuracy, in terms of higher coefficient of determination, chlorophyll content, followed by the SPAD-502 meter and the SFR\_R index (Table 1). Measurements of the atLEAF+ sensor estimated with slightly less precision chlorophyll content.

Table 1. Equations to estimate chlorophyll content ( $\mu\text{g cm}^{-2}$ ) from measurements with different CMs. SFR\_R is Simple Fluorescence Ratio under red excitation, and CCI is Chlorophyll Content Index.

Chlorophyll meter	Equation
SPAD-502	$\text{Chl} = -9.87 + 0.99 \times \text{SPAD} + 0.002 \times \text{SPAD}^2$
atLEAF+	$\text{Chl} = 0.08 \times \text{atLEAF}^{1.63}$
MC-100	$\text{Chl} = 7.95 + 1.03 \times \text{CCI} - 0.005 \times \text{CCI}^2$
Multiplex	$\text{Chl} = -8.36 + 29.35 \times \text{SFR}_R$

## CONCLUSION

Overall, the strong relationships obtained between all four CMs and chlorophyll content confirm that these CMs can be used as non-destructive indicators of leaf chlorophyll content in sweet pepper. However, under excessive N conditions, it is suitable the use of CMs that do not exhibit a plateau response to high leaf chlorophyll and N contents. The MC-100 Chlorophyll Concentration Meter would have an advantage over the rest of CMs evaluated in this study. For non-saturating leaf chlorophyll and N contents, all four CMs evaluated are of value, but the MC-100 Chlorophyll Concentration Index and the SPAD-502 meters provided the most accurate estimation of leaf chlorophyll content. On-going analysis of leaf N content will complement the evaluation of CMs to estimate leaf N content under excessive N conditions.

**Acknowledgements:** The Spanish Ministry of Economy and Competitiveness funded this work (Project AGL2015-67076-R). FMP was supported by a Ramón y Cajal grant (RYC-2014-15815).

## REFERENCES

Porra, R.J., Thompson, W.A. and Kriedemann, P.E., 1989. Determination of accurate extinction coefficients and simultaneous equations for assaying chlorophylls a and b extracted with four different solvents: verification of the concentration of chlorophyll standards by atomic absorption spectroscopy. *BBA - Bioenergetics*, 975(3): 384-394.

**LEAF NITROGEN AND  $\delta^{15}\text{N}$  FRACTIONATION DURING RESORPTION IN BEECH AND LARCH TREES IN JAPAN**LOPEZ C, M.L.<sup>1</sup>, ENTA, A.<sup>1</sup>, FUJIYOSHI, L.<sup>2</sup> YAMANAKA, T.<sup>3</sup>, OIKAWA, A.<sup>1</sup><sup>1</sup> Faculty of Agriculture, Yamagata University, Japan; <sup>2</sup> RIHN, Kyoto, Japan; <sup>3</sup> Okayama University, Okayama, Japan**INTRODUCTION**

Anthropogenic N available for plants has been increasing due to human activities in recent decades (Yuan et al., 2005) and therefore it is necessary to understand its effects on N dynamics and tree internal pathways. N resorption from senescent leaves to plant storage tissues is one of the most important processes. The N stored in plant tissues becomes in addition to the soil inorganic nitrogen another source of nitrogen with a different  $\delta^{15}\text{N}$  (Kolb and Evans 2002). However, until now, very few studies have used  $\delta^{15}\text{N}$  to examine this process (Kolb and Evans 2002; Templer et al., 2007). Thus, the objectives of this study are to determine if fractionation occurs during leaf N resorption of senescing leaves and to evaluate the effect of protein hydrolysis in N isotope discrimination.

**MATERIAL AND METHODS**

This study was conducted at the Yamagata University Research Forest (38°33' N, 139°51' E). The forest stands are located in the northernmost area of the Asahi Mountains and belong to the cool temperate deciduous broad-leaves zone. In this leaves N concentration and  $\delta^{15}\text{N}$  and were measured in each of the three leaf growth periods (green leaf, pre-abscission and post-abscission periods). From leaf N content values, N Resorption Efficiency (NRE) and N Resorption Proficiency (NRP) were calculated.

**Leaf protein and amino acid content**

Leaves from three individuals at each of the two stands were randomly chosen and analyzed for protein and amino acids content in each of the three leaf growth periods (green leaf, pre-abscission and post-abscission).

**RESULTS AND DISCUSSION****Nitrogen content, NRE and NRP**

The decrease of N content in green to pre-abscission and from pre- to post-abscission leaves in beech trees was 19.8% and 48.8% respectively and significant differences were found in both cases, while in larch, the decrease in N content from green to pre- to post-abscission leaves was 17.5% from and 33.4% respectively. A significant difference was found for the second period but not for the first one. NRE and NRP of beech leaves were 68.7% and 14.8 mg g<sup>-1</sup> while that for larch was 50.9% and 8.6 mg g<sup>-1</sup> respectively (Table 1).

Table 1. Nitrogen concentration in green, pre- and post-abscission leaves of beech and larch tree species. Nitrogen resorption efficiency (NRE) and N resorption proficiency (NRP) were calculated from these values.

Tree species	Green leaf	Pre abscission Leaf	Post-abscission Leaf	NRE (%)	NRP (mg g <sup>-1</sup> )
Beech	2.2±0.2	1.7±0.2	0.7±0.0	68.7	14.8
Larch	1.7±0.3	1.4±0.2	0.8±0.0	50.9	8.6

**Leaf  $\delta^{15}\text{N}$  and protein hydrolysis**

Leaf  $\delta^{15}\text{N}$  of green, pre-abscission and post-abscission leaves of beech and larch ranged between -1.5 ‰ to -2.7 ‰ and +0.5 ‰ to -0.9 ‰ respectively. For beech, there was a significant difference (p<0.05) in the  $\delta^{15}\text{N}$  of green and pre-abscission leaves but not in the  $\delta^{15}\text{N}$  of pre- to post-abscission leaves (Fig. 1). Since leaf N resorption occurs simultaneously with protein hydrolysis initially the N reabsorbed is in the form of protein N (Chapin and

Kedrowski, 1983) and as hydrolysis progressed, indicated by the sharp increase in amino acids in pre-abscission leaves, they become the major N fraction driving leaf  $\delta^{15}\text{N}$ . Thus,  $\delta^{15}\text{N}$  fractionation between green and pre-abscission leaves is the withdrawal of isotopically heavier protein N than the lighter amino acids remaining in the leaves. Consequently, the sharp drop of amino acids content from pre- to post-abscission leaves indicates that hydrolysis was almost negligible and amino acids was the N fraction that moved back and remained in the post-abscission leaves. The percentage of larch leaf N reabsorbed was also considerable but it appears that hydrolysis was more active as suggested from the higher amino acids content in larch leaves.

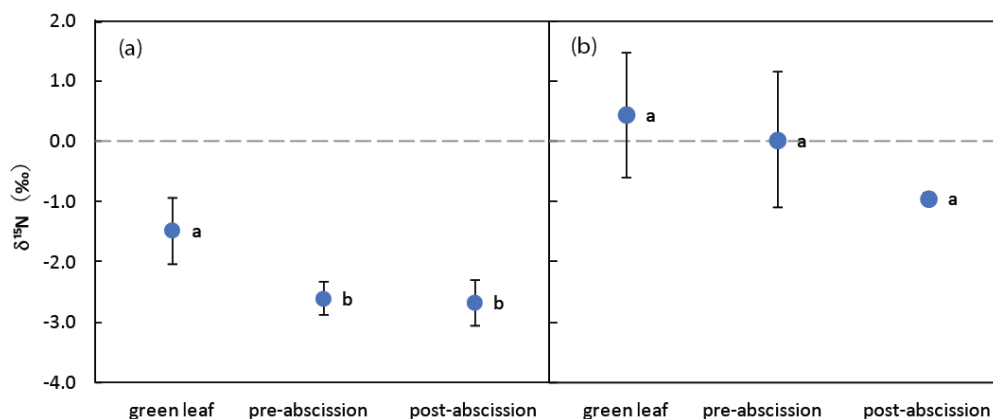

Figure 1. Mean  $\delta^{15}\text{N}$  values in August, October and November of (a) beech and (b) larch leaves.

## CONCLUSION

In this study, N fractionation was found during leaf N resorption in beech trees, but not for larch. Protein hydrolysis in beech leaves was the lower as inferred by the lower content of amino acids found in pre-abscission leaves, suggesting that N withdrawn from leaves was in the form of proteins and thus heavier than the  $\delta^{15}\text{N}$  of the amino acids in the remaining leaves.

**Acknowledgements:** We want to thank the University Forest personnel for their support during the sampling campaigns.

## REFERENCES

- Chapin F.S., Kedrowski R.A., 1983. Seasonal changes in nitrogen and phosphorus fractions and autumn retranslocation in evergreen and deciduous taiga trees. *Ecology* 64, 376–391.
- Chavez-Vergara B.M., Merino A., Vázquez-Marrufo G., García-Oliva F., 2009. Organic matter dynamics and microbial activity during decomposition of forest floor under two native neotropical oak species in a temperate deciduous forest in Mexico. *Geoderma* 235–236, 133-145
- Kolb K.J., Evans R.D., 2002. Implications of leaf nitrogen recycling on the nitrogen isotope composition of deciduous plant tissues. *New phytologist* 156 (1), 57-64
- Templer P.H., Dawson T.E., 2007. Nitrogen uptake by four tree species of the Catskill Mountains, New York: Implications for forest N dynamics, *Plant Soil* 262, 251-261.
- Yuan A.N., Wan S., Zhou X., Subedar A.A., Wallace L.L., Luo Y., 2005. Plant nitrogen concentration, use efficiency, and contents in a tallgrass prairie ecosystem under experimental warming. *Global Change Biology* 11, 1733–1744.

## LINKING BIOCHAR PROPERTIES WITH ITS ABILITY TO PROMOTE N<sub>2</sub>O REDUCTION TO N<sub>2</sub> IN AGRICULTURAL SOILS

PASCUAL DE VEGA, M.B., SÁNCHEZ-MONEDERO, M.A., CAYUELA, M.L.

Centro de Edafología y Biología Aplicada del Segura CEBAS-CSIC, Murcia. Spain

### INTRODUCTION

Agricultural soils are the main anthropogenic sources of atmospheric nitrous oxide (N<sub>2</sub>O). Biochar, a carbon-rich solid produced by pyrolysis of biomass (Atkinson *et al.*, 2010), has been reported to reduce N<sub>2</sub>O emissions. Its application to soils has been proposed to affect soil N<sub>2</sub>O activity by several mechanisms, some of them biotic and others abiotic. Among them, biochar may alter N-cycling microbial community (Harter *et al.*, 2014), structure and soil functions by reacting with various N forms (nitrate, nitrite and/or N<sub>2</sub>O) (Lin *et al.*, 2014) or acting as a mediator in redox reactions. In particular, recent studies have proposed biochar's involvement in N<sub>2</sub>O reduction to N<sub>2</sub>, the last step of the denitrification process (Cayuela *et al.*, 2013) but, there are still very few of studies that have demonstrated this hypothesis (Quin *et al.*, 2015). To our knowledge, no study has analysed the reduction of N<sub>2</sub>O to N<sub>2</sub> in soil columns amended with several biochars with contrasting properties. Thereby, this experimental approach would allow to link biochar physical and chemical properties with its N<sub>2</sub>O reduction rate.

### MATERIAL AND METHODS

Several column incubation experiments with soil/biochar mixtures (2% biochar) have been set up under different moisture contents (40 and 90% WFPS). N<sub>2</sub>O was injected at the bottom of the soil column and measured at the headspace at regular time intervals. The biochars used were produced at two pyrolysis temperatures (400 and 600°C) and generated from two agricultural residues (pruning residues from olive tree and post-harvest residues from tomato plants). The evolution of N<sub>2</sub>O concentration with time was monitored, as well as CO<sub>2</sub> and CH<sub>4</sub> concentrations in the headspace by using a gas chromatograph (VARIAN CP-4900 Micro-GC. Palo Alto, CA, USA).

Biochars were chemically and physically analysed. In all of them, pH, electrical conductivity, total N, C, H, O, metal, ash and moisture concentrations were determined. Moreover, the micro-structure, pore size distribution, porosity and total surface area of the biochars were measured by a mercury intrusion-extrusion technique. In addition, the percentage of lignin, hemicellulose, cellulose and ash on both feedstock used for biochar production were quantified.

### RESULTS AND DISCUSSION

Previous laboratory experiments have demonstrated the ability of biochar to decrease N<sub>2</sub>O emissions; however, there is almost no information on how biochar impact specific N<sub>2</sub>O formation and consumption pathways (Cayuela *et al.*, 2013; Quin *et al.*, 2015). Recently, Thomazini *et al.* (2015) argued that the inconsistent results found in the literature regarding biochar impact on N<sub>2</sub>O emissions are mostly a result of the variability in biochar properties. We postulate that, in general, all biochars will increase the soil N<sub>2</sub>O sink capacity, i.e. the reduction of N<sub>2</sub>O to N<sub>2</sub>. A combination of biochar factors could take part: their porosity, redox activity (capacity to accept and donate electrons), chemical structure (functional groups), physical properties, feedstock composition... Some of them are gathered in Table 1 and 2.

We contemplate that biochars with a lower molar H:C<sub>org</sub> ratio and a higher aromaticity (generally found in biochars produced at high temperatures) would facilitate the electron exchange between the biochar surface and the microorganisms involved in N<sub>2</sub>O reduction. Biochars porosity may also play a significant role because it provides biochars the capacity to adsorb gases and modulate their diffusion to the atmosphere (Cayuela *et al.*, 2013 and 2015). In addition, the lignocellulosic composition of the feedstock may affect the chemical groups (e.g.

hydroquinone and phenolic moieties) present in biochar and therefore its electron donor capacity (Zhao *et al.* 2013).

Table 1. Olive tree and tomato plants biochar properties at 400 and 600°C.

Biochars	Feedstock	T pyrolysis (°C)	pH	CE (mS/cm)	Ash (%)	H:C	C:N
BC-OI400	Olive tree	400	9,90	0,59	4,89	0,130	107,51
BC-OI600		600	11,05	0,75	4,81	0,246	105,95
BC-To400	Tomato plants	400	9,65	18,43	34,43	0,801	22,91
BC-To600		600	12,10	22,80	38,18	0,337	26,58

Table 2. Biochar feedstock content (%) in lignin, hemicellulose, cellulose and ash.

Feedstock	Lignin (%)	Hemicellulose (%)	Cellulose (%)	Ash (%)
Olive tree	25	17	56	3
Tomato plants	17	3	50	31

## CONCLUSION

The term biochar comprises a wide range of pyrolysed materials with contrasting physico-chemical properties. How the individual properties of biochar impact the reduction of N<sub>2</sub>O to N<sub>2</sub> in soil is to date unknown. However, with the results from the incubation experiments and the detailed characterization of the biochars tested, we will be able to ascertain the properties of biochar related to its N<sub>2</sub>O reduction capacity. This will pave the way for a future development of biochars with the environmental goal of reducing N<sub>2</sub>O emissions in agricultural soils.

**Acknowledgements:** We thank the Ministry for the Economy and Competitiveness of Spain. Project: Ref. CTM2015-67200-R (MINECO/FEDER).

## REFERENCES

- Atkinson, C.J., Fitzgerald, J.D., Hipps, N.A. Potential mechanisms for achieving agricultural benefits from biochar application to temperate soils: a review. *Plant Soil* 337,1–18 (2010)
- Cayuela, M.L., Sánchez-Monedero, M.A., Roig, A., Hanley, K., Enders, A., Lehmann, J. Biochar and denitrification in soils: when, how much and why does biochar reduce N<sub>2</sub>O emissions? *Sci. Rep.* 3, 1732 (2013)
- Cayuela, M. L., Jeffery, S., Van Zwieten, L. The molar H:Corg ratio of biochar is a key factor in mitigating N<sub>2</sub>O emissions from soil. *Agr. Ecosyst. Environ.* 202, 135–138 (2015)
- Harter J., Krause, H-M., Schuettler, S., Ruser, R., Fromme, M., Scholten, T., Kappler, A., Behrens, S. Linking N<sub>2</sub>O emissions from biochar-amended soil to the structure and function of the N-cycling microbial community. *ISME J.* 8, 660–674 (2014)
- Lin, X., Spokas, K.A., Venterea, R.T., Zhang, R., Baker, J.M., Feyereisen, G.W. Assessing Microbial Contributions to N<sub>2</sub>O Impacts Following Biochar Additions. *Agron.* 4, 478–496 (2014)
- Quin, P., Joseph, S., Husson, O., Donne, S., Mitchell, D., Munroe, P., Phelan, D., Cowie, A., Van Zwieten, L. Lowering N<sub>2</sub>O emissions from soils using eucalypt biochar: the importance of redox reactions. *Sci. Rep.* 5, 16773 (2015)
- Thomazini, A, Spokas, K., Hal, K., Ippolito, J., Lentz, R., Novak, J. *Agri., Ecosystems and Environ.* 207, 183-191 (2015)
- Zhao, L., Cao, X., Mašek, O., Zimmerman, A. Heterogeneity of biochar properties as a function of feedstock sources and production temperatures. *J. Hazard Mater* 256–257, 1–9 (2013)

## MONITORING RNA INDUCTION TO EVALUATE NITROGEN ABSORPTION AND ASSIMILATION FOLLOWING BIOSTIMULANT APPLICATION ON WHEAT (*TRITICUM AESTIVUM* L.)

KREMER, L.<sup>1</sup>, BELVAL, L.<sup>2</sup>, BESSON, M.<sup>3</sup>, MEYER, L.<sup>1</sup>, HAAS, J.<sup>1</sup>, BENBRAHIM, M.<sup>1</sup>

<sup>1</sup> RITMO agroenvironnement, France; <sup>2</sup> Université de Haute Alsace, France; <sup>3</sup> Université de Perpignan Via Domitia, France

### INTRODUCTION

Nitrogen use efficiency (NUE) is an important parameter for agriculture. Recently, new fertilizer additives called biostimulant were proposed by the industry and claimed to have different effects on growth and particularly a positive effect on NUE. The main objective of this study is the use of specific RNAs as indicators for NUE. The method, developed on wheat, is used to evaluate the effects of commercial products on nitrogen absorption and assimilation by measurements of gene expression changes. This includes seven genes in wheat.

### MATERIAL AND METHODS

#### Plant material and growing conditions

Six days old emerged seedlings (20°C, darkness) of spring wheat (*Triticum aestivum* L. var. Lennox) were carefully clamped in individual neoprene foam floaters and maintained for 2 days in tap water (20°C with day/night cycles) before relocation to an hydroponic growth system. One unit of the hydroponic system consisted of a 5 liters plastic tank with a lid where 6 floaters (replicates) were inserted at the surface of the nutrient solution. Hoagland nutrition solution (Hoagland & Arnon, 1950) was used at ¼ dilution to apply sub-optimal nutrient conditions. A bubbling air pump ensured adequate root oxygenation in the solution (15 minutes / 1.5 hour). Hydroponic systems were positioned in a glasshouse and growth continued for 4 weeks (in semi-controlled conditions), renewal of nutrient solution occurred every 2 weeks.

#### Modalities

4 modalities were compared (1 hydroponic system unit per modality): (1) negative control without any treatment, (2) positive control including a nitrate induction, (3) TL treated modality and (4) TT treated modality; TL and TT being two amino acid-based biostimulant products applied at 3.5 L/1000 L nutrient solution. For the positive control undergoing nitrate induction, the 6 plants were transferred in beakers containing a potassium nitrate solution (10 mM) during 4 hours prior the harvest.

#### Roots sampling

At harvest, plants were removed from the floaters, dried on absorbent paper and the root tips were immediately collected and immersed in liquid nitrogen. Then, about 100 mg of root tips were grinded to a fine powder using liquid nitrogen, mortar and pestle and stored at -80°C until the next step.

#### RNA extraction, reverse transcription and quantitative real-time PCR

Total RNAs samples were purified using RNeasy Plant Mini Kit (Bio-Rad), according to the manufacturer's instructions. Quantity and quality of the RNAs samples were checked measuring absorbance at 260 nm and 280 nm (Nanodrop One - Ozyme) and by electrophoresis in a 1% agarose gel. A concentration step using 3 M sodium acetate (pH 5.5) was sometimes necessary. **Reverse transcription was performed** with iScript™ Reverse Transcription SuperMix for RT-qPCR (Bio-Rad) in a MyCycler thermal cycler (Bio-Rad) using 1 µg of total RNA from each root sample, according the manufacturer's instructions. A reverse transcription negative control (without reverse transcriptase) and a non-template negative control (with reverse transcriptase) were included, and the absence of genomic DNA was verified through end-point PCR assays, and during qRT-PCR experiments.

Primer pairs have been designed (and tested for specificity and efficiency in parallel to published primers) to analyse the relative accumulation of transcripts of several genes involved in nitrogen assimilation: nitrate transporters (NRT1.1, NRT1.2, NRT2.1, NRT2.2) and nitrogen assimilation enzymes (nitrate reductase (NR), glutamine synthetase (GS) & glutamine oxoglutarate aminotransferase (GOGAT)). Real-time PCR was performed using iQ SYBR Green Supermix (BIO-RAD) for each target and in triplicate for each RNA sample. Results obtained by the  $2^{-\Delta\Delta C_t}$  method (Livak & Schmittgen, 2001) provided the relative accumulation of transcripts as compared to housekeeping genes (GAPDH & EF1 $\alpha$  were used for nitrate transporters amplification; EF1 $\alpha$  and Ta.14126.1.S1\_at (Long et al., 2010) were used for enzymatic genes amplification). Results were expressed relative to the negative control (untreated) modality.

## RESULTS AND DISCUSSION

The nitrate-induced modality constituted the positive control modality. The figure 1 clearly shows that nitrate induction increased RNA accumulation of NRT2.1 and NRT2.2 by a factor of 6, compared to the negative control. One can suppose that the induction of NRT2 (high affinity nitrate transporters) is linked to the delay between induction and harvest and that a subsequent raise could be observed in later enzymes like NR or GS/GOGAT.

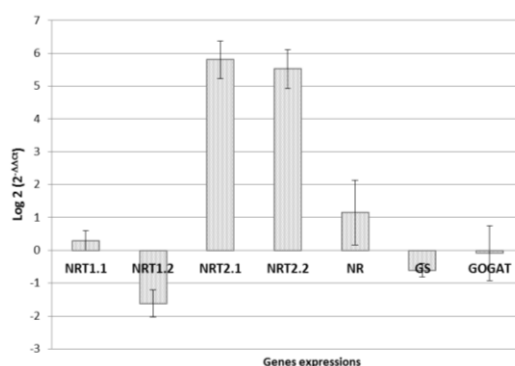

Figure 1. Effect of induction on the relative accumulation of transcripts in positive control modality (average of 5 tests)

Regarding nitrate transporters, the amino acid-based biostimulant products slightly modified NRT1.1 & 1.2, but had no effect on NRT2.1 indeed even a repression on gene NRT2.2 (see Table 1.).

Table 1. Profile of gene expression changes (values represent fold change (Log<sub>2</sub>) in transcript copy number relative to the negative control; bold indicate values that exceed a 3 fold difference in terms of RNA copies compared to negative control .

Target gene	NRT 1.1	NRT 1.2	NRT 2.1	NRT 2.2
Positive control	<b>0,3</b>	<b>-1,6</b>	<b>5,8</b>	<b>5,5</b>
TL biostimulant	<b>1,8</b>	<b>-0,6</b>	<b>-0,3</b>	<b>-1,7</b>
TT biostimulant	<b>2,1</b>	<b>1,5</b>	<b>-0,7</b>	<b>-1,9</b>

## CONCLUSION

The positive control results confirm that gene transcripts could be used to characterize the induced mechanisms of nitrogen assimilation. At the moment, the method allows to monitor 7 genes of wheat, but the compilation of data on other genes (including ammonium transport) is still ongoing, to achieve a complete overview of the different steps from the N cycle.

## REFERENCES

Hoagland D.R. and Arnon D.I. 1950. The Water-Culture Method for Growing Plants without Soil. California Agricultural

Experiment Station, Circular-347.

Livak K.J. and Schmittgen T.D. 2001. Analysis of Relative Gene Expression Data Using Real-Time Quantitative PCR and the  $2^{-\Delta\Delta Ct}$  Method. *METHODS* 25, 402–408

Long X.Y., Wang J.-R., Ouellet T., Rocheleau H., Wie Y.-M., Pu Z.-E., Jiang Q.-T., Lan X.-J. and Zheng Y.-L. 2010. Genome-wide identification and evaluation of novel internal control genes for Q-PCR based transcript normalization in wheat. *Plant Mol Biol* 74:307-311



## EFFECTS OF A NATURAL NITROGEN-NUTRITIONAL AGENT ON WINTER WHEAT (*TRITICUM AESTIVUM*)

BRAS, P.Y. , LEVIVIER, S. KLARZYNSKI, O.

1R&D Department, Bio3G, 7 rue du Bourg Neuf, 22 230 Merdrignac, FRANCE

### INTRODUCTION

Nitrogen (N) is an essential nutrient used in agricultural fields and, as a consequence, a large amounts of N fertilizers are used throughout the world. The efficiency of N fertilizers by crops in arable lands is relatively low, ranging from 25% to 50% of the applied N (Chien et al., 2016; Dobermann et al., 2003). Several methods are used to manage its efficiency in order to reduce nitrogen losses (Sharma et al., 2017). The majority of them are based on technical tools and agronomic knowledge (calculations and estimates) and only a few works target the use of natural substances and biostimulants to improve N fertilization. The R&D Bio3g team has developed a foliar biostimulant (seaweed-extracts and glutamic acid) in order to improve the nitrogen uptake and its efficiency, with a focus on cereals. Multiple experiments were conducted on various scales. The project was initiated under controlled conditions, in experimental greenhouse, with some trials under different fertilization regimes. Afterwards, transcriptomic analyses were carried out to understand the mode of action of the product. Lastly, in the field, the integration of this new solution into crop management techniques has been tested.

### MATERIAL AND METHODS

#### Greenhouse trials

In 2012, a test was conducted under controlled conditions on soft winter wheat at the National Institute for Agricultural Research (INRA Rennes, France). 3 doses of the biostimulant (X; 5X; 10X) and a untreated control were compared. 3 sprays were carried out during nitrogen fertilization inputs (tillering [2-3]; pseudo-stem erection [4-5]; inflorescence emergence [10]). Nitrogen-limiting fertilization was tested (70% of the original needs). Statistical analysis details: Anova,  $\alpha = 5\%$ , post-hoc test = Newman-Keuls.

#### Transcriptomic analyses

Seedlings of *A. thaliana* are grown in a climate chamber (day = 22 °C; night = 19 °C; photoperiod = 16 h). The product is sprayed with water (dose X; dilution factor = 100). 5 plants are used by modality (product and referent). Leaves are taken at 48 h after treatment and directly placed in RNeasy Stabilization Reagent. The tissues and total RNA are extracted with Tissue Lyser (Qiagen) and “RNeasy Protect Mini Kit + DNase 1 treatment” respectively. In vitro transcription with T7 polymerase precede retrotranscription step with dCTP-Cy3 or Cy5 and purification and quantification of the embedded fluorochromes. Hybridization (30 pmoles per sample/ AGILENT blade) was performed at 42 ° O/N in the presence of formamide.

#### Field experiments

Between 2012 and 2013, 4 trials in real agricultural conditions were performed on winter wheat in western France (Bretagne and Nouvelle-Aquitaine). Experiments were carried out in microplots of 25 m<sup>2</sup>. 3 stages of implementation in line with nitrogen fertilization inputs (tillering [2-3]; pseudo-stem erection [4-5]; inflorescence emergence [10]) have been studied. 3 conditions were explored (0.1X; X; referent). On each experimental site, each microplot received the same nitrogen fertilization, based on the objective of the crop yield and soil supplies (physicochemical analysis). Statistical analysis details: Anova,  $\alpha = 5\%$ , post-hoc test = Newman-Keuls.

### RESULTS AND DISCUSSION

#### Greenhouse trials

In Nitrogen-limiting fertilization, grain yield has been improved with the 3 concentrations used (results statistically significant). However, the amount of straw was amplified solely at dose X (results not shown here, statistical significance). These results allowed us to identify the more efficient dose of the product.

Table 1. Average efficiency as a percentage of the Referent Datas on grey background show measured values whereas datas on white background are relative to the reference on a 100-basis.

Mod	amount of straw (g/plant)	Dry grain yield (q ha <sup>-1</sup> )
REF	18.4 b	9.5 b
X	122.3 a	114.8 a
5X	100.5 b	119.8 a
10X	93.4 b	115.4 a

### Transcriptomic analyses

The effect of the biostimulant on genes is large. 509 genes are induced and 234 genes are inhibited. Many genes of interest in nitrogen metabolism are overexpressed like ATNRT2.6 (*Arabidopsis thaliana* high affinity nitrate transporter 2.6: IF = 4.12) or ATGSTU10 (*Arabidopsis thaliana* Glutathione S-transferase (class tau) 10: IF = 2.82). As such, this innovative solution can be considered as a stimulator of nitrogen metabolism.

### Field experiments

These results obtained in the fields show that this biostimulant improves the yield of crops from 8% to 14%. The best gain is achieved with dose X (+11 q ha<sup>-1</sup>). Differences are statistically significant in 3 out of 4 sites (Anova,  $\alpha = 5\%$ , post-hoc test = Newman-Keuls). This quantitative benefit also tends to enhance grain quality (protein and TKW), these results being statistically significant only in one trial.

Table 2. Average efficiency as a percentage of the Referent Datas on grey background show measured values whereas datas on white background are relative to the reference on a 100-basis. Results in bold were statistically significant in 3 out of 4 sites.

Trial	Mod	Dry grain yield (q ha <sup>-1</sup> )	Protein (% dry)	1000-kernel-weight (g)	Specific weight (kg hL <sup>-1</sup> )
4 trails average 2012-2013 (min - max)	REF	80.9 (69.4 - 86.4)	10.1 (8.9 - 11.6)	48.8 (44.8 - 56.4)	76.2 (73.9 - 80.0)
	0.1X	<b>108</b> (105 - 110)	102 (101 - 105)	102 (97 - 104)	102 (101 - 102)
	X	114 (101 - 129)	102 (96 - 109)	102 (97 - 104)	100 (99 - 101)

### CONCLUSION

This serie of experiments clearly demonstrated the effect of this new solution. The dose X improves the nitrogen effect in wheat. The effect acts on the quantitative yield without diminishing the quality of the grain harvested. This biostimulant performs a positive role in the nutrient use efficiency (NUE) on winter wheat. In 2016, this biostimulant was registered in France and commercialized under the name ALTERNAZOTE.

### REFERENCES

Chien S.H., Teixeira L.A., Cantarella H., Rehm G.W., Grant C.A., Gearhart M.M., 2016. Agronomic effectiveness of

granular nitrogen/phosphorus fertilizers containing elemental sulfur with and without ammonium sulfate. A Review. *Agron. J.* , 108, 1203.

Dobermann A., Ping J.L., Adamchuk V.I., Simbahan G.C., Ferguson R.B., 2003. Classification of Crop Yield Variability in Irrigated Production Fields. *Agron. J.* 95, 1105.

Sharma L.K., Bali S.K., 2017. A Review of Methods to Improve Nitrogen Use Efficiency in Agriculture. *Mdpi journal. Sustainability*, 10(1), 51.

## EFFECTS OF ORGANIC WASTE APPLICATION ON N<sub>2</sub>O EMISSIONS AND N LEACHING IN SUGARCANE PLANTATION SOILS IN REUNION ISLAND

POULTNEY, D.M<sup>1</sup>, VERSINI, A.<sup>1</sup>, THURIES, L.<sup>1</sup>

<sup>1</sup> CIRAD, UPR Recyclage et risque, 97743 Saint-Denis, La Réunion, France

### INTRODUCTION

Reunion Island is a densely populated Overseas Territory of France in the Indian Ocean. There is an increasing need for waste management, given the rising population density and the associated waste production increase. This waste can take the form of human waste (sewage sludge) and livestock waste (animal manure). The primary means of valorizing this waste would be as organic fertiliser in agroecosystems. Sugarcane is the most abundant crop on the island, spanning 58 % of the 43 000 hectares allocated as agricultural territory, across 9272 farms (Agreste DAAF, 2015).

N is an essential nutrient for crop growth and development, and is frequently a limiting factor in sugarcane agroecosystems. Despite the clear benefits of N fertilisers in contributing to adequate crop nutrition, excessive amounts accumulated in terrestrial and aquatic ecosystems can lead to a significant impact on environmental quality, ecosystems, biodiversity and human health (Dobermann, 2005). Environmental impacts linked to the N cycle include the loss of N to the atmosphere in the form of nitrous oxide (N<sub>2</sub>O) during the process of denitrification. N<sub>2</sub>O is a major greenhouse gas contributing to global warming, and agricultural soils are the most significant anthropogenic sources of N<sub>2</sub>O (Allen *et al.*, 2010). Excess N is also lost from soils via leaching mainly in the form of nitrates. Agricultural fertilisers are major contributors to increased concentrations of N in groundwater (Ghiberto *et al.*, 2009). Eutrophication occurs when an excess of leached N reaches fresh water, which has negative effects on marine and freshwater ecosystems, and can render the water unsuitable for human consumption.

This study, which is the research project of a Doctor of Philosophy degree, is currently in its first year of implementation. It investigates the impact of recycling agricultural organic residue on the biogeochemical cycle of nitrogen in Reunion Island. The study is conducted on a SOERE-PRO site, which is a network of long-term field experimental sites, where the objective is to observe the effects of agricultural organic waste application on the different compartments of crops. The agricultural organic waste fertilisers are sewage sludge, pig manure and poultry manure. The mineral fertiliser used is urea, which is the standard fertiliser used on sugarcane farms in Reunion.

The primary objective of this study is to determine the environmental impact of organic fertiliser, as compared to mineral fertilisation. More specifically, N<sub>2</sub>O emissions and NO<sub>3</sub><sup>-</sup> leaching will be assessed.

### MATERIAL AND METHODS

The SOERE-PRO network in Reunion Island is closely situated to the island's capital, Saint-Denis (Lat 20°54'12.2"S, 55°31'46.6"E). The site is characterized by a tropical climate with an average annual temperature of 25°C and annual precipitation of 1650 mm. The trial was planted in March 2014 from viable buds of the R579 sugarcane variety placed with 1.5 m spacing between rows. The trial consists of 6 plots, each with a different fertiliser treatment, which is repeated in 5 blocks, with each plot made up of 6 sugarcane rows of 28 m, constituting a total plot area of 250 m<sup>2</sup>.

N leaching in the soil is studied using a mixed system, consisting of porous cups under tension at depths of 10 and 40 cm; and lysimetric plates at a depth of 1 m. The vertical dynamic of DON, NH<sub>4</sub> and NO<sub>3</sub> in solution is studied in the different treatments. Finally, a mass balance of the loss of N by drainage flux at a depth of 1 m will be established with the aid of a computational model simulating hydric flux.

The annual flux of N<sub>2</sub>O is estimated for the different treatments using 12 automatic chambers linked to a gas analyser. These semi-continuous measures allow the temporal variability of N<sub>2</sub>O emissions to be studied, in the original context of organic waste application in tropical conditions.

## RESULTS AND DISCUSSION

The amount of N found at different soil depths (10 cm, 40 cm and 100 cm) are presented for the month of fertilizer application and the first three months following application (Figure 1). The proportion of N derived from fertiliser was also calculated for the three respective depths over the first three months. For the soil depths of 10 cm, 40 cm and 100 cm, the proportion of N derived from urea fertilisation was 5.2 %, 3.4 % and 0.5 %; the proportion of N derived from sewage sludge fertilisation was 11.7 %, 5.3 % and 0.8 %; and the proportion of N derived from pig manure fertilisation was 31.7 %, 14.4 % and 0.4 % respectively.

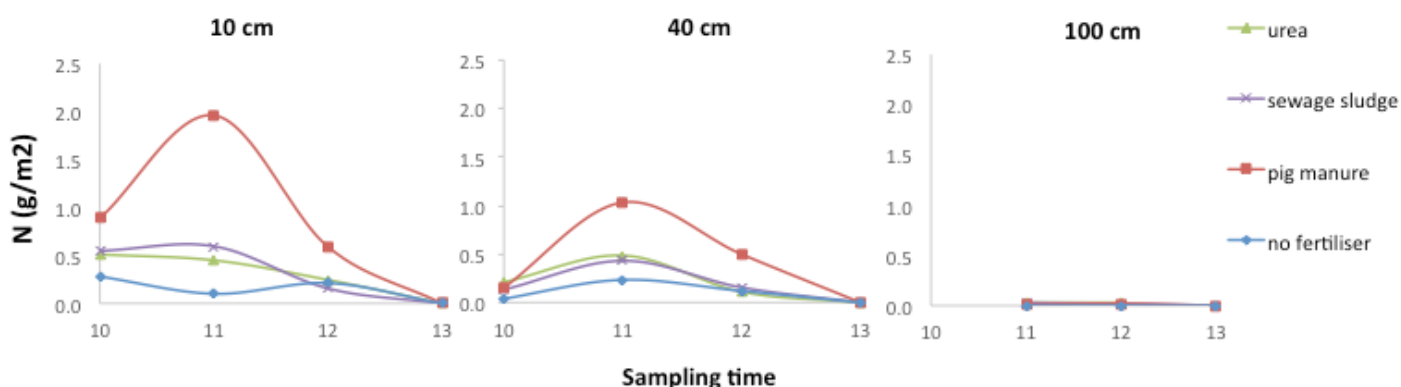

Figure 1. Nitrogen amount for the different fertiliser treatments (urea, sewage sludge, pig manure, no fertiliser) at sampling times  $t_0$ ,  $t_1$ ,  $t_2$ ,  $t_3$  at depths of 10 cm, 40 cm and 100 cm.

There is a large increase in the quantity of N found in pig manure after the first month in the 10 cm and 40 cm soil depths, but this does not reach the 100 cm depth. The N amount in the other treatments remains relatively stable over the first month at depths of 10 cm and 40 cm. There is an overall decrease in N across treatments in the second month reaching a quantity of 0 g.m<sup>-2</sup> three months after fertilisation. N does not reach the 100 cm soil depth, showing that there is minimal loss of N by deep drainage during the first three months following fertilisation.

## REFERENCES

- Allen, D. E., Kingston, G., Rennenberg, H., Dalal, R. C., & Schmidt, S. (2010). Effect of nitrogen fertilizer management and waterlogging on nitrous oxide emission from subtropical sugarcane soils. *Agriculture, Ecosystems & Environment*, 136(3-4), 209-217.
- Agreste DAAF La Réunion, 2015. Enquête sur la structure des exploitations agricoles en 2013. Ministère de l'Agriculture, de l'Agroalimentaire et de la Forêt – Service de la Statistique et de la Prospective. Agreste Analyses n°95.
- Dobermann, A.R., 2005. Nitrogen Use Efficiency – State of the Art. IFA International Workshop on Enhanced-Efficiency Fertilisers, Frankfurt, Germany, 28-30.
- Ghiberto, P. J., Libardi, P. L., Brito, A. S., & Trivelin, P. C. O. (2009). Leaching of nutrients from a sugarcane crop growing on an Ultisol in Brazil. *Agricultural Water Management*, 96(10), 1443-1448.

## N<sub>2</sub>O MITIGATION POTENTIAL OF N-STABILIZERS APPLIED WITH UREA TO WINTER OILSEED RAPE

THIEL, E., SPOTT, O., KREUTER, T., LIETSCH, A., SCHUSTER, C.

SKW Stickstoffwerke Piesteritz GmbH, Department Research and Development, Möllendorfer Strasse 13,  
06886 Wittenberg, Germany

### INTRODUCTION

Winter oilseed rape is the most important oil crop cultivated in Europe. Production related N<sub>2</sub>O emissions are increasingly coming to the fore in the course of biofuel production and European emission reduction goals. Most recent estimates revealed a mean N<sub>2</sub>O loss of 0.6% fertilizer-N (Ruser et al., 2017) and hence, below the current IPCC factor of 1.0% (De Klein et al., 2006). An application of a nitrification inhibitor (NI) along with urea and/or ammonium-based fertilizers was reported to additionally decrease N<sub>2</sub>O emissions by ≈35% on average (Ruser et al., 2015). However, winter oilseed rape is in particular characterized by large amounts of N-rich crop residues and thus, relevant N<sub>2</sub>O emissions not only occur soon after fertilization (directly based on applied mineral N), but also later on during maturity, harvest and afterwards based on their N-rich crop residues (Walter et al., 2015; Ruser et al., 2017). While the former N<sub>2</sub>O loss can be mitigated by the application of a NI, the latter is far beyond the scale of NI effectiveness. The present study therefore aimed at evaluating the N<sub>2</sub>O emission dynamic of winter oilseed rape after fertilization with urea under practice-related field conditions, particularly focusing on the NI effectiveness during different stages of plant development.

### MATERIAL AND METHODS

**Experimental Site** – Field experiments have been conducted at the Agricultural Experimental Station Cunnernsdorf in Central Germany (51°22'N, 12°33'E; 130 m a.s.l.;  $\varnothing$  9.1°C;  $\varnothing$  620 mm; Podzoluvisols; sandy loam, pH 6.5, C<sub>org</sub> 1.1%, N<sub>t</sub> 0.12%). Investigations occurred in the cropping period 2014/15 and 2015/16 using winter oilseed rape PX 104 (semi-dwarf).

**Experimental Design** – Field plots (each 1,6 x 8,5 m) were designed as a Latin square with the fertilizer treatments granular urea (U), granular urea + urease inhibitor 2-NPT (U+UI) and granular urea + urease & nitrification inhibitor MPA (U+UI+NI) as well as an unfertilized control (C), each with four replicates (in total 16 plots). According to common practice the total number of fertilizer applications can be reduced by one when a NI is added to a fertilizer. Therefore, fertilization occurred twice a year (beginning and end of March) without NI application (U & U+UI) and only once a year (end of February) in case of NI application (U+UI+NI). Total N input was 180 kg N ha yr<sup>-1</sup> independent of the number of fertilization events.

**N<sub>2</sub>O Emission** – Emission measurements have been conducted (around noon) at least twice a week and additionally after rain events from February to September 2015 and February to August 2016, respectively, using a closed-chamber approach (Hutchinson & Mosier, 1981). One opaque chamber (volume ca. 350 L / area 0,56 m<sup>2</sup>) was placed at each field plot (n=16) by using a permanently installed chamber frame at the plot center. After closing four aliquot gas samples per chamber were taken by pre-evacuated glass vessels (100 ml after 0, 25, 50 and 75 min closure) and later on analyzed for N<sub>2</sub>O (and CO<sub>2</sub>) by gas chromatography. Calculation of emission was based on linear regression of at least three plausible concentration values per emissions measurement (2015 88% and 2016 95% of complete data set).

**Soil N<sub>min</sub>** – Soil mineral N (NH<sub>4</sub><sup>+</sup>, NO<sub>3</sub><sup>-</sup>) was analyzed (mainly) in parallel with emission measurements. Analysis was based on one composite soil sample (0-30 cm depth) per plot using CaCl<sub>2</sub> extraction (DIN 19746) and photometric detection afterwards.

**Soil water content** – Soil water content was analyzed in parallel with soil N<sub>min</sub> by determination of drying loss (105 °C for 2 h). Afterwards water filled pore space (=WFPS) was calculated based on mean dry bulk density of the

soil which was determined once a year by three parallel soil core samples (100 cm<sup>3</sup>, 5 cm depth) from one plot of each treatment (n=12).

## RESULTS AND DISCUSSION

Estimated total N<sub>2</sub>O loss after urea fertilization ranged from 1.15 to 1.36 kg N ha<sup>-1</sup> in 2015 and 0.44 to 0.91 kg N ha<sup>-1</sup> in 2016. In total this corresponds to 0.10 to 0.44 % fertilizer-N. Regarding total investigation period (Feb to Aug/Sep) only in 2016 NI application did significantly reduce N<sub>2</sub>O emissions. This was primarily caused by differences in the N<sub>2</sub>O emission dynamic throughout the investigation period of both years.

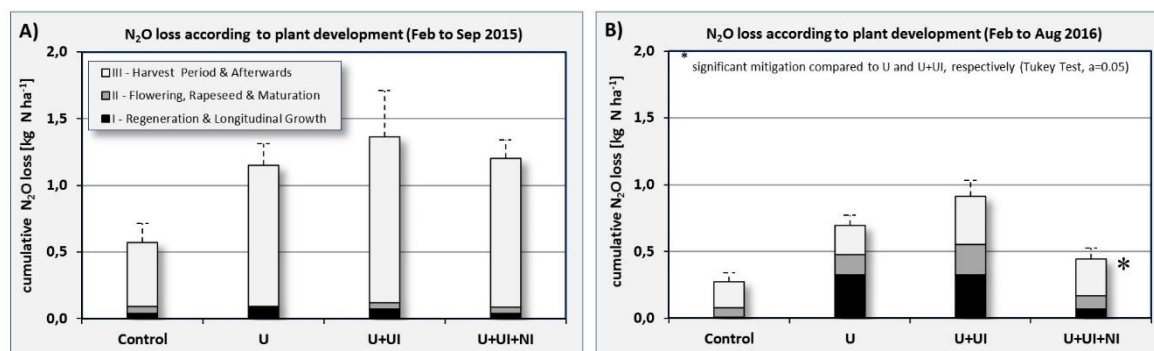

Figure 1 Cumulative N<sub>2</sub>O loss after urea fertilization to winter oilseed rape in (A) 2015 and (B) 2016 summarized according to plant development stages (2015: Phase I – Feb-Apr, Phase II – May-Jun, Phase III – Jul-Sep; 2016: Phase I – Feb-Apr, Phase II – May-Jun, Phase III – Jul-Aug)

In 2015 >90 % of total N<sub>2</sub>O loss (1.06-1.24 kg N ha<sup>-1</sup>) occurred around harvest and afterwards (July to September, Fig. 1A) when fertilizer based mineral N was already completely depleted at that time. By contrast, N<sub>2</sub>O loss was very low (max. 0.09 kg N ha<sup>-1</sup>, ≈7 % of total N<sub>2</sub>O loss) in the fertilization period (February to April) due to low soil moisture (29-66% WFPS). As a consequence, in 2015 total N<sub>2</sub>O loss was not lowered by NI application, even if soil N<sub>2</sub>O release was reduced at least within the fertilization period by 97%. By contrast, N<sub>2</sub>O loss was significantly higher within the fertilization period of 2016 (up to 46% of total N<sub>2</sub>O loss, ±0.33 kg N ha<sup>-1</sup>) due to markedly higher soil moisture (76-91% WFPS). Within this phase NI application reduced N<sub>2</sub>O loss by 81%. Since afterwards (May to August 2016) significantly less N<sub>2</sub>O was emitted (≈0.37-0.59 kg N ha<sup>-1</sup>) total N<sub>2</sub>O mitigation by NI application remained high at ultimately around 60%. Despite strong differences in total mitigation potential between both years as discussed above N<sub>2</sub>O release during the fertilization period of 2015 and 2016 was equally reduced concerning a relative scale (i.e. 97% 2015 and 81% 2016).

## CONCLUSION

Determined N<sub>2</sub>O loss after urea fertilization to winter oilseed rape was 1.36 kg N ha<sup>-1</sup> in maximum (0.44% fertilizer-N) and thus, remained below the current IPCC factor of 1.0% (De Klein et al., 2006). Similar results have been recently reported by Ruser et al. (2017). Regarding fertilization period from February till April (begin of flowering) NI application significantly reduced N<sub>2</sub>O release (81-97%). Soil N<sub>2</sub>O loss around harvest and also afterwards isn't fed directly by fertilizer based mineral N, but results from fresh biomass which is inherently increased in fertilized systems and irreducible by NI application along with fertilization. Consequentially, total N<sub>2</sub>O mitigation potential gained by NI application largely depends on the N<sub>2</sub>O emission strength within the period of NI effectiveness (until flowering) as well as during the harvest period and afterwards.

## REFERENCES

De Klein C., Novoa R.S.A., Ogle S., Smith K.A., Rochette P., Wirth T.C., 2006. N<sub>2</sub>O Emissions from managed soils, and CO<sub>2</sub> emissions from lime and urea application, in: Egglestone S., Buendia L., Miwa K., Ngara T., Tanabe K.

- (Eds.), 2006 IPCC Guidelines for National Greenhouse Gas Inventories – Volume 4. IGES, Japan.
- Hutchinson, G. L., Mosier, A. R., 1981. Improved soil cover method for field measurement of nitrous oxide fluxes. *Soil Sci. Soc. Am. J.*, 45, 311-316.
- Ruser R., Schulz R., 2015. The effect of nitrification inhibitors on the nitrous oxide (N<sub>2</sub>O) release from agricultural soils - a review. *Journal of Plant Nutrition and Soil Science*, 178, 171-188.
- Ruser R., Fuß R., Andres R., Hegewald R., Kesenheimer K., Köbke S., Rübiger T., Suarez Quinones T., Augustin J., Christen O., Dittert K., Kage H., Lewandowski I., Prochnow A., Stichnothe H., Flessa H. 2017. Nitrous oxide emissions from winter oilseed rape cultivation. *Agriculture, Ecosystems and Environment*, 249, 57-69.
- Walter K., Don A., Fuß R., Kern J., Drewer J., Flessa H., 2015. Direct nitrous oxide emissions from oilseed rape cropping - a meta-analysis. *Global Change Biology – Bioenergy*, 7, 1260-1271.



## EFFECT OF DELAYED N APPLICATION ON SPRING BARLEY PRODUCTIVITY

HACKETT, R.

Teagasc, Crops Research Centre, Carlow, Ireland.

### INTRODUCTION

Spring barley is currently the main arable crop in Ireland with the majority being grown for animal feed but an increasing proportion being grown for use in malting. Fertiliser N is an important factor in determining crop yield and in the case of malting barley fertiliser N has a large influence on grain protein concentration. In Ireland the recommended fertiliser N dose for spring barley is based on the use of 'Look up tables' which determine the dose to be applied based on a limited number of parameters (previous crop and an estimate of expected yield which is calculated using historic yields). Fertiliser N is typically applied to spring barley in two doses, with a portion being applied at sowing and the remainder applied before the end of the tillering stage. In the current system no account is taken of actual crop growth and the system leaves little scope to adjust fertiliser N inputs based on actual growth or crop N status since all fertiliser is applied before the crop has produced a significant amount of biomass.

Delaying a portion of the fertiliser N until later in the growing season could allow actual crop growth and crop N status to be taken into account to adjust the total N dose. However, delaying a portion of N could subject the barley crop to periods of deficiency which could have a negative effect on grain yield. The objectives of this work were to determine the effect of delaying a portion of the fertiliser N dose until later than is normal in the growing season, on crops that had received sub-optimum levels of fertiliser N at the normal timing.

### MATERIAL AND METHODS

An experiment was carried out in 2015 at the Teagasc Crops Research Centre, Carlow, Ireland. The experiment was laid out as an alpha design with four replications. Plot size was 2.3 m x 12 m. Fertiliser N rates ranging from 0 to 240 kg N ha<sup>-1</sup> with 30 kg N ha<sup>-1</sup> increments were included in the trial where 30 kg N ha<sup>-1</sup> of the total was applied at sowing and the remainder applied during the tillering stage; this is referred to as the 'Standard N' treatment. No further fertiliser N was applied to these treatments. Additional 'Delayed N' treatments were established where two 'basal' N rates (90 and 120 kg N ha<sup>-1</sup>), that were expected to be sub-optimal for grain yield, were applied as already described i.e. application completed before the end of the tillering stage. Additional N, as a third application, was applied to these treatments at either GS31/32 or GS37/39. For each 'basal' N rate a range of additional N rates, in 30 kg N ha<sup>-1</sup> increments up to a maximum total (basal + additional N) N application of 240 kg N ha<sup>-1</sup>, was applied e.g. for the 90 kg N ha<sup>-1</sup> 'base' rate either 30, 60, 90, 120 or 150 kg N ha<sup>-1</sup> was applied at either GS31/32 or GS37/39 to give total N application rates ranging from 120 to 240 kg N ha<sup>-1</sup>.

All fertiliser was applied as CAN (Calcium ammonium nitrate). Crops received all other inputs as per standard farm practice. Grain yield was determined at maturity using a combine harvester and grain protein was determined using an Infratec 1241 grain analyser (Foss, Hillerød, Denmark).

To compare the effect of the 'Delayed N' treatments to the 'Standard N' treatment the experiment was deemed to comprise of two overlapping factorial designs, one where the 'basal' rate was 90 kg N ha<sup>-1</sup> and one where the 'basal' rate was 120 kg N ha<sup>-1</sup>. The factorial treatments were timing of the last application of N (before end of tillering, GS31/32 or GS37/39) and total N rate applied (120-240 for the 90 kg N ha<sup>-1</sup> basal rate and 150-240 for the 120 kg N ha<sup>-1</sup> basal rate). This allowed comparisons to be made where the same total amount of fertiliser N had been applied according to either the 'Standard N' or 'Delayed N' protocol. Procedures described by Piepho *et al.* (2006) were used to analyse these factorial subsets of the data taking error variation for the whole experiment into account. The economic optimum N rate, for the 'Standard N' treatment, was calculated by

equating the first derivative of a quadratic response equation, fitted to grain yield data, to a fertilizer to-grain price ratio of 7:1. Analysis of variance was carried out using Proc Mixed of SAS 9.4

## RESULTS AND DISCUSSION

The economic optimum N rate, where all fertilizer N was applied before the end of tillering, was 169 kg N ha<sup>-1</sup>. This confirms that the basal dose of N applied to both 'delayed N' treatments before the end of tillering was sub-optimal for yield. Effects of timing of the final N application on grain yield and grain protein concentration are presented in Table 1. There was no significant interaction between timing of the last N application and N rate for grain yield for either basal N application rate. Where additional N was applied to the 'delayed N' treatments at GS31/32 grain yield was either similar or significantly higher compared to where all N had been applied before the end of tillering. Where additional N was not applied until GS37/39 yield was significantly reduced where only 90 kg N ha<sup>-1</sup> had been applied previously; where 120 kg N ha<sup>-1</sup> had been applied before the end of tillering delaying the additional N until GS37/39 did not cause a significant yield reduction compared to where all N had been applied before the end of tillering. This suggests that negative effects on yield of delaying N until GS37 are only likely to occur where a relatively large deficiency has developed.

Delaying N application until GS37/39 caused a significant increase in grain protein concentration compared to where all N was applied before the end of tillering irrespective of whether a basal rate of 90 or 120 kg N ha<sup>-1</sup> had been applied. The effect was more pronounced where a base rate of 90 kg N ha<sup>-1</sup> was applied as a result of the lower grain yield obtained in that treatment where final N was delayed until GS37/39. Delaying final N application until GS 31/32 had no significant effect on grain protein concentration.

*Table 1. Effect on grain yield and grain protein concentration of delaying a portion of fertilizer N dose until GS31/32 or GS 37/39 compared to where all N was applied before the end of tillering. Delayed N was applied where a base rate of either 90 kg N/ha or 120 kg N/ha had been applied before the end of tillering. Data are means of four (basal 120 treatment) or five (basal 90 treatment) N rates.*

Timing of final N	Grain yield (t ha <sup>-1</sup> )		Protein concentration (%)	
	Basal 90	Basal 120	Basal 90	Basal 120
Tillering	7.39 a	7.32 b	9.6 a	10.1 a
GS 31/32	7.22 a	7.59 a	9.6 a	10.3 a
GS 37/39	6.67 b	7.28 b	10.3 b	10.7 b

*Means within a column with the same letter are not significantly different (P<0.05)*

## CONCLUSION

Delaying a portion of the N dose for spring barley until later in the season than would normally happen in commercial practice is unlikely to have a significant impact on grain yield provided a large, prolonged deficiency is not allowed to develop. This suggests that there is potential to delay the final decision as to the total dose of fertiliser N to apply to spring barley when monitoring of crop nitrogen status could be used to guide the decision.

## REFERENCES

Piepho H.P., Williams E.R. and Fleck M., 2006. A note on the analysis of designed experiments with complex treatment structure. *HortScience*, 41,446-452.

## N<sub>2</sub>O SOIL EMISSIONS AFTER BIOCHAR AMENDMENT: CONTRASTING RESPONSES DEPENDING ON THE ORIGINAL FEEDSTOCK

SÁNCHEZ-GARCÍA, M.<sup>1</sup>, SÁNCHEZ-MONEDERO, M.A.<sup>1</sup>, CAYUELA, M.L.<sup>1</sup>

<sup>1</sup>Department of Soil and Water Conservation and Waste Management, CEBAS-CSIC. Campus Universitario de Espinardo P.O. Box 164, 30100 Murcia (Spain)

### INTRODUCTION

It has been demonstrated that biochar addition to soils reduces N<sub>2</sub>O emissions in most cases (Cayuela et al., 2014). In this sense, molar O/C and H/C ratios are considered useful indicators to evaluate biochar recalcitrance and its potential in reducing GHG emissions (Spokas, 2010; Cayuela et al., 2015). Nevertheless, biochar properties depend on their feedstocks as well as on the pyrolysis conditions such as heating rate, highest pyrolysis temperature or residence time (Downie, 2011). Thus, generalizations about biochar GHG mitigation potential remain elusive due to the high heterogeneity of biochar properties and reactivity in soils.

In an effort to elucidate how biochars made from different feedstocks would affect N<sub>2</sub>O release from agricultural soils, laboratory soil incubations in optimum conditions for denitrification were conducted. Eleven residues from the agricultural and agro-industrial sector widely available in the Mediterranean area were selected as feedstocks.

### MATERIAL AND METHODS

#### Soil and biochar characterization

A fine texture silty clay agricultural soil (Calcic xerosol, USDA classification) was selected to perform the experiments. It was collected from a grapevine cultivated land located in Totana (Murcia, coordinates: 37° 47' N, 1° 34' W), air dried and sieved below 2 mm. The soil pH was 8.7 and EC 177  $\mu\text{S cm}^{-1}$  (water extract, 1:20 w:w 25°C). Biochars were obtained from pyrolysis of eleven different feedstocks at 600°C with a residence time of 2 h. Feedstocks were obtained from crop residues (primary feedstocks) and from agro-wastes derived from the subsequent agro-industrial processing (secondary feedstocks). Biochar main characteristics are shown in Table 1.

Table 1. Chemical characterization of the biochars

	AP	OlvP	CP	GP	OP	TPOMW	GS	GR	RS	TC	TC+S
pH*	12.3	11.1	10.3	10.4	11.5	12.1	10.7	10.3	10.2	12.1	12.4
EC* (mS cm <sup>-1</sup> )	3.32	754x10 <sup>-3</sup>	1.45	3.23	6.33	7.75	4.52	3.13	4.43	22.8	10.07
H/C**	0.24	0.23	0.28	0.44	0.26	0.32	0.28	0.29	0.29	0.37	0.30
O/C**	0.08	0.07	0.08	0.09	0.10	0.07	0.09	0.10	0.12	0.28	0.11

AP: Almond Tree Pruning; OlvP: Olive Tree Pruning; CP: Carob Tree Pruning; GP: Grapevine Pruning; OP: Orange Tree Pruning; TPOMW: Two Phase Olive Mill Waste; GS: Grape Stalks; GR: Giant Reed; RS: Rice straw; TC: Tomato Crop; TC+S: Tomato Crop with substrate (peat). \* Water extract 1:20 w:w 25°C\*. \*\* molar ratio

#### Soil incubations

Soil incubations were performed in 250 ml polypropylene jars at 25°C and 90% of the water filled pore space (WFPS) and lasted 28 days. The control treatment consisted of 100 g of dry soil and the treatments with biochar contained 98 g of dry soil and 2 g of dry biochar. Moisture content was adjusted adding a solution of KNO<sub>3</sub> in order to apply an equivalent rate of 200 kg N ha<sup>-1</sup> (corresponding to 66 mg N kg<sup>-1</sup> based on a plough layer of 25 cm). The jars were incubated aerobically, covered with a wet cloth which allowed gas exchange and minimized evaporation. N<sub>2</sub>O samples were taken twice a day during the two first days decreasing subsequently to daily measurements

during the first two weeks, then every 3-4 days during the third week and a week after at the end of the incubation. Four replicates of each treatment were established.

## RESULTS AND DISCUSSION

N<sub>2</sub>O emissions were very low (average N<sub>2</sub>O flux ratio from 1.74 to 30.83  $\mu\text{g h}^{-1} \text{kg}^{-1}$ , depending on the treatment) despite the NO<sub>3</sub><sup>-</sup> input in all treatments. However, there was a contrasting response to biochar addition depending on its feedstock. All the pruning derived biochars (AP, OlvP, CP, GP and OP) had low H/C and O/C molar ratios and, as it was expected, N<sub>2</sub>O release was lower when this type of biochar was added to the soil. However, this consistent result was not found with the rest of biochars derived from herbaceous and secondary wastes. In the latest, N<sub>2</sub>O-N cumulative emissions ranged from a 46.61% decrease in TC treatment to a 702.63% increase in the case of RS addition.

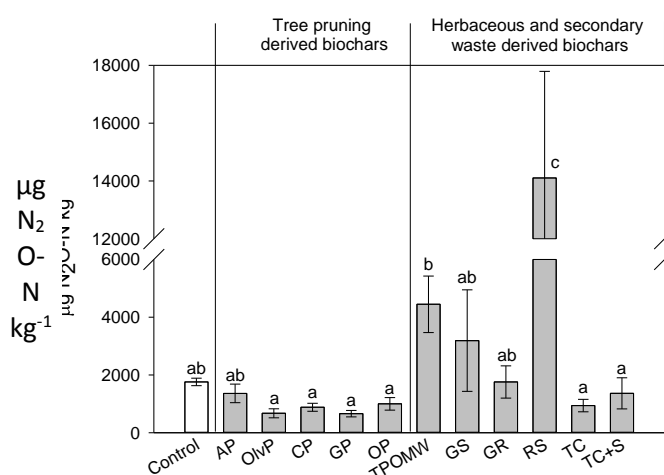

Figure 1. Soil cumulative N<sub>2</sub>O-N emissions. Error bars indicate standard deviation (n=4). Letters indicate significant differences between treatments according to Tukey's method ( $\alpha=0.05$ ). AP: Almond Tree Pruning; OlvP: Olive Tree Pruning; CP: Carob Tree Pruning; GP: Grapevine Pruning; OP: Orange Tree Pruning; TPOMW: Two Phase Olive Mill Waste; GS: Grape Stalks; GR: Giant Reed; RS: Rice straw; TC: Tomato Crop; TC+S: Tomato Crop with substrate (peat).

## CONCLUSION

Consistently with previous results found in the scientific literature, biochars obtained from the pyrolysis of tree pruning at 600°C mitigated N<sub>2</sub>O-N emissions from this soil. However, biochars obtained from other feedstocks had a contrasting impact on N<sub>2</sub>O emissions being their H/C and O/C molar ratios of no value in predicting their mitigation potential. Our results indicate that adequate indicators of biochar capacity in reducing N<sub>2</sub>O emissions remain hard to define when feedstock sources are different to those derived from tree pruning.

**Acknowledgements:** This study was funded by Funded by the Regional Agency of Science and Technology from Murcia (ref. 19281/PI/14).

## REFERENCES

- Cayuela, M. L., Van Zwieten, L., Singh, B. P., Jeffery, S., Roig, A., Sánchez-Monedero, M. A. ,2014. Biochar's role in mitigating soil nitrous oxide emissions: A review and meta-analysis. *Agriculture, Ecosystems & Environment*, 191, 5-16.
- Cayuela, M. L., Jeffery, S., Van Zwieten, L., 2015. The molar H: Corg ratio of biochar is a key factor in mitigating N<sub>2</sub>O emissions from soil. *Agriculture, Ecosystems & Environment*, 202, 135-138.
- Downie, A., 2011. Biochar production and use: environmental risks and rewards. PhD Thesis, University of South Wales.
- Spokas, K. A.,2010. Review of the stability of biochar in soils: predictability of O: C molar ratios. *Carbon Management*, 1(2), 289-303.

**N<sub>2</sub>O EMISSION DURING SUGARCANE CULTIVATION WITH DIFFERENT LEVELS OF STRAW REMOVAL**GIACOMINI, S. J.<sup>1</sup>, PINHEIRO, P. L.<sup>1</sup>, DIETRICH, G.<sup>1</sup>, RECOUS, S.<sup>2</sup>, POLLET, C. S.<sup>1</sup>, BICK, R. A.<sup>1</sup><sup>1</sup> Federal University of Santa Maria, Santa Maria, Brazil; <sup>2</sup> INRA - UMR FARE, Reims, France**INTRODUCTION**

Brazil is the world's largest producer of sugarcane with a cultivated area of 8.74 million hectares in 2017. Currently about 90% of this area is managed in the green cane trash blanketing system (GCTB), in which straw (called trash) is left as mulch on the soil surface. The persistence of this residue (7.4 to 24.3 Mg ha<sup>-1</sup>) on the soil can increase N<sub>2</sub>O emissions by affecting the nitrification and denitrification processes due to the high C contribution and the maintenance of higher soil moisture values combined with the use of nitrogen fertilization (Butterbach-Bahl et al., 2013). With the advent of second generation ethanol produced from biomass, there is the possibility of partial or total removal of sugarcane straw for this purpose. However, little is known about the impact of straw removal on N<sub>2</sub>O emissions from soil to the atmosphere. Therefore, the objective of our work was to determine soil N<sub>2</sub>O emissions after mechanized harvest at different levels of straw removal before and after nitrogen fertilization.

**MATERIAL AND METHODS**

The study was conducted at the Federal University of Santa Maria in the state of Rio Grande do Sul, Brazil. The experiment was carried out in the first ratoon sugarcane (2015/16) during 365 days. The experimental design was of randomized blocks in a factorial scheme 4x2 with four replicates. The first factor was four straw levels: 0, 4, 8 and 12 Mg ha<sup>-1</sup> (100, 67, 33 and 0% removal). The second factor was two doses of urea-N: 0 and 100 kg ha<sup>-1</sup>. The urea-N was applied in a single dose on the soil surface or on the straw 52 days after the harvest of plant cane. Soil-surface N<sub>2</sub>O fluxes were measured between 09:00 and 11:00 hours from treatment application to harvest of sugarcane (365 days) using insulated, fan-mixed, non-flow-through and non-steady-state chambers (70 cm length, 40 cm width and 20 cm height). Measurements were made two to three times per week during the first month following straw and urea applications and less frequently thereafter. Prior to straw application, one galvanized steel base per plot was placed perpendicular to a cane row and inserted into the soil (5 cm). The bases were left in place for the duration of the measurement period. During chamber deployment, air samples were taken at 18-min intervals (t<sub>0</sub>, t<sub>18</sub> and t<sub>36</sub>) using a 20-mL polypropylene syringe fitted with a three-way stopcock and immediately transferred to 12-mL pre-evacuated glass vials. Air samples were analyzed for N<sub>2</sub>O concentration within 7d using a gas chromatograph (GC-2014, Shimadzu Corp.) equipped with an electron capture detector. The N<sub>2</sub>O flux (μg N<sub>2</sub>O m<sup>-2</sup> h<sup>-1</sup>) and cumulative N<sub>2</sub>O emission (g N-N<sub>2</sub>O ha<sup>-1</sup>) was calculated according to the equation described by Aita et al. (2014). The N<sub>2</sub>O-N emission factors (EF) were calculated according IPCC (2006). All data were submitted to analysis of variance (ANOVA) and the means of each treatment were compared by the LSD test at the 5% probability level. For the cumulative N<sub>2</sub>O emission at the different levels of straw a linear regression was fitted.

**RESULTS AND DISCUSSION**

N<sub>2</sub>O fluxes increased mainly at two periods and were associated with rainfall: after addition of straw on the soil surface and after N fertilization. In the treatments without N, N<sub>2</sub>O fluxes were higher in the presence of straw (4S, 8S and 12S) than without straw (0S) until 65 days. After, N<sub>2</sub>O fluxes returned to basal level (Figure 1b). In fertilizer N treatments, the highest N<sub>2</sub>O fluxes occurred between 11 and 22 days after urea-N application in the 8S+N and 12S+N treatments (68.3 to 99.1 μg N<sub>2</sub>O-N m<sup>-2</sup> h<sup>-1</sup>). After 120 days N<sub>2</sub>O fluxes returned to basal level (Figure 1b). The cumulative emission of N<sub>2</sub>O did not differ between treatments in the period before N application. On average, the amount of N<sub>2</sub>O emitted in that period represented 35.4 and 46.9% of the annual emission of the treatments with and without N, respectively. There was no interaction between straw levels and N. The difference in cumulative N<sub>2</sub>O emitted between treatments with and without N at each level of straw was directly related to

the amount of straw at the soil surface, ranging from 519.3 (0S) to 759.1 (12S) g N<sub>2</sub>O-N ha<sup>-1</sup> ( $y = 512.4 + 20.2 * x$ ,  $R^2 = 0.99$ ). EF for urea-N varied from 0.11 (0S) to 0.24% (12S) and increased with lower removal rate of the straw ( $y = 0.11 + 0.01 * x$ ,  $R^2 = 0.97$ ). On average for the four straw levels, N fertilization increased the N<sub>2</sub>O emission by 32.5% (712.6 vs 537.6 g N<sub>2</sub>O-N ha<sup>-1</sup>) compared to without N. The straw on soil surface influences soil moisture, temperature and availability of soluble C in the soil, which may favor the formation of anaerobic conditions and occurrence of the denitrification process, one of the main processes responsible for the emission of N<sub>2</sub>O in the soil (Butterbach-Bahl et al., 2013).

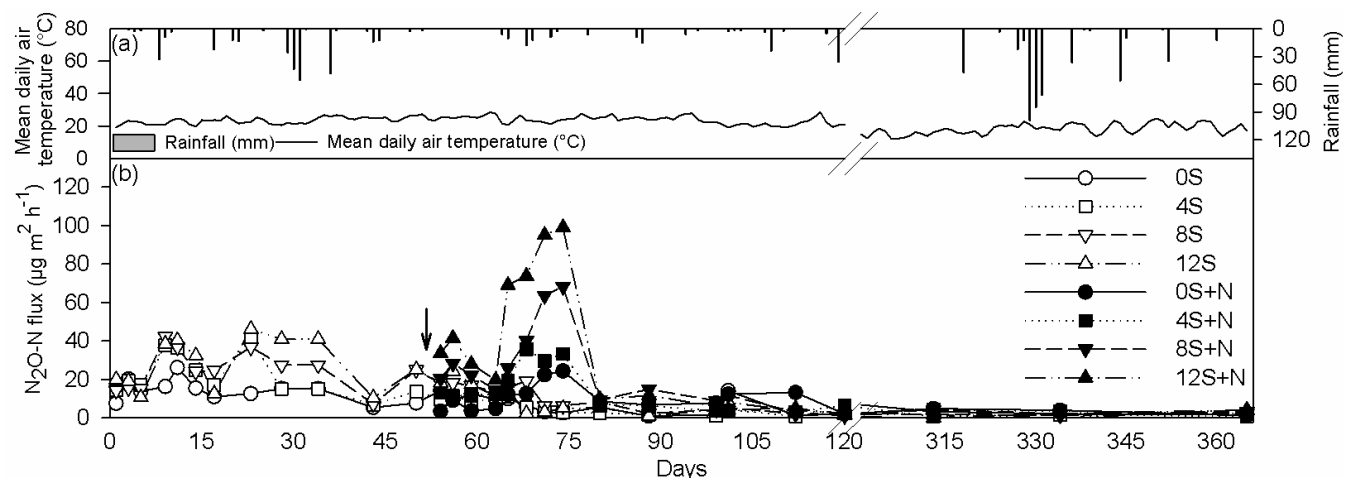

Figure 1. Mean daily air temperature and rainfall (a) and N<sub>2</sub>O-N flux (b) in the first ratoon sugarcane after 100 kg urea-N ha<sup>-1</sup> (N) application over the different straw (S) rates (0, 4, 8 e 12 Mg ha<sup>-1</sup>). Arrow indicates urea-N application.

## CONCLUSION

Despite the various benefits that permanence of the straw generates to the soil and the plant, it is observed that the maintenance of the straw associated with N fertilization can provide favorable conditions for N<sub>2</sub>O emission.

**Acknowledgements:** EMBRAPA-PETROBRAS, CAPES and CNPq.

## REFERENCES

- Aita C., Gonzatto R., Miola E.C.C., Santos D. B. dos, Rochette P., Angers D. A., Chantigny M.H., Pujol S.B., Giacomini D.A., Giacomini S.J., 2014. Injection of dicyandiamide-treated pig slurry reduced ammonia volatilization without enhancing soil nitrous oxide emissions from no-till corn in southern Brazil. *J Environ Qual.* 789-800.
- Butterbach-Bahl K., Baggs E.M., Dannenmann M., Kiese R., Zechmeister-Boltenstern S., 2013. Nitrous oxide emissions from soils: how well do we understand the processes and their controls? *Philos T Roy Soc B.* 368.
- IPCC, 2006. Guidelines for National Greenhouse Gas Inventories. Vol. 4. Agriculture, Forestry and Other Land Use. Prepared by the National Greenhouse Gas Inventories Program (eds Eggleston HS, Buendia L, Miwa K, Ngara T, Tanabe K), pp. 5.1–5.50. IGES, Hayama, Kanagawa

## AMMONIA LOSS FROM UREA AND CALCIUM AMMONIUM NITRATE AFTER APPLICATION TO WINTER WHEAT AND WINTER OILSEED RAPE

SPOTT, O., KREUTER, T., SCHUSTER, C.

SKW Stickstoffwerke Piesteritz GmbH, Department Research and Development, Möllendorfer Strasse 13, 06886 Wittenberg, Germany

### INTRODUCTION

Ammonia ( $\text{NH}_3$ ) loss after fertilization of mineral nitrogen (N) is well known for its detrimental effect regarding N use efficiency and related ecological issues. The present study aimed at evaluating mean  $\text{NH}_3$  loss after urea as well as calcium ammonium nitrate fertilization under practice-related field conditions and focused in particular on the  $\text{NH}_3$  mitigation potential by the application of a urease inhibitor along with urea.

### MATERIAL AND METHODS

Since 2013,  $\text{NH}_3$  emission measurements after N fertilization in winter wheat (WW / 2013 & 2014) and winter oilseed rape (WOR / 2015 & 2016) have been conducted over 4 years. Analyses of  $\text{NH}_3$  fluxes as well as calculation of related cumulative N losses were based on the Calibrated Passive Sampling method (CPS) as described in detail by Pacholski (2016). The CPS approach was shown to deliver reliable results for broadcast application of mineral fertilizers in comparison to e.g. (i) passive flux sampling approaches with a backward Lagrangian stochastic dispersion flux model as well as (ii) the dynamic model Volt'Air' (Kang et al., 2015; Pacholski et al., 2017). Field experiments have been conducted at the Agricultural Experimental Station Cunnernsdorf in Central Germany (51°22'N, 12°33'E; 130 m a.s.l.;  $\varnothing$  9.1°C;  $\varnothing$  620 mm; Podzoluvisols; sandy loam, pH 6.5,  $C_{\text{org}}$  1.1%,  $N_t$  0.12%).  $\text{NH}_3$  emissions were measured in randomized field plots (size 9 x 9 m with 9 x 9 m interspace; n=4) including an unfertilized control. In total, five different N fertilizers were tested: calcium ammonium nitrate (CAN), granular urea (U), granular urea with a urease inhibitor (U+UI), granular urea with a nitrification inhibitor (U+NI), and granular urea with a urease- and nitrification inhibitor (U+UI+NI). Fertilizers were compared by their relative  $\text{NH}_3$  loss (% of applied N). Here we present only U, U+UI+NI and CAN. In the case of WW, fertilizers were applied in three (CAN, U) and two (U+UI+NI) split applications per year, respectively. For WOR they were applied in two (CAN, U) split applications per year and only once a year (U+UI+NI), respectively. The total number of applications is reduced by one when a nitrification inhibitor is added to the fertilizer (i.e. U+UI+NI). Total N input was 220 kg N ha yr<sup>-1</sup> in WW and 180 kg N ha yr<sup>-1</sup> in WOR.

### RESULTS AND DISCUSSION

Over four years of practice-related fertilizer application to WW (2013 & 2014) and WOR (2015 & 2016) measured average total N loss via  $\text{NH}_3$  was 7.0% for U, 2.6% for U+UI+NI and 0.6% for CAN, respectively (Fig. 1A). Consequently, the mean  $\text{NH}_3$  loss for urea has been below the current European emission factor for Germany (close to 15%; Pacholski et al., 2017). It was additionally reduced by approx. 63% on average when a UI was applied concomitantly. As in principle expected, CAN was generally less susceptible to  $\text{NH}_3$  loss (always < 1% of fertilized N), since no increase in soil pH takes place after its application to soil as is the case for urea during its hydrolysis (Sommer et al., 2004). Significant differences were found with respect to fertilized plant species and related  $\text{NH}_3$  loss, in particular in the case of urea application (Fig. 1A). While in WW  $\text{NH}_3$  loss of U was on average 12.3% (2013: 13.1% / 2014: 11.5%) of fertilized N, in WOR only 0.6% (2015: 0.6% / 2016: 0.6%) of applied urea-N was emitted as  $\text{NH}_3$ . A similar trend was also found for U+UI+NI, where in WW 4.6% (2013: 2.1% / 2014: 7.2%) and in WOR 0.2% (2015: 0.2% / 2016: 0.1%) was emitted on average. Even if less pronounced, CAN also revealed a weak trend for higher  $\text{NH}_3$  emissions when applied to WW (2013: 0.9% / 2014: 1.0%) in comparison to WOR (2015: 0.0% / 2016: 0.3%). As reported by e.g. Rogers & Aneja (1980) plants are differently suited to take up  $\text{NH}_3$  directly from the surrounding atmosphere and thus, the plant species currently fertilized may have an impact on total  $\text{NH}_3$  loss after fertilization. It remains, however, rather questionable if large differences as found here can be explained by different  $\text{NH}_3$  uptake capacities of cropped plants. Besides plant physiology effects as well as typical soil

characteristics such as pH and cation exchange capacity, the weather conditions during as well as after fertilization are also well known as a key driver of  $\text{NH}_3$  loss (e.g. Sommer et al., 2004). This mainly relates to soil temperature and soil moisture conditions (i.e. precipitation and soil water dynamic). While the latter largely affects the distribution of a fertilizer within the soil, the former directly controls the equilibrium between  $\text{NH}_4^+$  and  $\text{NH}_3$  within the soil solution. As a main consequence  $\text{NH}_3$  loss potential is significantly decreased if a fertilizer is washed into the soil soon after its application. On the other hand,  $\text{NH}_3$  loss potential is significantly increased by a rising soil temperature due to the resulting increase in  $\text{NH}_3$  concentration in the soil solution (to the detriment of  $\text{NH}_4^+$ ) and thus, an increased  $\text{NH}_3$  emission gradient towards the atmosphere.

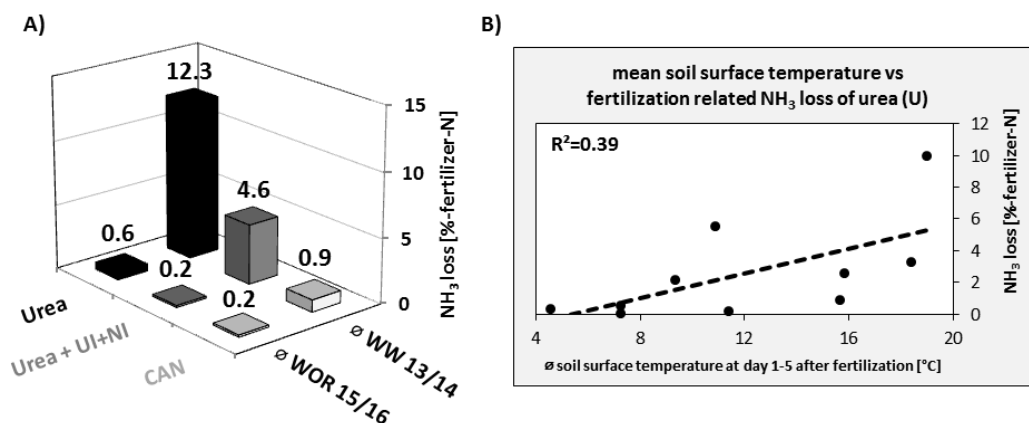

Figure 1 (A) Average of total cumulative  $\text{NH}_3$  loss after fertilization of U, U+UI+NI and CAN to winter wheat (WW 2013 & 2014) and winter oilseed rape (WOR 2015 & 2016), respectively, and (B) impact of seasonal weather conditions (visualized by the mean soil surface temperature of day 1 to 5 after fertilizer application) on  $\text{NH}_3$  loss potential after a fertilization event (cumulative  $\text{NH}_3$  loss after each single fertilization event of urea during the field campaign 2013 to 2016).

Considering that the practice-related fertilization strategy of WW differs clearly from that of WOR, it appears rather likely that observed  $\text{NH}_3$  loss related to WW and WOR was in fact provoked by the prevailing weather conditions during fertilization. While WOR is fertilized under largely cold and wet conditions (end of winter to early spring), WW is fertilized later on from spring to early summer under progressively warmer and dryer conditions. Consequently,  $\text{NH}_3$  loss potential could be assumed to generally increase from end of winter to early summer (March to June) in the course of season-related changes of temperature and/or moisture conditions. There was a weak trend of an increasing  $\text{NH}_3$  loss potential in relation to soil surface temperature after fertilization of urea (Fig. 1B). Even if it is currently not provable as statistically significant due to the multifactorial complexity of  $\text{NH}_3$  soil release as well as the limited number of annual data sets, it underlines the fundamental impact of seasonal weather conditions during mineral fertilization of e.g. WOR on the one hand and WW on the other.

## CONCLUSION

Present results clearly demonstrate that a uniform  $\text{NH}_3$  emission factor appears to be insufficient to represent  $\text{NH}_3$  losses due to practice-related fertilization, in particular with respect to urea. Crop type and related fertilization strategy (i.e. season and number of application) have to be considered to optimize the estimation of soil  $\text{NH}_3$  loss by mineral fertilizer application. The mean  $\text{NH}_3$  loss of 7.0% fertilizer-N found for urea is lower than currently assumed and hence, challenges the latest European emission factor of approx. 15% as also recently reported by Pacholski et al. (2017). The application of a urease inhibitor significantly reduces  $\text{NH}_3$  release after urea fertilization by more than 50% independent from crop type and related fertilization strategy.

## REFERENCES

Kang N., Köster J.R., Seidel A., Pacholski A., 2015. Field measurement of ammonia emissions after nitrogen



- fertilization - A comparison between micrometeorological and chamber methods. *European Journal of Agronomy*, 71, 115-122.
- Pacholski A., 2016. Calibrated Passive Sampling - Multi-plot field measurements of NH<sub>3</sub> emissions with a combination of dynamic tube method and passive samplers. *Journal of Visualized Experiments* 109, 1-15.
- Pacholski A., Doehler J., Schmidhalter U., Kreuter T., 2017. Scenario modeling of ammonia emissions from surface applied urea under temperate conditions: application effects and model comparison. *Nutrient Cycling in Agroecosystems*, 110 (1), 177-193.
- Rogers H.H., Aneja V.P., 1980. Uptake of atmosphere ammonia by selected plant species. *Environmental and Experimental Botany*, 20, 251-257.
- Sommer S.G., Schjoerring J.K., Denmead O.T., 2004. Ammonia emission from mineral fertilizers and fertilized crops. *Advances in Agronomy*, 82, 557-622.

## A COMPARISON OF THE NITROGEN USE EFFICIENCY AND NITROGEN LOSSES ATTRIBUTED TO THREE FERTILISER TYPES APPLIED TO AN INTENSIVELY MANAGED SILAGE CROP

COWAN N<sup>1</sup>., LEVY P<sup>1</sup>., MORING A<sup>1</sup>., LOUBET B<sup>2</sup>., POLINA VOYLOKOV P<sup>2</sup>., SKIBA U<sup>1</sup>

<sup>1</sup> Centre for Ecology and Hydrology, UK; <sup>2</sup> INRA, France

### INTRODUCTION

A constant supply of reactive nitrogen (Nr) is required to sustain high crop productivity in intensively managed agricultural soils; however, the nutrient use efficiency (NUE) of these crops is frequently low, with more than half of applied Nr typically being lost to the environment through biological pathways and chemical processes such as the emission of ammonia (NH<sub>3</sub>) and nitrous oxide (N<sub>2</sub>O). One method of reducing Nr losses from agriculture is the incorporation of microbial inhibitors with fertiliser application which directly target and slow a specific biological pathway. Synthetic fertilisers (typically urea) coated with chemical inhibitors that target urease hydrolysis and microbial nitrification have been shown to reduce Nr losses to some extent in lab conditions and several have been trialed at the field scale with varying results. Although there are many positive studies which promote the pollution reducing capabilities of these chemicals, some questions remain over the overall effectiveness of the inhibitors which face claims that reduction of one form of Nr pollution may contribute to another. The use of inhibitors in farming still remains uncommon, mostly due to a reluctance to change to an uncertain practice, compounded by the drawback that treated fertilisers are typically more expensive than traditionally used products, and that yields may be reduced. This study aims to specifically investigate the effect of the agrotain<sup>®</sup> urease inhibitor on a typical grassland silage crop in Scotland, comparing yield and Nr losses in the form of N<sub>2</sub>O and NH<sub>3</sub> with the two most commonly used synthetic nitrogen fertilisers in the UK: ammonium nitrate (nitram) and urea.

### MATERIAL AND METHODS

A grassland field which had historically been used to graze sheep at Easter Bush Farm Estate (Scotland) was selected for the field trial. A grid of 16 plots, each measuring 20 m by 20 m, were marked out and randomly assigned one of four different treatments (Figure 1). Fertilisers in the form of nitram, urea and agrotain<sup>®</sup> coated urea were applied at a rate of 70 kg-N ha<sup>-1</sup> to the plots a total of five times over the space of two years (2016-2017).

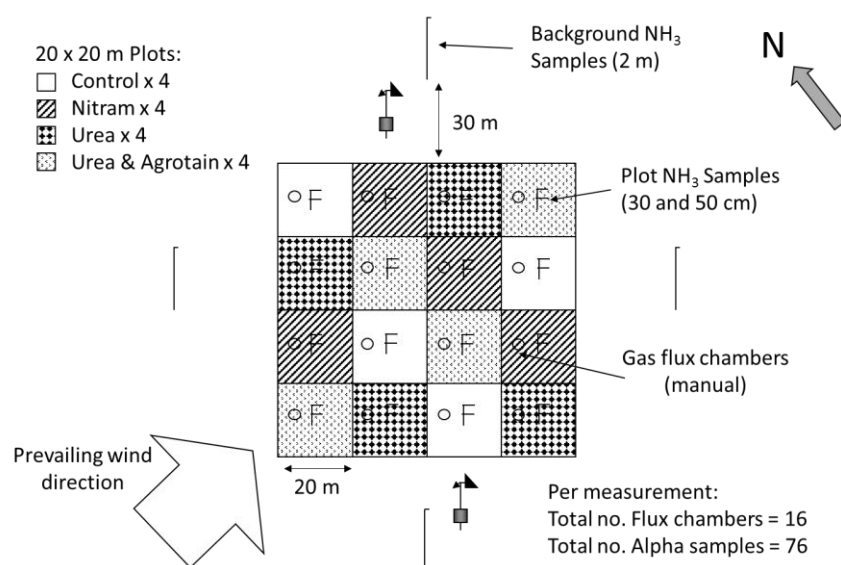

Figure 1. Field site layout describing measurement locations of N<sub>2</sub>O flux chambers and NH<sub>3</sub> sample badges.

The plots were arranged in such a way to allow the use of the Flux Interpretation by Dispersion and Exchange over Short Range (FIDES) method; an inverse modelling approach which infers NH<sub>3</sub> emissions from multiple small areas using multiple passive (Alpha) samplers (Loubet et al., 2017). NH<sub>3</sub> fluxes were measured for three events only. Static chambers were used to measure N<sub>2</sub>O fluxes over all five events. Cumulative fluxes of N<sub>2</sub>O were calculated using a Bayesian approach which takes into account the log-normal nature of spatial and temporal variability of N<sub>2</sub>O emissions (Levy et al., 2017). A 30 m<sup>2</sup> section of the silage grass (1.5 by 20 m) was harvested using a Haldrup harvester (Haldrup F-55) with on-board weighing capabilities for yield measurements.

## RESULTS AND DISCUSSION

The nitram fertilizer performed best in terms of yield across the five replications with the mean NUE approximately 40 % higher than that of the other urea based fertilisers, though large uncertainties were present due to spatial and seasonal variation. The negative environmental impact of nitram application was highlighted in the comparison of N<sub>2</sub>O fluxes, for which nitram lost significantly more of the Nr applied than the urea fertilisers. Losses of applied Nr in the form of NH<sub>3</sub> were highest for the uncoated urea fertilizer, reaching into double figures while losses for nitram were negligible and emissions from the treated urea remained low (Table 1).

Table 1. Summary of the fate of applied Nr in terms of yield uptake, NH<sub>3</sub> and N<sub>2</sub>O emissions for all Nr applications.

N fertiliser type	Yield % NUE	NH <sub>3</sub> % N Loss	N <sub>2</sub> O % N Loss
Nitram	<b>35.2 ± 21.6</b>	-0.3 ± 1.3	<b>1.9 ± 1.3</b>
Urea	20.5 ± 19.9	<b>13.6 ± 3.6</b>	0.6 ± 0.3
Urea & agrotain®	23.8 ± 23.3	1.4 ± 1.5	0.7 ± 0.4

## CONCLUSION

This experiment confirms past studies which have identified urea as a large source of NH<sub>3</sub> emission and ammonium nitrate as a large source of N<sub>2</sub>O emissions. The Agrotain® treated urea emitted significantly less NH<sub>3</sub> when compared to urea and had a negligible effect on N<sub>2</sub>O emissions; however, this decrease in Nr loss was not translated into a significant increase in crop yield. The results of this study suggest that urease inhibitors, such as Agrotain®, may play an important role in mitigating Nr pollution, however the agronomic benefits to the farmer appear to be negligible. Our experiments are short term only and there is a need for more long-term studies covering different climate zones, crop types and soil properties to investigate the economic and environmental benefits of switching from the preferred ammonium nitrate fertilisers in the UK.

**Acknowledgements:** We gratefully acknowledge funding of the BBSRC – Newton project ‘UK-China Virtual Joint Centre for Improved Nitrogen Agronomy (CINAG)’

## REFERENCES

- Loubet, B., Carozzi, M., Voylokov, P., Cohan, J.P., Trochard, R., and Générmon, S., 2017, Evaluation of a new inference method for estimating ammonia volatilisation from multiple agronomic plots. Biogeosciences Discuss., <https://doi.org/10.5194/bg-2017-424>
- Levy, P. E., Cowan, N., van Oijen, M., Famulari, D., Drewer, J. and Skiba, U., 2017, Estimation of cumulative fluxes of nitrous oxide: uncertainty in temporal upscaling and emission factors. Eur J Soil Sci, 68: 400–411. doi:10.1111/ejss.12432

## NITROGEN USE EFFICIENCY OF RAW AND ANAEROBICALLY DIGESTED SLURRIES: A FIELD STUDY WITH DIFFERENT <sup>15</sup>N METHODS

HUTTER, M.<sup>1,2</sup>, KREBS, R.<sup>1</sup>, MAYER, J.<sup>2</sup>

<sup>1</sup> Zurich University of Applied Sciences ZHAW, 8820 Wädenswil, Switzerland; <sup>2</sup> Agroscope, Zürich, Switzerland

### INTRODUCTION

In agricultural biogas plants in Switzerland, in general 80 % or more of the digested organic matter is farmyard manure. Additional organic waste materials are used as co-substrates. Manure and slurry are valuable fertilisers, whereby a high nitrogen use efficiency (NUE) is important for agricultural productivity. Short-term nitrogen recovery by crops from slurries is influenced mainly by the NH<sub>4</sub>-N content, the C:N ratio and the stability of the organic substance (Gutser et al., 2005). Compared to raw slurries, anaerobically digested (AD) slurries contain less easily available organic carbon, they have a smaller C:N ratio and a wider N<sub>NH<sub>4</sub></sub>:total N ratio. In pot trials, NUE of AD was 10 to 25% higher compared to undigested slurries (Bosshard et al., 2010; de Boer, 2008). Under field conditions, results vary. Bosshard et al. (2010) found in wheat an apparent NUE of 37% when fertilised with raw and 56% with AD pig slurry. Möller et al. (2008) could find a significant effect of AD on N uptake compared to undigested slurry when slurry was incorporated into the soil shortly after application. The aim of this field study with silage maize was i) to prove whether the nitrogen use efficiency of AD slurries is higher than that of raw slurries in the year of application and ii) to compare a <sup>15</sup>N direct method (<sup>15</sup>N labelling of the slurry NH<sub>4</sub>-N fraction) with an indirect <sup>15</sup>N isotope dilution method.

### MATERIAL AND METHODS

The field trial was carried out as a fully randomized block design with four replicates in 2015 with silage maize on a luvisol with sandy loam (Zurich, Switzerland). A raw cattle slurry (RawC) and a raw pig slurry (RawP) were compared with three AD slurries from agricultural biogas plants, each of it using one of the quantitatively most important co-substrates in Switzerland: residues from cereal production (ADCe), coffee ground (ADCo) or vegetable and fruit wastes (ADVeg). One control was fertilised with synthetic mineral nitrogen (CoMin) and a second control was unfertilised (CoNull). The apparent nitrogen use efficiency (NUE), based on above-ground biomass of silage maize, was studied with two <sup>15</sup>N tracer methods. For the direct method, the slurry was labelled with (<sup>15</sup>NH<sub>4</sub>)<sub>2</sub>SO<sub>4</sub> (95 atm % <sup>15</sup>N). NUE is related to the NH<sub>4</sub>-N fraction of the slurry. For the indirect <sup>15</sup>N isotope dilution method, <sup>15</sup>N labelled clover-grass residues were ground and incorporated as a powder into the soil 32 days before sowing. In this case, slurry was not labelled. NUE calculation based on the dilution in the labelled soil pool compared to the unfertilised control and NUE refers to total-N. The plot size was 4 m<sup>2</sup>, but tracers were applied on a microplot of 1 m<sup>2</sup> grown with 8 maize plants. Results of <sup>15</sup>N methods were compared with a difference calculation, where the difference in the N uptake with and without slurry application is related to the amount of total N fertilised. From every microplot two maize plants were harvested in September, as well as two plants from the neighbouring row which was not <sup>15</sup>N labelled. Differences were analysed by analysis of variance (ANOVA), following by Tukey's honestly significant difference (HSD) test using R, version 3.0.3 and RStudio open source edition. Significance was concluded in all tests if *P*<0.05.

### RESULTS AND DISCUSSION

In difference calculation, related to total N, both raw slurries had significantly lower NUE than AD slurry ADCe and a tendentially lower NUE than ADCo (Fig. 1A). A similar pattern between treatments could be found for the NUE of the NH<sub>4</sub>-N fraction, determined with the <sup>15</sup>N direct method (Fig. 1B): Raw slurries had significantly lower NUE than AD slurries ADCo and ADCe (significant difference between RawP and ADCo). NUE of ADVeg was between raw slurries and ADCo and ADCe, respectively. Using the <sup>15</sup>N isotope dilution method, no differences between treatments could be found. Variation of the data was much larger compared with the two other methods and patterns between treatments were clearly differing (results not shown). One reason for a higher data variation in

the isotope dilution approach might be that the differences between isotopic signatures of maize in slurry fertilized plots compared to the control are smaller and thus cross contaminations and measurement errors have greater effects compared to the direct method. In addition, labelling of the soil 62 days before first fertiliser application appears to be too short to label soil organic nitrogen homogeneously.

Apparent NUE was relatively low in all treatments. The extraordinarily dry and hot weather in 2015 has probably lead to this low NUE. The two raw slurries had the lowest, the two AD slurries ADCe and ADCo the highest NUE. Bosshard et al. (2010) found comparable NUE in a field study with different calculation with 37% NUE in raw and 56% NUE in AD pig slurry, respectively. The lower NUE of ADVeg compared to ADCo and ADCe could neither be explained with the C:N ratio, nor with the  $\text{NH}_4\text{-N}$  proportion. However, ADVeg was fermented only for 14 days, which is relatively short. This could have lead to a higher amount of easily degradable C compounds and therefore to a greater slurry N immobilisation in soil.

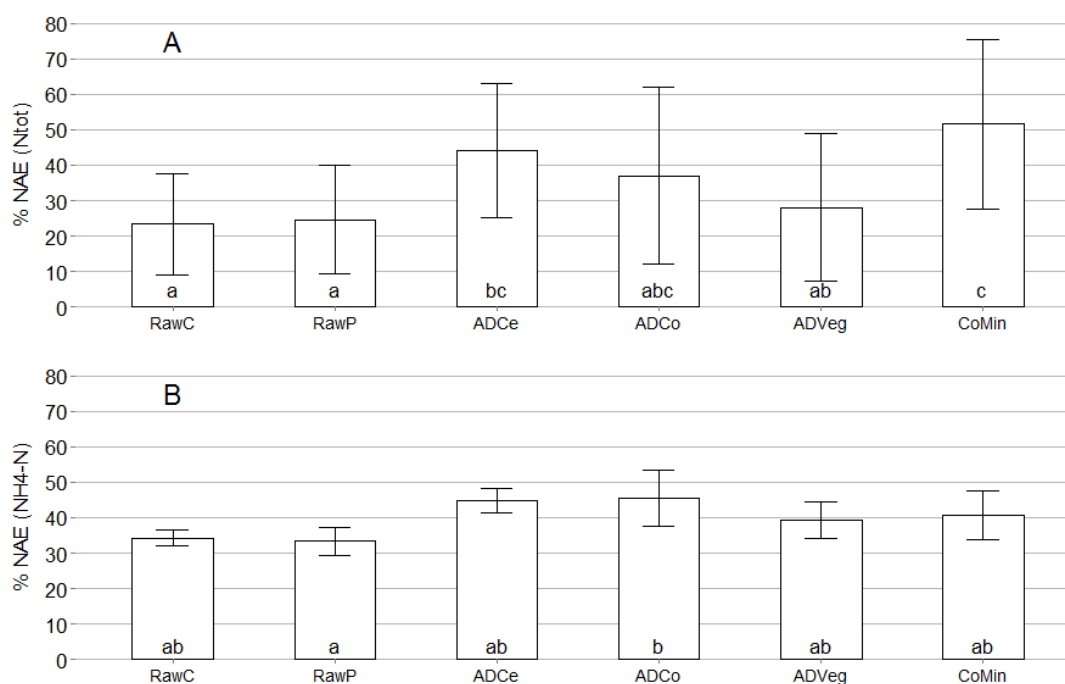

Figure 1. Nitrogen use efficiency (NUE) of raw and digested slurries calculated on the basis of above ground N uptake of mature silage maize by difference (A) and with the  $^{15}\text{N}$  direct method (B). NUE is related to total N (A) and  $\text{NH}_4\text{-N}$  (B), respectively. Different letters show significant differences between treatment means (Tuckey HSD;  $p \leq 0.05$ ). RawC: raw cattle slurry, RawP: raw pig slurry, ADCe: anaerobically digested (AD) slurry with cereal residues, ADCo: AD slurry with coffee ground, ADVeg: AD slurry with vegetables, CoMin: minerally fertilised control.

## CONCLUSION

Anaerobically digested slurry with co-substrates had a (tendentially) higher NUE compared to raw slurries in the year of application. The isotope dilution method would be a valuable method to estimate NUE of complex organic fertilisers, e.g. slurry, but the method requires a homogenous  $^{15}\text{N}$  labelling of the soil organic matter. The successful application of the isotope dilution method under field conditions requires further improvements.

## REFERENCES

- Bosshard, C., Flisch, R., Mayer, J., Basler, S., Hersener, J.-L., Meier, U., & Richner, W. (2010). Verbesserung der Stickstoffeffizienz von Gülle durch Aufbereitung. *Agrarforschung Schweiz*, 1(10), 378–383.
- de Boer, H. C. (2008). Co-digestion of Animal Slurry Can Increase Short-Term Nitrogen Recovery by Crops.

*Journal of Environment Quality*, 37(5), 1968–1973. <https://doi.org/10.2134/jeq2007.0594>

Gutser, R., Ebertseder, T., Weber, A., Schraml, M., & Schmidhalter, U. (2005). Short-term and residual availability of nitrogen after long-term application of organic fertilizers on arable land. *Journal of Plant Nutrition and Soil Science*, 168(4), 439–446. <https://doi.org/10.1002/jpln.200520510>

Möller, K., Stinner, W., Deuker, A., & Leithold, G. (2008). Effects of different manuring systems with and without biogas digestion on nitrogen cycle and crop yield in mixed organic dairy farming systems. *Nutrient Cycling in Agroecosystems*, 82(3), 209–232. <https://doi.org/10.1007/s10705-008-9196-9>

## INTERACTIVE EFFECTS OF THE FACTORS CONTROLLING URINE-N<sub>2</sub>O EMISSIONS FROM AN UPLAND SOIL

CHARTERIS, A.F.<sup>1</sup>, MARSDEN, K.A.<sup>2</sup>, CASTELLANO-HINOJOSA, A.<sup>3</sup>, LOICK, N.<sup>1</sup>, CHADWICK, D.R.<sup>2</sup>, RAVELLA, S.R.<sup>4</sup>, MEAD, A.<sup>1</sup>, FIELD, N.<sup>1</sup>, WHELAN, M.<sup>5</sup>, CÁRDENAS, L.M.<sup>1</sup>

<sup>1</sup> Rothamsted Research, UK; <sup>2</sup> School of Environment, Natural Resources and Geography, Bangor University, UK; <sup>3</sup> Department of Microbiology, University of Granada, Spain; <sup>4</sup> Institute of Biological and Environmental and Rural Sciences (IBERS), Aberystwyth University, UK; <sup>5</sup> Department of Geography, University of Leicester, UK

### INTRODUCTION

Agriculture accounted for almost 70% of the UK's N<sub>2</sub>O emissions in 2015 (Brown et al., 2017). The contribution of grasslands to these emissions has large uncertainty, partly due to their heterogeneous nature and the uneven distribution of animal excreta and treading. Emissions from upland pastures, important for sheep farming, are particularly understudied and uncertainty is increased by the lack of UK-specific emission factors (EFs) for grazing returns of sheep excreta (Brown et al., 2017). Urine patches represent important temporary point sources of pasture N<sub>2</sub>O emissions in which labile urine-C and N stimulate soil N cycling (Cardenas et al., 2016). The main processes responsible for N<sub>2</sub>O production are nitrification (aerobic) and denitrification (anaerobic). These processes are influenced by other soil conditions (e.g. pH), and any factors affecting them, including patch location (e.g. in relation to farmland features), pasture management and weather, as well as the concentration, composition and volume of the urine deposited (Dijkstra et al., 2013; Marsden et al., 2016). The interaction of these factors, varying in space and over time, make aggregated N<sub>2</sub>O emission estimates uncertain. The laboratory experiments conducted in this study aim to investigate the interactive effects of factors affecting sheep urine-derived N<sub>2</sub>O emissions from an upland soil. Data will be used in field-scale models of upland N<sub>2</sub>O emissions which integrate the spatial and temporal variability of sheep diet and behaviour, urine deposition characteristics, topography and soil physico-chemical properties to generate better N<sub>2</sub>O emission estimates.

### MATERIAL AND METHODS

#### Site and sampling

Soil was sampled from an 11.5 ha semi-improved upland pasture (ca. 240-340 m above sea level) at Bangor University's Henfaes Research Centre (Abergywnnregyn, North Wales). The pasture is dominated by grasses (British NVC classifications U4 and MG6) and bracken (*Pteridium aquilinum*) on a podzolic soil, with spatial differences due to organic residues building up beneath bracken dominated areas. Representative bulked samples of 'grass' soil and of 'bracken' soil were generated by sampling 42 points identified across the site. Urine was sampled from six Welsh Mountain ewes (*Ovis aries*). It was stored filtered and frozen until required, upon which a homogenized sample was generated at 14 g N l<sup>-1</sup> for use or appropriate dilution for the experimental treatments.

#### Experimental design

Incubation experiments to determine N<sub>2</sub>O fluxes were conducted in the denitrification incubation system (DENIS), a flow-through soil core incubation system which allows automated measurement of CO<sub>2</sub>, N<sub>2</sub>O, NO and N<sub>2</sub> emissions under an 80:20 He:O<sub>2</sub> atmosphere. A fractional factorial design was used to explore the interactive effects of five factors affecting urine-N<sub>2</sub>O emissions: soil type (x2), soil water-filled pore space (% WFPS; x3), urine N concentration (x4), urine volume (x2) and temperature (x2). The design considered the constraints of the DENIS (12 vessels, one temperature per incubation) and prioritized information relating to two-factor interactions. Half of the 96 possible combinations were tested over four 14-day incubations in the DENIS. Parallel destructive incubation experiments with three time-points were also conducted. A subset of the treatments will also be analyzed using the multifactorial Taguchi methodology (Ravella et al., 2008). Soil cores consisted of sieved (< 9 mm) soil, repacked into two layers reflecting the organic-rich top layer overlying mineral soil to 0.5 and 0.8 g cm<sup>-3</sup>, respectively.

### Gas and soil analyses

Out-flow gas concentrations were determined by gas chromatography-electron capture detection (CO<sub>2</sub> and N<sub>2</sub>O), gas chromatography-helium ionization detection (N<sub>2</sub>) and chemiluminescence (NO). Analysis of variance (ANOVA) was conducted on cumulative N<sub>2</sub>O emissions to assess which factors are most important in driving emissions and whether any two-factor interactions are significant. Soil samples were analysed at *t*=0, 1, 3, 8 and 14 days. Soil moisture, pH and K<sub>2</sub>SO<sub>4</sub>-extractable NH<sub>4</sub><sup>+</sup> and NO<sub>3</sub><sup>-</sup> concentrations were determined.

### RESULTS AND DISCUSSION

CO<sub>2</sub> fluxes peaked quickly following urine application and showed a similar pattern of response across all urine treatments (max. *ca.* 90 kg ha<sup>-1</sup> hr<sup>-1</sup>). NO fluxes peaked twice at low temperature, but only once in higher temperature experiments (max. *ca.* 3.5 g ha<sup>-1</sup> hr<sup>-1</sup>). Production of N<sub>2</sub> was not observed during any incubation experiment. N<sub>2</sub>O fluxes ranged from 0 to 0.23 kg ha<sup>-1</sup> hr<sup>-1</sup>, with treatments with 0 g urine-N l<sup>-1</sup> and 50% WFPS giving lower fluxes than those with higher urine N inputs and 80% WFPS. Temperature affected the shape and timing of N<sub>2</sub>O emission responses. Cumulative N<sub>2</sub>O emissions ranged from ≈0 to 0.83 kg ha<sup>-1</sup>. Increasing soil % WFPS and urine N concentration significantly increased cumulative N<sub>2</sub>O emissions (F<sub>2,16</sub>=85, *p*<0.001 and F<sub>3,16</sub>=32, *p*<0.001, respectively). Although the effect of temperature was large (*s*<sup>2</sup>=3.37, 1 d.f. vs. residual=0.08, 16 d.f.), there is insufficient statistical power to conclude it is significant. Significant two-factor interactions were revealed for % WFPS and urine N concentration (F<sub>6,16</sub>=6.7, *p*=0.001), with a larger combined effect of increases in both factors on increasing N<sub>2</sub>O emissions than each alone and for soil type and % WFPS (F<sub>2,16</sub>=4.2, *p*=0.034).

### CONCLUSION

N<sub>2</sub>O emissions from upland soils, which are often assumed to be low due to N-limitation, are not negligible when urine patches are deposited under some conditions, (e.g. when concentrated (high N) urine is deposited on wet soils) and large, transient N<sub>2</sub>O fluxes can result. These data will be used in developing a spatially and temporally explicit model of N<sub>2</sub>O emissions from upland pastures to improve the agricultural inventory of N<sub>2</sub>O. This will help in targeting mitigation efforts to highest impact areas. In addition, the results could be useful in developing simple rules for upland land owners to avoid higher N<sub>2</sub>O emissions.

**Acknowledgements:** Thanks to J. Evans for statistical support; J. Holmberg and G. Sanfratello for urine collection and assistance with soil sampling. This work was funded by the UK NERC, under grant award NE/M015351/1/.

### REFERENCES

- Brown P., Broomfield M., Cardenas L., Choudrie S., Kilroy E., Jones L., Passant N., Thomson A., Wakeling D., 2017. UK Greenhouse Gas Inventory, 1990 to 2015: Annual Report for submission under the Framework Convention on Climate Change. Didcot, Ricardo-AEA.
- Cardenas L.M., Misselbrook T.M., Hodgson C., Donovan N., Gilhespy S., Smith K.A., Dhanoa M.S., Chadwick D., 2016. Effect of the application of cattle urine with or without the nitrification inhibitor DCD, and dung on greenhouse gas emissions from a UK grassland soil, *Agr. Ecosyst. Environ.*, 235, 229-241.
- Dijkstra J., Oenema O., van Groenigen J.W., Spek J.W., van Vuuren A.M., Bannink A., 2013. Diet effects on urine composition of cattle and N<sub>2</sub>O emissions, *Animal*, 7, 292-302.
- Marsden K.A., Jones D.L., Chadwick D.R., 2016. Disentangling the effect of sheep urine patch size and N loading rate on cumulative N<sub>2</sub>O emissions, *Anim. Prod. Sci.*, 56, 265-275.
- Ravella S.R., Kumar C.G., Prakasham R.S. and Hobbs P.J., 2008. The Taguchi methodology as a statistical tool for biotechnological applications: A critical appraisal, *Biotechnol. J.*, 3, 510-523.



**OPTIMIZING NITROGEN RATE OF PEARL MILLET UNDER ARID AND SEMI-ARID ENVIRONMENTS**ULLAH, A.<sup>1,2\*</sup>, AHMAD, A.<sup>1</sup>, KHALIQ, T.<sup>1</sup> SAEED, U.<sup>3</sup> AHMAD, I.<sup>1</sup> HUSSAIN, J.<sup>1</sup> MAHMOOD, A.<sup>2</sup><sup>1</sup> Department of Agronomy, University of Agriculture, Faisalabad, Pakistan; <sup>2</sup> Ayub Agricultural Research Institute Faisalabad, Pakistan;<sup>3</sup> Action on Climate Today Lahore, Pakistan**INTRODUCTION**

The evidences for different response of pearl millet to fertilizer application have been reported in the literature with optimum rates ranging from 0 to >150 kg ha<sup>-1</sup> (Ullah et al., 2017). The form of N (NO<sub>3</sub> – N vs. NH<sub>4</sub> – N), N mode and time of application also affect the nitrogen uptake and use efficiency. The authors concluded that absorption of ammonium over nitrate may have negative effect on growth and development of millet. Spitalnaik et al. (1995) examined the N uptake at various growth phases and concluded that pearl millet utilized high N uptake of 110 kg ha<sup>-1</sup> at 4th stage (vegetative) and reached a maximum uptake of 153 kg ha<sup>-1</sup> at physiological maturity. It is examined that for everyone kilogram N applied, the hybrids or improved varieties returned 10-15 kg of grain at 30-60 kg N ha<sup>-1</sup> (Maman et al., 1999). However, 40 kg N ha<sup>-1</sup> was found to be economical for most of the millet growing regions, but the higher nitrogen applications are recommended in soil with adequate moisture. The high yielding varieties and hybrids used N more efficiently than traditional cultivars (Ullah et al., 2017). There is clear need to understand N utilization in many cereals (Gascho et al., 1995). The overall optimum N utilization for grain pearl millet in not reported earlier for pearl millet farming areas in Pakistan.

**MATERIALS AND METHODS**

Field experiments were conducted at two different locations, based on climatic conditions, the Layyah district is comprised of arid environment while Faisalabad have semi-arid conditions. Three plant spacings (10, 15 and 20 cm, main plots), and four N rates (0, 150, 200, 250 kg ha<sup>-1</sup>, subplots) were compared in split plot design with three replicates. The plot size of each sub plot was 3.6 m × 1.8 m with three replications.

Regression analysis was carried out to study the response of millet grain yield to different N levels for three intra row spacing. The quadratic equations were fitted to calculate optimum N for different plant spacing. The relationships were plotted between observed grain yield and N levels for each plant spacing to set equations. The amount of N for maximum grain yield (point of inflection) of millet was calculated for each intra row spacing using the following formula by considering x as optimum N. The response of millet grain yield to N rates (0, 150, 200, 250 kg ha<sup>-1</sup>) at different plant spacing (10, 15, 20 cm) was described with quadric response curve for each site, as in following equations (Saeed et al., 2017).

$$Y=a+bN+cN^2 \quad (1), N_{(optimum)}= (-b) / 2(a) \quad (2)$$

$$\text{Benefit Cost Ratio (BCR)}= (\text{Income}) / (\text{Input Cost}) \quad (3)$$

$$\text{Excessive N (\%)}= [(N (\text{applied})-N (\text{optimum})) / N(\text{applied})] \times 100 \quad (4)$$

Where, Y is the pearl millet grain yield (kg ha<sup>-1</sup>), N is the amount of fertilizer applied (kg N ha<sup>-1</sup>), and a, b, c are estimated parameters. Linear regressions were used to establish relationships among variables.

**RESULTS AND DISCUSSION**

The regression analysis showed significant strong relationship between millet grain yield and N application rate at Faisalabad and Layyah during both years of study (2015-2016). The requirement of N level was observed different for different intra row spacing at both locations. The results enumerated that continuous application of N may not be economical for millet farming community. Optimum N level of 176, 177 kg ha<sup>-1</sup> was calculated for Faisalabad

location in year 2015 and 2016, respectively at 15 cm plant spacing. These optimum levels of N responded maximum yield of 3566 kg ha<sup>-1</sup> and 3695 kg ha<sup>-1</sup> in year 2015 and 2016, respectively. Economics of these optimum N did not allow to apply these high amounts of N and resulted to save 31% and 45% excessive N at 200 kg ha<sup>-1</sup>, 250 kg ha<sup>-1</sup> N rate, respectively during year 2015 and 2016 at Faisalabad location. However, increasing or reducing plant spacing resulted in more N requirement for millet with reducing yield at Faisalabad in year 2015 and 2016. Similarly, in case of Layyah, maximum yield of millet (3674, 3644 kg ha<sup>-1</sup>) were recorded at optimum N levels of 188 kg ha<sup>-1</sup>, 174 kg ha<sup>-1</sup> during year 2015 and 2016, respectively at 15 cm plant spacing. The difference in yields and N rates during both years is non-significant. However, the economically optimum N levels were found 29%, 33% less over N<sub>200</sub> and 43, 47% less over N<sub>250</sub> in year 2015 and 2016, respectively. The amount of excessive N at N<sub>200</sub> and N<sub>250</sub> in district Layyah for both year is non-significant at 10cm and 20cm plant spacing. Saeed et al., 2017 determined N losses for wheat crop and optimize economic level of N.

Table 1: Optimum N rates for maximum millet grain yield, economical millet grain yield, and excessive N of millet at Layyah (arid) and semi-arid (Faisalabad) environments during 2015 and 2016

Plant Spacing	Optimum N (kg ha <sup>-1</sup> )		Maximum Yield (kg ha <sup>-1</sup> )		Economically Optimum N (kg ha <sup>-1</sup> )		Excessive N at N <sub>200</sub> (%)		Excessive N at N <sub>250</sub> (%)	
	2015	2016	2015	2016	2015	2016	2015	2016	2015	2016
<b>(a) Faisalabad</b>										
10 cm	195	194	3034	3153	145	145	27.5	27.5	42	42
15 cm	176	177	3566	3695	138	138	31	31	45	45
20 cm	198	174	3019	2761	157	139	21.5	30.5	37	44
Mean	190	182	3206	3203	147	141	27	30	41	44
<b>(b) Layyah</b>										
10 cm	191	173	3227	3097	142	131	29	34.5	43	48
15 cm	188	174	3674	3644	141	133	29.5	33.5	44	47
20 cm	187	171	3001	2841	142	132	29	34	43	47
Mean	188	172	3300	3194	141	132	29	34	43	47

Assuming Prices: N = 0.79\$ per kg and Millet grain = 0.23\$ per kg

## CONCLUSION

It is concluded that empirical modeling through use of quadratic relationship and economic analysis is a good approach to economically optimize N application. Excessive use of N can be easily managed to a resource efficient use of inputs. So, this study concluded that optimum economic level of N should be sought out according to site specific environment for good production of hybrid pearl millet.

## REFERENCES

- Ullah, A., A. Ahmad, T. Khaliq and J. Akhtar. 2017. Recognizing production options for pearl millet in Pakistan under changing climate scenarios. *Journal of Integrative Agriculture*. 16 (4): 762-773.
- Spitalniak, J., D.L. Wright, I.D. Teare and N.R. Usherwood. 1995. Nutrient uptake (NPK) and growth stage for pearl millet, tropical and temperate com, p. 102-107. In First National Grain Pearl Millet Sym. Proc. Tifton, Georgia.
- Saeed, U., S.A. Aftab, T. Khaliq and Z.A. Zahir. 2017. Optimizing irrigation and nitrogen for wheat through empirical modeling under semi-arid environment. *Environ. Sci. Pollut. Res.* DOI 10.1007/s11356-017-8733-y.
- Maman, N., S.C. Mason, T. Galusha and M.D. Clegg. 1999. Hybrid and nitrogen influence on pearl millet in Nebraska: yield, growth, and nitrogen uptake and nitrogen use efficiency. *Agron. J.* 91:7 37-743.
- Gascho, G.J., R.S.C. Menezes, WW. Hanna, R.K. Hubbard and J.P. Wilson. 1995. Nutrient requirements of pearl millet, p. 92-97. In First National Grain Pearl Millet Symposium Proceedings. Tifton, Georgia.

## EVALUATION OF THE EFFICIENCY OF A NEW ADDITIVE TO UAN 32 ON THE IMPROVEMENT OF THE NITROGEN ASSIMILATION BY WHEAT

MAIGNAN, VM.<sup>1</sup>, GELIOT, PG.<sup>1</sup>

<sup>1</sup> Via Végétale, France

### INTRODUCTION

The use of nitrogen fertilizers generates losses by volatilization and leaching. These losses have important environmental consequences but also economic impacts for the farmer. Currently, solutions such as nitrification inhibitors (DMPP) and urease inhibitors (NBPT) exist (Abalos D. *et al.*, 2014). But there is no innovation on the market which improves the efficiency of nitrogen solution (UAN 32) applied on the soil. However, this is cheapest form of nitrogen, the easiest to use and its spreading quality is better, especially in terms of homogeneity.

The aim of this study was to evaluate the potential for improving the nitrogen assimilation by wheat by adding an additive to UAN 32.

### MATERIAL AND METHODS

#### Hydroponics crop test

Hydroponics crop test was done to evaluate the efficiency of two products used in combination with a nitrogen solution (UAN32) in spring wheat cv. Specifik (*Triticum aestivum L.*). Plants were divided in three batches: (i) control (nitrogen solution UAN 32 + non-limiting mineral supplementation), (ii) VNT1 (nitrogen solution + formula VNT1 + supplementation) and (iii) VNT3 (nitrogen solution + formula VNT3 + supplementation). Five weeks after the onset of hydroponic growth, root dry weight (DW), shoot DW and root to shoot ratio were measured. The concentration of nitrates and total nitrogen amount were also analyzed.

#### Field test in micro-plots

Field test in micro-plots was done to evaluate the efficiency of the best product resulting from hydroponics test in application with the UAN 32 in winter wheat cv. Anvergure. Plants were divided in four batches: (i) Ammonitrate X = 180 U Ha<sup>-1</sup>, (ii) Nitrogen Solution X-40, (iii) Nitrogen Solution X, (IIII)VNT3 (Nitrogen Solution X + Formula VNT3). Yield, protein content and Nitrogen Use Efficiency (NUE = (yield x protein content) / 5.7) were measured.

#### Statistical analysis

All parameters were analyzed by one-way ANOVA for each tissue (roots and shoots) separately. The Student test at  $p < 0.05$  was employed for the estimation of statistically significant changes in response to the different treatments. All statistical analyses were performed by R software.

### RESULTS AND DISCUSSION

#### Effects on biomass in hydroponics

VNT3 supply increased significantly the root dry weight compared to the control (UAN 32). Application of VNT3 led to an increase of the shoot dry weight compared to VNT1 supply. But there is no consistent change compared to the control. The root to shoot ratio showed a tendency to allocate more biomass to the roots when plants received VNT1 or VNT3.

#### Effects on nitrogen in hydroponics

We observed that application of VNT1 or VNT3 reduced significantly the concentration of  $\text{NO}_3^-$  in roots compared to the control. In the same way, VNT3 supply slightly decreased  $\text{NO}_3^-$  concentration in shoots compared to the control and VNT1.

N amounts are very low in roots compared to the shoots. However, we demonstrated that N root amounts are significantly higher when we applied VNT1 or VNT3 compared to the control. In shoots, there was no consistent change. VNT3 application just slightly increased N total amount in shoots.

The results showed that VNT3 formulation increased roots biomass (+15% compared to the control) and N total uptake (+10% compared to the control). However, VNT1 formulation did not have a significant effect compared to the control (Figure 1).

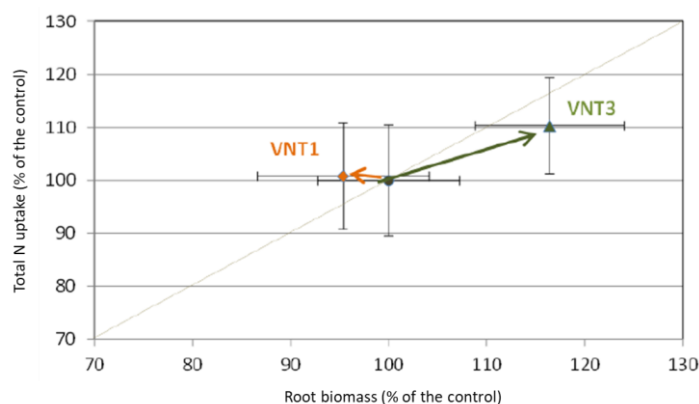

Figure 1: Effect of VNT1 and VNT3 on nitrogen uptake and root development

## CONCLUSION

This study showed a better nitrogen assimilation with VNT3 application in wheat plants in hydroponics conditions. The increase of root biomass and the low nitrate concentration in roots and shoots (suggesting an important activity for nitrate reductase), reveal that this additive stimulates nitrogen metabolism. The micro-plot trial confirms these results even if the pedoclimatic conditions could reduce the efficiency of the product. Others studies including different kinds of soil and measuring specific parameters such as enzymes and genes have to be done for this product to better understand the mechanisms of stimulation and thus optimize the formulation. These studies could also be built from the genes expressions results (N-P-K transporters and abiotic stresses genes) recently obtained on tomatoes.

**Acknowledgements:** We acknowledge Jean-Christophe Avice for correction and kindly improving the English of the manuscript.

## REFERENCES

Abalos D. et al., 2014, Meta-analysis of the effect of urease and nitrification inhibitors on crop productivity and nitrogen use efficiency, *Agriculture, Ecosystems & Environment*, Volume 189, Pages 136-144

## **INFLUENCE OF PEA, LENTIL AND FABA BEAN ON SOIL MICROBIAL ACTIVITIES IMPLICATED IN SULFUR AND NITROGEN MINERALIZATION**

SLEZACK-DESCHAUMES, S.<sup>1</sup>, GENESTIER J.<sup>1</sup>, VOISIN, A.S.<sup>2</sup>, PIUTTI, S.<sup>1</sup>

<sup>1</sup>UMR 1121 Agronomie et Environnement, Université de Lorraine-INRA, TSA 40602, 54518 Vandœuvre cedex, France ; <sup>2</sup>UMR 1347 Agroécologie, Université de Bourgogne-INRA, 17 rue Sully, BP 86510, 21065 Dijon cedex, France

### **INTRODUCTION**

Integration of legumes in the crop rotation provides several benefits. These benefits are assumed to be partly due to an increase in soil nitrogen (N) availability. Legumes could also modulate the soil content in sulfur (S) since this element is essential for symbiotic N fixation. As a consequence, legumes could alter microbial communities involved in N and S mineralization. However, the influence of legumes on soil functioning may differ widely among species. In fact, legumes species can present distinct abilities to fix N and different characteristics in their root system that would influence nutrient acquisition (Wending et al., 2016) and the release of rhizodeposits. The aim of our study was to have a better understanding of the factors by which legume species influence microbial activities involved in N and S mineralization. The objectives were therefore: 1) to characterize the root traits of 3 legumes species *i.e.* pea, lentil and faba bean, 2) to analyze soil variables (microbial biomass C and N, organic extractable C and N) and microbial activities implicated in N (proteases, aminopeptidases) and S (arylsulfatase) mineralization and 3) to discuss the relationships between root traits of legumes and microbial activities. For that purpose, a field experiment was conducted.

### **MATERIAL AND METHODS**

#### **Field experiment**

The field experiment was established at the Epoisses experimental farm (Bretenières, France, 47° 14', 29'' N, 4°06'54'' E). Pea, faba bean and lentil were sown in October, 2015, with 3 repetitions per legume species. No fertilization was done. Soils were sampled under each plant cover using a hand auger (first 15 cm) at the beginning and at the end of vegetative stages and at mid-flowering of crops. The roots were manually separated from the soil using tweezers. The roots were gently cleaned under tap water, and root traits were immediately measured. The soil was stored at 4°C until processing.

#### **Root trait measurements**

Roots were scanned at a resolution of 400 dpi using a flatbed Epson Expression 10000XL scanner. The scanned images were analyzed according to Romillac et al. (2015) in order to determine the total root length, the projected root surface area, the root mean diameter (mm) and the root length distribution per root diameter class. The fine root length percentage was calculated as the percentage of the total root length represented by roots with a diameter < 0.2 mm. The root fresh and dry weights (g) were determined.

#### **Soil C and N contents and soil microbial biomass C and N**

Soil C and N were extracted with hot water and were measured using a TOC-V CSH (Shimadzu). Microbial biomass C and microbial biomass N were estimated using the fumigation extraction method (Vance et al., 1987). Extractable C and N concentrations were determined using a TOC-V CSH (Shimadzu).

#### **Arylsulfatase, aminopeptidase and protease activities**

Potential arylsulfatase activity was determined according to Tabatabai and Bremner (1970). Potential protease activity was determined according to Romillac et al. (2015). Leucine and arginine aminopeptidases were measured according to Sinsabaugh et al. (2008).

## Statistical analyses

Analysis of variance and Principal Component Analysis (PCA) were conducted using R 3.0.0 software.

## RESULTS AND DISCUSSION

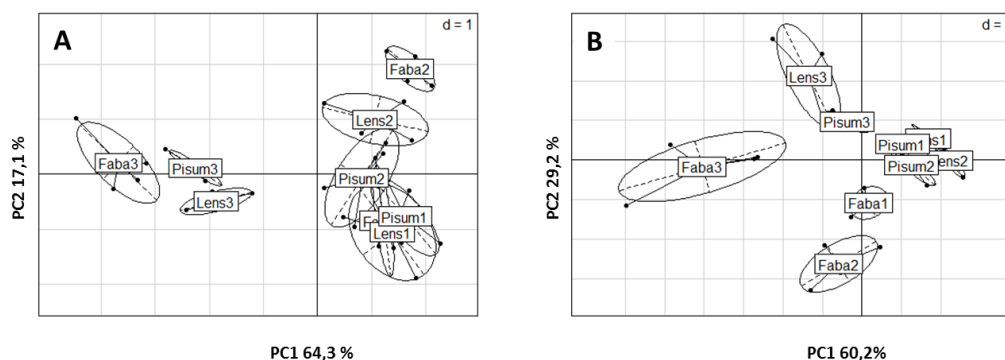

Figure 1. Evolution of soil functioning (A) and root traits (B) at the beginning (1) and the end (2) of vegetative phase and at mid-flowering (3) under pea (*Pisum*), lentil (*Lens*) and Faba bean (*Faba*) covers analyzed by Principal Component Analyses.

### Evolution of soil functioning

PCA showed that soil functioning changed during legume development (Figure 1A). PCA revealed also that legume species differentially influenced soil functioning at the end of the vegetative phase. At this phase, the microbial biomass N was significantly lower under faba bean compared to pea and lentil whereas as the C/N ratio of the soil extractable C and N was higher under faba bean. Soil protease and soil arylsulfatase activities were significantly higher under faba bean at the end of vegetative phase. These findings could suggest that, under faba bean, N and S are more limiting for soil microorganisms. This would favor microbial activities implicated in N and S mineralization.

### Evolution of plant root traits

PCA showed that root traits varied throughout legume development, even if the magnitude of this evolution was less pronounced for pea and lentil than for faba bean (Figure 1B). Whereas pea and lentil root traits seemed to be quite similar, faba bean root traits were distinct from that of the other species, whatever developmental stage considered. Faba bean showed a higher root biomass. This was accompanied by a higher mean root diameter and a lower percentage of fine roots. These root traits would favor resource conservation in faba bean, as previously suggested by Wendling et al. (2016).

## CONCLUSION

This study revealed that faba bean had a differential influence on soil functioning compared to pea and lentil. In particular, faba bean stimulated microbial activities implicated in the mineralization of soil organic N and S at the end of the vegetative phase. This could be related to the contrasting root morphology between faba bean and the two other legume species. Notably, the lower percentage of fine roots, which have shorter longevity than coarse roots, could decrease the release of N and S resources for microorganisms into the soil. This would favor the mining of soil organic N and S by microorganisms in order to alleviate nutrient limitations.

## REFERENCES

- Romillac N., Piutti S., Amiaud B., Slezack-Deschaumes S., 2015. Influence of pea root traits modulating soil bioavailable C and N effects upon ammonification activity. *Soil Biol. Biochem.*, 90, 148-151.
- Sinsabaugh R.L., Lauber C.L., Weintraub M.N., Ahmed B., Allison S.D., Crenshaw C., Contosta A.R., Cusack D., Frey S., Gallo M.E., Gartner T.B., Hobbie S.E., Holland K., Keeler B.L., Powers J.S., Stursova M., Takacs-Vesbach

- C., Waldrop M.P., Wallenstein M.D., Zak D.R., Zeglin L.H., 2008. Stoichiometry of soil enzyme activity at global scale. *Ecology Lett.*, 11, 1252-1264.
- Tabatabai M.A., Bremner J.M., 1970. Arylsulfatase activity of soils. *Soil Sci. Soc. Am. J.*, 34, 225-229.
- Vance E.D., Brookes P.C., Jenkinson D.S., 1987. An extraction method for measuring soil microbial biomass C. *Soil Biol. Biochem.*, 19, 703-707.
- Wending M., Büchi L., Amossé C., Sinaj S., Walter A., Charles R., 2016. Influence of root and leaf traits on the uptake of nutrients in cover crops. *Plant Soil*, 409, 419-434.

## SOIL NITROGEN DYNAMICS IN INTERCROPPED WHEAT (*TRITICUM AESTIVUM*) AND WHITE LUPIN (*LUPINUS ALBUS*)

DE OLIVEIRA, A. B.<sup>1,2,3</sup>; HINSINGER, P.<sup>2</sup>; YVIN, J. -C.<sup>1</sup>; ARKOUN, M.<sup>1</sup>; LE CADRE, E.<sup>3</sup>

<sup>1</sup>Centre Mondial de l'Innovation Roullier - Agro Innovation International Society, France; <sup>2</sup>Joint Unit Research SUPAGRO INRA IRD CIRAD Functional ecology and Biogeochemistry of Soils and Agroecosystems (UMR Eco&Sols), France; <sup>3</sup>Joint Unit Research AGROCAMPUS OUEST INRA Soil, Agro- and Hydro-systems, Spatialization (UMR SAS), France

### INTRODUCTION

Intercropping is a cropping system in which several species are growing in a field during a significant period of their life cycle. This cropping system becomes a promising alternative to intensive agriculture in many countries due to ecological regulations (Brooker et al., 2015). While benefits of mixed cropping in terms of yield gains are listed in a large body of literature, only scarce studies focused on the effects of such systems on soil quality, particularly soil chemical and microbiological properties involved in nitrogen (N) cycle. Plant species are known to shape microbial communities in their rhizosphere, by different amount and composition of root exudates (Song et al., 2007). However, little is known about the common microbial community existing in intercropping systems and the resulting changes in nutrient cycling. Since nitrification, and especially its first step (i.e. ammonia oxidation to nitrite), is essential to N-cycling regulation in agroecosystems, more studies are needed to examine changes of this key process under mixed crops conditions. Soil nitrification has been demonstrated to be positively related to the abundance of the two groups implicated in oxidation of ammonia to nitrite, the ammonia-oxidizing bacteria (AOB) and archaea (AOA) (Zhang et al., 2015). We assumed that intercropping lead to an increase in soil microbial biomass and AOB/AOA abundances due to a higher diversity of rhizodeposits through direct effects or indirect effects by modifying soil chemistry. Hence, the aim of this study was to investigate modifications in soil N dynamics under cereal-legume intercrops, especially in terms of changes in microbial and chemical-related N parameters compared to the respective sole crops.

### MATERIAL AND METHODS

A complete factorial pot experiment was conducted in a greenhouse from September to December 2017 on a calcareous Cambisol with wheat (*Triticum aestivum* var. Lennox) and white lupin (*Lupinus albus* var. Feodora) in both mixing (WL) and respective sole crops (W and L) at 3 soil nitrogen levels (N0 = 61 mg kg<sup>-1</sup> soil; N1 = 92 mg kg<sup>-1</sup> soil; N2 = 124 mg kg<sup>-1</sup> soil) to influence plant interactions, with 7 replicates. Pots were filled with 2 kg of air-dried soil and 200 g of perlite beads (1:1 volume ratio). Plants densities were of 4 in W, 2 in L and 2/1 in WL treatments. Pots were maintained at 70% of the soil field capacity all over the experiment. At flowering, we measured the nitrogen content of plants (root and shoot), and soil chemical (nitrate [NO<sub>3</sub>], ammonium [NH<sub>4</sub><sup>+</sup>] concentrations, and pH) and biological variables (total microbial biomass, abundance of ammonia-oxidizing bacteria [AOB] and archaea [AOA] and microbial carbon and nitrogen contents [MBC, MBN]) in two compartments (rhizosphere and bulk soil). Statistical analysis differences were performed with R software, version 3.3.2, by Tukey's multiple comparison tests at the 0.05 probability level.

### RESULTS AND DISCUSSION

Globally, intercropping (WL) has contrasted effects on microbial biomass relative to sole crops. We measured only a significant difference for MBC, with WL presenting higher values than L, but similar to those in W, at N1 treatment. MBC, MBN and NH<sub>4</sub><sup>+</sup>\_N contents were significantly greater ( $p < 0.001$  for MBC and MBN;  $p < 0.05$  for NH<sub>4</sub><sup>+</sup>\_N) in the rhizosphere relative to the bulk soil. The NO<sub>3</sub><sup>-</sup>\_N concentration was significantly more important in the bulk treatments ( $p < 0.001$ ) compared to other treatments, and for the L treatment whatever the soil compartment (Figure 1). Interestingly, NH<sub>4</sub><sup>+</sup>\_N concentration in the L treatment was similar to intercropped crops in rhizosphere. We hypothesize that nitrification rate can be modified in rhizosphere of L compared to the other



treatments. Plant and molecular biology analyses planned will confirm this interpretation. If confirmed, it will be interesting to investigate if this nitrification potential is maintained after several cycles of mixed cropping.

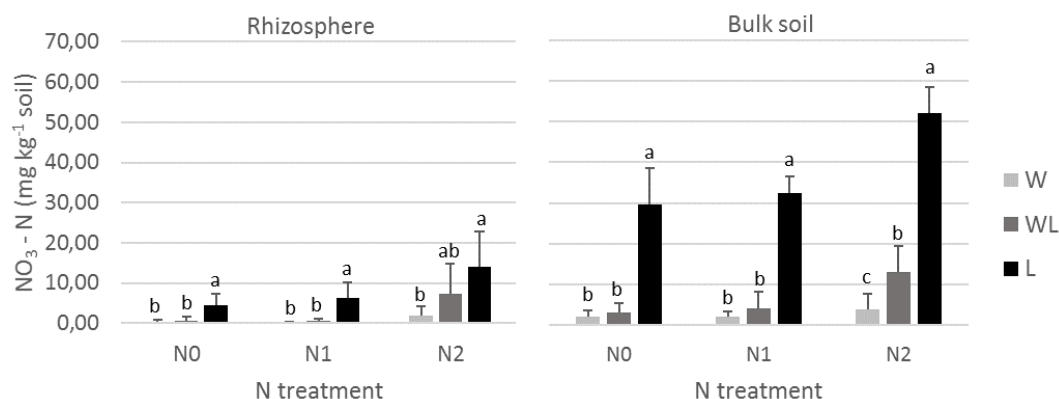

Figure 1. NO<sub>3</sub>-N contents in the rhizosphere and bulk soil of the different crop treatments (W – sole wheat; L – sole lupin; WL – wheat/lupin mixed crop) within each soil nitrogen treatment (N0, N1, N2 = 61, 92 and 124 mg N kg<sup>-1</sup> soil). Bars indicate standard errors. Different letters indicate significant differences at  $p < 0,05$  between crop treatments within each N level.

## CONCLUSION

Preliminary results showed that intercropping did not present a significant effect (i.e. higher values) on microbial biomass as initially assumed. However, interesting results concerning soil NO<sub>3</sub>-N contents were found in particular when lupin is present. Other planned biological analyses (plant; soil AOA/AOB abundances and nitrification potential) will complete the present data for further interpretation of our results in order to confirm or reject our initial hypothesis.

**Acknowledgements:** We thank Agro Innovation International Society for its financial and technical staff support. We also thank INRA and AGROCAMPUS OUEST for its technical staff support at experiment's harvest.

## REFERENCES

- Brooker, R. W., Bennett, A. E., Cong, W.-F., Daniell, T. J., George, T. S., Hallett, P. D., Hawes, C., Iannetta, P. P. M., Jones, H. G., Karley, A. J., Li, L., McKenzie, B. M., Pakeman, R. J., Paterson, E., Schöb, C., Shen, J., Squire, G., Watson, C. A., Zhang, C., Zhang, F., Zhang, J., and White, P. J. (2015). Improving intercropping: a synthesis of research in agronomy, plant physiology and ecology. *New Phytologist* **206**, 107-117.
- Song, Y. N., Zhang, F. S., Marschner, P., Fan, F. L., Gao, H. M., Bao, X. G., Sun, J. H., and Li, L. (2007). Effect of intercropping on crop yield and chemical and microbiological properties in rhizosphere of wheat (*Triticum aestivum* L.), maize (*Zea mays* L.), and faba bean (*Vicia faba* L.). *Biology and Fertility of Soils* **43**, 565-574.
- Zhang, N. N., Sun, Y. M., Wang, E. T., Yang, J. S., Yuan, H. L., and Scow, K. M. (2015). Effects of intercropping and Rhizobial inoculation on the ammonia-oxidizing microorganisms in rhizospheres of maize and faba bean plants. *Applied Soil Ecology* **85**, 76-85.

## QUANTIFICATION OF AMMONIA, NITROUS OXIDE AND METHANE EMISSIONS FOLLOWING BIOGAS DIGESTATE APPLICATION IN AN ORCHARD FIELD IN THE NORTH CHINA PLAIN

DEHARDE, A.<sup>1</sup>, YUAN, Y.<sup>2</sup>, GAO, Z.<sup>2</sup>, MA, W.<sup>2</sup>, ROELCKE, M.<sup>1,3</sup>, NIEDER, R.<sup>1</sup>

<sup>1</sup>Technische Universität Braunschweig Institute of Geoecology Braunschweig | Germany, <sup>2</sup>Hebei Agricultural University College of Resources and Environmental Science Baoding China, <sup>3</sup>German-Chinese Agricultural Center (DCZ) Beijing | China

### INTRODUCTION

In China, excessive application of mineral and organic nitrogen (N) fertilizers such as urea, animal manure and to an increasing extent biogas digestate (BD) causes high N losses to the environment (e.g., Michalczyk et al., 2016). Pathways for N losses from soils include gaseous N emissions via denitrification and ammonia (NH<sub>3</sub>) volatilization (e.g., Eickenscheidt et al., 2014). Emission of NH<sub>3</sub> is one of the most important N loss pathways in the North China Plain (NCP) (Michalczyk et al., 2016). Re-deposited NH<sub>3</sub> contributes to soil acidification and eutrophication. Ammonia also forms secondary particles, which may be transported over greater distances and can cause serious human health problems (Pacholski et al., 2006). Nitrous oxide (N<sub>2</sub>O) and methane (CH<sub>4</sub>) are potent greenhouse gases that contribute to global warming.

Up to now, almost no comparative investigations on the emissions of environmentally and climate-relevant gases following BD application in the NCP are available.

### MATERIAL AND METHODS

Emissions of NH<sub>3</sub>, N<sub>2</sub>O und CH<sub>4</sub> were quantified simultaneously in an apple orchard near Baoding (38°48'N 115°24'E), Hebei province, in the NCP in April 2017. The experimental soil was classified as an Eutric Cambisol. The soil pH (H<sub>2</sub>O) in 0-20 cm was 8.2 and the texture a silty clay loam. The soil organic carbon content (0-20 cm) was less than 1% while the CaCO<sub>3</sub> content was around 4%. The climate of this region is subhumid with hot, humid summers and cold, dry winters. The annual precipitation is 535 mm and the mean annual temperature is 13 °C.

Biogas digestate from a pig farm (corresponding to 150 kg N ha<sup>-1</sup>) was applied onto the soil surface (surface application: SA), into furrows parallel to tree rows and immediately re-covered with soil (furrow application: FA) and on soil surface with immediate uniform incorporation (IA). In addition, a control treatment (CT) without fertilization was designed. For each application method three replicate plots (1 m x 5 m) were established.

To determine the emissions of N<sub>2</sub>O and CH<sub>4</sub>, gas samples were taken from closed chambers (50 cm \* 50 cm) and analyzed via gas chromatography within 24 hours. Sampling was carried out once a day for 12 days (288 hours). Table 1 shows cumulative emissions from only three sampling events (hours 4, 144 and 288) after start of the experiment. For the measurement of NH<sub>3</sub> the calibrated Dräger-Tube Method (DTM) (Pacholski et al., 2006) was used. The period of measurements included 4 days (96 hours), starting directly after fertilizer application, with about 30 measurements per plot. In parallel, the ambient wind speed was measured at two heights.

### RESULTS AND DISCUSSION

The cumulative N<sub>2</sub>O emissions for 12 days after application were highest for FA (121.87 g N ha<sup>-1</sup>, 0.08% of N applied), followed by IA (65.44 g N ha<sup>-1</sup>, 0.044% of N applied) (Table 1). The results for SA were in an equal dimension like those of CT. The processes forming N<sub>2</sub>O (denitrification and nitrification) are influenced by factors such as water, nitrogen and available C contents in soil (Bateman and Baggs, 2005), which varied significantly among the application methods. For FA, the BD and thus also the moisture and nitrogen were concentrated inside the furrows, while it was spread more or less uniformly over the plots for SA and IA. All application methods led to a slight decrease in CH<sub>4</sub> emissions (Table 1) which means that the soil generally acted as a sink for CH<sub>4</sub>. The cumulative CH<sub>4</sub>-C losses for the different application methods ranged from -7.47 g C ha<sup>-1</sup> to -14.32 g C ha<sup>-1</sup>.

Table 2: Cumulative losses of  $N_2O$  [ $g N ha^{-1}$ ] and  $CH_4$  [ $g C ha^{-1}$ ] 4, 144 and 288 hours after surface application (SA), furrow application (FA), uniform incorporation (IA) of biogas digestate and from a control treatment (CT) (mean values,  $n=3$ ).

Time after BD application [h]	$N_2O$ [ $g N ha^{-1}$ ]				$CH_4$ [ $g C ha^{-1}$ ]			
	SA	FA	IA	CT	SA	FA	IA	CT
4	0.17	0.15	0.20	0.16	-0.007	0.01	-0.03	-0.07
144	9.30	54.37	38.26	7.95	-5.28	-4.60	-3.32	-5.80
288	19.11	121.87	65.44	14.46	-14.32	-9.90	-7.47	-10.80

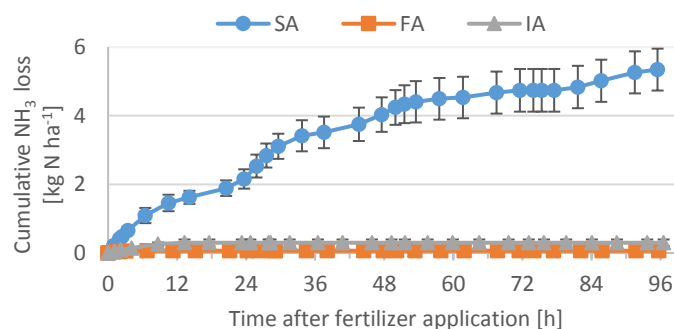

Figure 3: Cumulative  $NH_3$  losses [ $kg N ha^{-1}$ ] after surface application (SA), furrow application (FA) and uniform incorporation (IA) of biogas digestate during 96 hours after start of the experiment (mean values  $\pm$  stand. dev.,  $n=3$ ).

Comparing the application methods, SA led to the highest N losses in form of  $NH_3$  (3.56% of applied N), while the  $NH_3$  losses after IA and FA only accounted for 0.2% and 0.043% of the applied N, respectively (Fig. 1). The efficiency of fertilizer incorporation for reducing  $NH_3$  emissions is widely known (e.g., Pacholski et al., 2006). In the SA treatment the  $NH_3$  volatilization rate was highest with up to  $30.82 mg N m^{-2} h^{-1}$  directly after fertilizer application. However, compared to other investigations with BD, the initial  $NH_3$  fluxes of this study were comparably low. Probably, these low fluxes were a result of the untypically low pH (6.5) of the digestate (Eickenscheidt et al., 2014).

## CONCLUSION

Surface application of biogas digestate in the NCP leads to high N-losses in form of  $NH_3$  while incorporation and furrow application results in higher  $N_2O$  emissions. Due to these antagonistic effects, loss-reducing measures have to be carefully balanced. For methane the detected fluxes were slightly negative, indicating that the soil acted as a sink for  $CH_4$ .

**Acknowledgement:** This study was supported by the DAAD-CSC (PPP project ID 57217922) and the NSFC (No. 41675151).

## REFERENCES

- Bateman E.J., Baggs E.M., 2005. Contributions of nitrification and denitrification to  $N_2O$  emissions from soils at different water-filled pore space. *Biol Fertil Soils* 41, 379–388.
- Eickenscheidt T., Freibauer A., Heinichen J., Augustin J., Drösler M., 2014. Short-term effects of biogas digestate and cattle slurry application on greenhouse gas emissions affected by N availability from grasslands on drained fen peatlands and associated organic soils. *Biogeosciences*, 11, 6187–6207.
- Michalczyk A., Kersebaum K.C., Heimann L., Roelcke M., Sun Q.P., Chen X.P., Zhang F.S., 2016. Simulating in situ ammonia volatilization losses in the North China Plain using a dynamic soil-crop model. *J. Plant Nutr. Soil Sci.*, 179, 270–285.

Pacholski A., Cai G., Nieder R., Richter J., Fan X., Zhu Z., Roelcke M., 2006. Calibration of a simple method for determining ammonia volatilization in the field – comparative measurements in Henan Province, China. *Nutrient Cycling in Agroecosystems* 74, 259–273.

## EFFECTS OF THE NITRIFICATION INHIBITOR DMPSA ON NUTRIENT UPTAKE, NITRATE LEACHING AND CROP GROWTH IN BARLEY AND POTATO IN POT AND FIELD TRIALS

PACHOLSKI, A.<sup>1</sup>, GOEBEL, M.<sup>2</sup>, MEYER, A.<sup>3</sup>, MANNHEIM, T.<sup>1</sup>

<sup>1</sup> Eurochem Agro GmbH, Reichskanzler-Mueller-Str. 23, 68165 Mann, Germany, [Andreas.Pacholski@eurochemgroup.com](mailto:Andreas.Pacholski@eurochemgroup.com), <sup>2</sup> Landesbetrieb Landwirtschaft Hessen, FG 33, Am Versuchsfeld 11-13, 34128 Kassel, Germany, [Maria.Goebel@lh.hessen.de](mailto:Maria.Goebel@lh.hessen.de), <sup>3</sup> Landwirtschaftskammer Niedersachsen, Johannsenstr. 10, 30159 Hannover, Germany, [andreas.meyer@lwk-niedersachsen.de](mailto:andreas.meyer@lwk-niedersachsen.de)

### INTRODUCTION

The application of nitrogen (N) fertilizers can be connected with N losses via nitrate leaching and resulting reduced N efficiency (Velthof et al. 2014). Conversely, low N efficiency due to limitations of N uptake by low availability of other nutrients (e.g. P) can result in nitrate leaching losses. Several measures are proposed to reduce aqueous N losses from managed soils: catch crops, reduced fertilization, buffer strips etc. The use of nitrification inhibitors (NI) as e.g. DCD or DMPP, which prolong the lifetime of the ammonium N form, have been validated in many trials as effective measures to reduce such losses after fertilizer application throughout the vegetation period (e.g. Yu et al. 2007). Fertilizers treated with NI usually have a higher price than untreated, but significant yield increases of about 5 % and 10% nitrogen use efficiency reported across published trials under various agro-ecological conditions (Abalos et al. 2014) pay for the environmental benefit and can provide additional income to the farmer. As one disadvantage in soils with low cation exchange capacity, treatment of urea and surface applied slurry with NI can result in higher ammonia emissions from these sources (Kim et al. 2012). One aspect often not considered in most studies is the positive effect of NI application on P and micronutrient availability to the crop due to sustained ammonium nutrition (Thomson et al. 1993). The NI DMPSA (2-(n-3,4-dimethylpyrazol)succinic acid) was developed to deliver these beneficial effects to N fertilizers to which established NI (DCD, DMPP) cannot be applied with stability, as e.g. calcium ammonium nitrate (CAN) or diammonium phosphate (DAP). DMPSA treated CAN, ASN and DAP were tested in Germany in greenhouse pot trials and in a field trial under simulated leaching water conditions for investigation of their leaching N retardation potential and related yield and nutrient (P, N) uptake effects compared to untreated fertilizers.

### MATERIAL AND METHODS

A pot trial was established in spring 2017 in an aerated greenhouse. Summer barley was seeded in early March in Kick-Brauckmann pots (10 kg of dry sandy loam soil) and supplied with DAP with and without DMPSA at two N levels (0.8 and 1.2 g DAP N/pot) and control without N supply in four replicates. At the beginning of April, four leaching events were initiated on a weekly basis by applying water at a volume corresponding total soil pore space while water was kept on the level of about field capacity in the meantime. After intensive irrigation event, leaching soil water was collected and mineral N concentrations were determined. Aboveground biomass was harvested at EC 40 of barley development and N and P uptake were measured. A second set of the same treatments was established without leaching stress and grown under optimum water supply until full ripeness. In a second trial, potatoes (planted early May) were grown in a field trial on a sandy loam soil in Northern Germany. Fertilizer treatments included CAN, CAN+DMPSA, ammonium sulfate nitrate (ASN)+DMPSA at 200 kg N/ha applied in two splits (4.05. and 15.06.2017) and control without N. The site is equipped with a linear irrigation system providing optimum water supply. At two events excess irrigation was scheduled to simulate high precipitation conditions followed by leaching. The summer was characterized by high rainfall and only one irrigation event was carried out (60 mm on two subsequent days). Leaching water was sampled using passive flux meters (Gee et al. 2009) until end of October 2017. Potato were harvested in September and marketable tuber yield was determined. Yield results were obtained from 4 replicate plots. Two of the 4 plots were each equipped with passive flux meters. Data of both trials were analyzed by ANOVA and Tukey HSD post-hoc test.

### RESULTS AND DISCUSSION

In the pot trial, nitrate leaching was significantly reduced by 90% within a period of 2 month after fertilizer application compared to uninhibited DAP by addition of DMPSA, which roughly corresponds to the inhibited N fraction (100%) (data not shown). Biomass harvested at EC40 was increased by about 20%, while N uptake was 15% higher. In addition to higher N efficiency, P uptake was also strongly increased with addition of DMPSA to DAP by up to 100% (Fig. 1 A). Significantly higher yields and a higher harvest index were observed in the set of treatments without excess irrigation on the lower N level (0.8g N/pot)

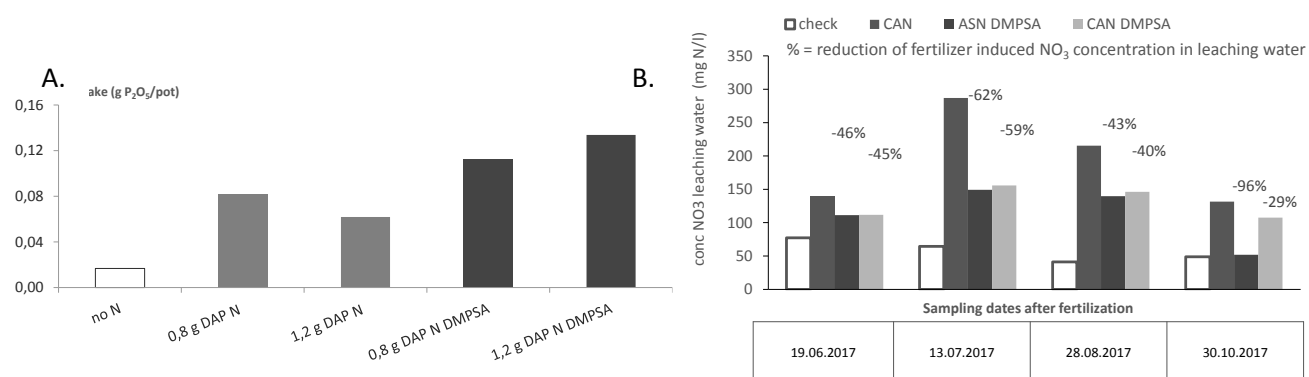

Figure 1 A.) P-uptake by summer barley grown in Kick-Brauckmann pots, DAP applied with and without DMPSA with excess irrigation, no replicates: biomass had be pooled to obtain sufficient plant material; B.) Reduction of nitrate concentration in leaching water compared to untreated CAN by CAN and ASN treated with DMPSA, irrigated potato in Northern Germany.

CAN treated with DMPSA showed an increase of potato marketable and starch yield by 5% and 7% (n.s.), respectively, while DMPSA treated ASN showed no yield effect. Across sampling intervals, nitrate concentrations in leaching water were significantly reduced by on average 50% compared to untreated CAN, with higher reductions in ASN+DMPSA corresponding to the fractions of ammonium N applied by the fertilizers (Fig. 1 B).

## CONCLUSION

Addition of the new inhibitor DMPSA to CAN, DAP and ASN reduced nitrate leaching within the vegetation period (2-6 months) compared to untreated fertilizer by 50 %, up to 90 % in the pot trial. This beneficial effect was accompanied by higher yields as well as higher N und P efficiencies. The use the nitrification inhibitor can be considered as a measure to reduce both, N leaching from excess water and from low N and P uptake efficiency.

## REFERENCES

- Abalos D, Jeffery S, Sanz-Cobena A, Guardia G, Vallejo A., 2014. Meta-analysis of the effect of urease and nitrification inhibitors on crop productivity and nitrogen use efficiency. *Agric. Ecosyst. Environ.* 189, 136–144.
- Gee G.W., Newman B.D., Green S.R., Meissner R., Rupp H., Zhang Z.F., Keller J.M., Waugh W.J., van der Velde M., Salazar J., 2009. Passive wick fluxmeters: Design considerations and field applications. *Water Res. Res.* 45, 1-18.
- Kim D G, Saggar S, Roudier P, 2012. The effect of nitrification inhibitors on soil ammonia emissions in nitrogen managed soils: a meta-analysis. *Nutr. Cycling Agroecosyst.* 93, 51–64.
- Thomson C. J., Marschner H., & Roemheld V., 1993. Effect of nitrogen fertilizer form on pH of the bulk soil and rhizosphere. And on the growth, phosphorus, and micronutrient uptake of bean. *J. Plant Nutrition*, 16 83), 493-506
- Velthof GL, Lesschen J.P., Webb J., Pietrzak S., Miatkowski Z., Pinto M. et al., 2014. The impact of the nitrates directive on nitrogen emissions from agriculture in the EU-27 during 2000–2008. *Sci Total Environ.*, 468, 1225–1233.
- Yu Q., Chen Y., Ye X., Zhang Q., Zhang Z., Tian P., 2007. Evaluation of nitrification inhibitor 3,4-dimethyl pyrazole phosphate on nitrogen leaching in undisturbed soil columns. *Chemosphere*, 67(5):872-8

## **CALIBRATING AIRBORNE MULTISPECTRAL DATA TO AUTUMNAL FRESH MATTER AND N CONTENT OF WINTER OILSEED RAPE**

BUKOWIECKI, J.<sup>1</sup>, PAHLMANN, I.<sup>1</sup>, KAGE, H.<sup>1</sup>

<sup>1</sup> Institute for Crop Science and Plant Breeding, Christian-Albrechts-University, Germany

### **INTRODUCTION**

Winter oilseed rape (WOSR) is one of the major crops in Germany and it is proven to be a high contributor to N surpluses in cropping systems (Henke et al., 2007), hence optimizing its N fertilization is getting into focus. Henke et al. (2009) showed that autumnal canopy N uptake of WOSR is a sensible factor when calculating N fertilization rates in spring. Pahlmann et al. (2017) derived optimal site-specific N application rates from autumnal N uptake, measured by tractor-borne reflection data, and reduced N surpluses significantly.

Recently advancing unmanned aerial vehicle (UAV) technology enables a fast collection of high-resolution spectral data, at considerable low costs. In field trials it was tested if UAV-based multispectral data can be calibrated to fresh matter (FM) and shoot nitrogen of WOSR and whether this calibration is transferrable to predict FM on commercial farms in Northern Germany.

### **MATERIAL AND METHODS**

Data for calibration were collected from September to December 2017 on Hohenschulen Experimental Station of Kiel University. On the test site two different sowing dates and two levels of N fertilization were used to obtain variation in canopy size. At six dates four 1 m<sup>2</sup> areas per block were sampled, FM and N concentration of the plants were determined. Before the sampling an UAV-based camera (Sequoia camera by Parrot™) was utilized to receive multispectral data. The camera collects data in four bands: 530-570 nm (Green), 640-680 nm (Red), 730-740 nm (red edge) and 770-810 nm (near infrared, NIR) with a resolution of 8 \*10<sup>-4</sup> m<sup>2</sup>. The reflectance data was processed in Pix4D Mapper Software (Pix4D SA, Switzerland) and extracted in QGIS v.2.18.6 (QGIS Development Team). The subsequent calculation of vegetation indices (VIs), the fit of linear models between VIs and FM and their evaluation was done with R, Version v.1.0143 (RStudio, 2016).

The same procedure of data sampling and extraction was applied to the validation data measured on six commercial farms (Field (F) 1-6). 10 to 20 sampling spots per field were picked to represent the whole spectrum of present WOSR development.

### **RESULTS AND DISCUSSION**

The simple ratio NIR/Red was the most sensitive VI to FM, providing an efficient way to calibrate the UAV-reflectance data to the collected data on all sites (Table 1). However it was not possible to transfer this calibration to the data from the commercial farms (Figure 1). Particularly in regard to F1 and F6 the relation between VI and FM was different, perhaps due to special radiation conditions during the reflectance data acquisition. Data from F2–5 correspond fairly well with the calibration although high FM values were underestimated. This could be associated by the low maximal FM achieved at the calibration site (Table 1).

Table 1. Number of observations ( $n$ ), maximal and minimal sampled FM ( $FM_{Min}$  and  $FM_{Max}$  in  $kg\ m^{-2}$ ), root mean squared error (RMSE) of the linear model between NIR/Red and the measured FM and their coefficient of determination ( $R^2$ ).

Data origin	n	$FM_{Min}$	$FM_{Max}$	RMSE	$R^2$
Calibration Trial	72	0.01	0.89	0.06	0.94
Commercial farm F1	16	0.32	1.59	0.10	0.92
F2	15	0.32	2.24	0.15	0.94
F3	14	0.41	1.55	0.12	0.96
F4	14	0.14	1.31	0.10	0.92
F5	15	0.15	1.55	0.08	0.96
F6	10	0.12	0.81	0.02	0.99

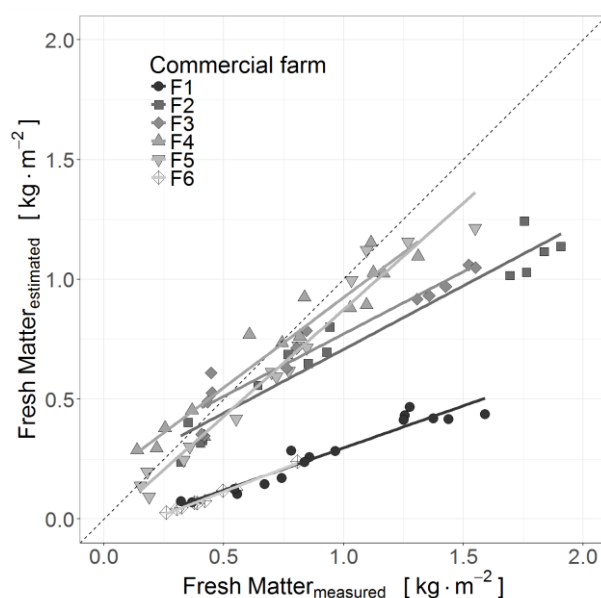

Figure 1. Relationship between the measured FM and the FM estimated by the NIR/Red calibration for the different commercial farms.

## CONCLUSION

First results demonstrate that NIR/Red offers a valuable VI to estimate FM from UAV-based reflectance data. More sampling dates will be included into the calibration and possibly give a hint if it works out for high FM amounts as well. However, ground truth data seem to be necessary to consider for each area separately. Next, the reflection data will be calibrated to N content.

## REFERENCES

- Henke J., Breustedt G., Sieling K., Kage H., 2007. Impact of uncertainty on the optimum nitrogen fertilization rate and agronomic, ecological and economic factors in an oilseed rape based crop rotation. *The Journal of Agricultural Science* 145 (5), 455-468.
- Henke J., Sieling K., Sauermann, W., Kage H., 2009. Analysing soil and canopy factors affecting optimum nitrogen fertilization rates of oilseed rape (*Brassica napus*). *The Journal of Agricultural Science*, 147(1), 1-8.
- Pahlmann I., Böttcher U., Kage H., 2017. Developing and testing an algorithm for site-specific N fertilization of winter oilseed rape. *Computers and Electronics in Agriculture* 136, 228-237.
- R Development Core Team, 2016. R: A Language and Environment for Statistical Computing.



## IMPACT OF BAND APPLICATION AT 2-5 CM OF PELLETTED MEAT BONE MEAL ON WINTER OILSEED RAPE YIELD

ENGSTRÖM, L., DELIN, S.

Swedish University of Agricultural Sciences (SLU), Department of Soil and Environment, Sweden;

### INTRODUCTION

In Sweden pelleted meat bone meal (MBM) is a common fertiliser in organic farming. The way in which organic fertilizers are placed in soil during application can affect the biological turnover of nitrogen (Sørensen & Jensen, 1995; Sørensen & Amato, 2002). Application in bands with a sowing machine achieves a deeper incorporation and also keeps the pellets more concentrated and less mixed with the soil. In this study we wanted to find out if band application of MBM to a certain depth between the rows in spring, compared with broadcasting, would increase yield and N-use efficiency in winter oilseed rape. We also wanted to examine the effect of band application under the row and between rows at sowing compared with broadcasting at sowing.

### MATERIAL AND METHODS

Three experiments were carried out in a hybrid winter oilseed rape (*Brassica napus L.*) seeded at 25 cm row spacing, on two loam soils and one clay soil in Sweden (58°N,13°E) during the growing seasons of 2014/2015 and 2016/2017. Eight treatments were randomised into four blocks and involved band application of 80 kg total-N ha<sup>-1</sup> as MBM (Ekoväx 8-3-5-3) at 2 and 5 cm soil depths between the crop rows in spring and at sowing band application at 5 cm depth between and under the rows (Table 1). The treatments were compared to surface broadcasting in spring and at sowing, mineral N fertiliser (80 kg N ha<sup>-1</sup>) in spring and an unfertilised control. Each plot was 0.7 m<sup>2</sup>, sown and fertilized by hand. The two rows in the middle of the plot (0.25 m<sup>2</sup>) were harvested. The yields in all treatments were compared using General Linear Model one factor analysis in the statistical software Minitab16 (Minitab Inc. 2010).

### RESULTS AND DISCUSSION

On average for three experiments all fertilised treatments except broadcasting in spring gave increased yield compared to unfertilised control. MBM placed in bands at 2 and 5 cm in spring led to 380 kg ha<sup>-1</sup> (n.s) and 770 kg ha<sup>-1</sup> (p= 0.07) higher grain yield respectively compared with broadcasting, whereas band application at sowing between (p= 0.99) or under the rows (p=0.99) did not increase yield compared with broadcasting at sowing (Figure 1). Compared with the yield effect of mineral N fertilisation in spring, band application at 5 cm at sowing and in spring was 82 and 88 % respectively, band application at 2 cm in spring was 76 %, broadcasting at sowing was 77 % and in spring 67 %. Although mineral N fertiliser in spring had the highest yield, it was not significantly higher than band application at 5 cm (between rows) in spring or at sowing. There were no differences in yield for fertilisation of MBM at sowing compared with fertilisation in spring. The treatments had no impact on plants per m<sup>2</sup> or weed biomass. In a similar study also performed in small plots (0.7 m<sup>2</sup>), band application of pelleted MBM at 4-6 cm soil depth and 4 cm from crop row in spring oats, seeded at 25 cm row spacing, more than doubled the fertilisation effect on nitrogen uptake and grain yield compared with broadcasting (Delin & Engström, unpublished).

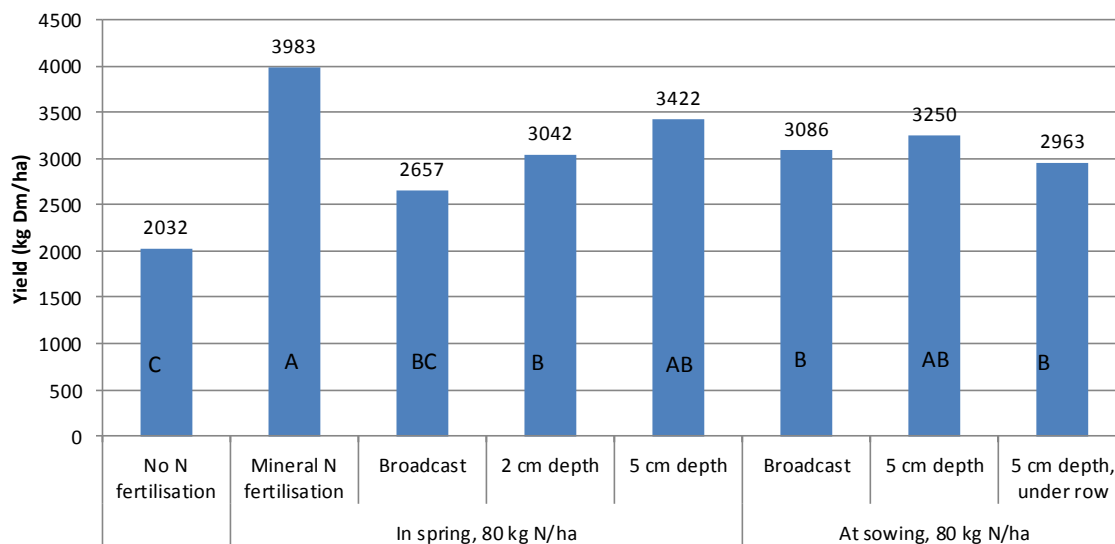

Figure 1. Yield effect in winter oilseed rape of pelleted meat bone meal applied in bands in spring (at 2 and 5 cm depth) and at sowing (at 5 cm depth) compared with broadcasting, no fertilisation and mineral N fertilisation, three experiments 2014/2015 and 2016/2017.

Table 1. Eight treatments of mineral N fertiliser and pelleted meat bone meal (MBM) in winter oilseed rape with a row distance of 25 cm.

Treatment	Application-time	Fertiliser	Method of application	N-rate kg total-N/ha
1		No N fertilisation	-	0
2	In spring	Mineral N fertilisation	Broadcast	80
3	In spring	MBM	Broadcast	80
4	In spring	MBM	2 cm soil depth between rows	80
5	In spring	MBM	5 cm soil depth between rows	80
6	At sowing	MBM	Broadcast	80
7	At sowing	MBM	5 cm soil depth between rows	80
8	At sowing	MBM	5 cm soil depth, under row	80

## CONCLUSION

In spring, incorporation of 80 kg total-N ha<sup>-1</sup> as pelleted MBM to 5 cm soil depth can have a significant yield effect of +29 % DM yield compared to broadcasting. At sowing, incorporation to 5 cm depth between or under rows had a similar effect on yield as broadcasting. Broadcasting at sowing tended to give a higher yield than broadcasting in spring in these three experiments and two years.

**Acknowledgements:** This study was financed by SLU Ekoforsk.

## REFERENCES

- Sørensen P., Amat M. 2002. Remineralization and residual effects of N after application of pig slurry to soil. *European Journal of Agronomy*, 16, 81-95.
- Sørensen P., Jensen E. S. 1995. Mineralization-immobilization and plant uptake of nitrogen as influenced by the spatial distribution of cattle slurry in soils of different texture. *Plant & Soil*, 173, 283-291.

## FIRST ANALYSIS OF THE NITRATE LEACHING RISK FOR DIFFERENT FERTILISERS IN THE PERSEPHONE PROJECT

DAIGNEUX, B.<sup>1</sup>, MOLITOR, N.<sup>2</sup>, GENNEN, J.<sup>1</sup>, DEBBAUT, V.<sup>2</sup>, TSACHIDOU, B.<sup>3</sup>

<sup>1</sup>Agra-Ost, Belgium; <sup>2</sup>ULiège – Sensing of Atmosphere and Monitoring, Belgium; <sup>3</sup>Luxembourg Institute of Science and Technology, Luxembourg

### INTRODUCTION

In the context of the Project «Perséphone: Intégration de la filière biogaz dans la nouvelle Bio-économie», financed by the European Regional Development Fund 2014-2020 INTERREG VA «Greater Region», our non-profit association is in charge of five organic and chemical fertilization field trials (2017-2019). This paper is based on the first data collected through 2017 and will present the analysis of the nitrate leaching risk for that year under permanent cut grassland. Koszela et al. (2015) demonstrated the fertilisation capacity of biogas residues, while Odlare et al. (2007) observed that biogas residues enhanced the proportion of metabolically active microorganisms, nitrogen mineralization capacity and had no negative effects on either chemical or microbiological properties of the soil. On the other hand, in a study performed by Wang et al. (2016), the application of biogas residues resulted into increased nitrogen volatilization. Therefore, to study the environmental impact, it is important to estimate soil nitrate leaching risk, especially during autumn, the focus point of this presentation. This study will also help to assess the value of biogas residues as an organic fertilizer and to evaluate its environmental benefits, to compare the impact of each tested fertilizer on the yield, microbial activity and evolution of soil physicochemical properties, and to assess the environmental risk induced by an organic based fertilisation scheme on a permanent mown meadow.

### MATERIALS AND METHODS

In this ongoing field trial, four different fertilisers are tested in three areas (Emmels (Be), Grendel (Be) and Laneuvelotte (Fr)). The fertilizers applied are i) local biogas residues at 350 units of total N/ha, ii) biogas residues of Faascht farm (Grendel, Be) at 230 U of N/ha, iii) local manure at 230 U of N/ha and iv) ammonium nitrate at 230 U of N/ha, which are compared to the unfertilized control (Te) and among each other. Nitrate leaching risk is indicated by mineral N measurement in soils which takes place in February, before fertilizer application, and in October, after the last forage harvest. This is the recommended strategy in Belgium. A high nitrate content in soil will increase the potential nitrate leaching risk. As Vandenberghe cited (2013), during the year, nitrogen measurements are taking place by GxABT of Uliège and UCL to provide reference for the farmers. Soil cores of 90 cm are collected and divided in layers of 0-30, 30-60 and 60-90 cm which subsequently are analysed for nitrate content. For our statistical analysis we used R studio software (R version 3.4.3 (2017-11-30)).

### RESULTS AND DISCUSSION

An ANOVA test performed shows that the risk for nitrate leaching differs in regard of the treatments ( $p < 0.001$ ). The post-hoc Tukey's analysis demonstrates significant differences between variants. This first assessment of nitrogen leaching risk reveals no significant differences between the 2 biogas residues treatments and the control ( $p < 0.05$ ). A similar conclusion has been drawn for the manure variant ( $p < 0.05$ ) though values are slightly higher. On the contrary, the ammonium nitrate variant (230 U of N/ha) shows a significant difference compared to the control ( $p < 0.001$ ). In addition, the average value of the soil nitrate concentration under the application of ammonium nitrate is considerably higher compared to the rest of the variants, as demonstrated in the figure 1.

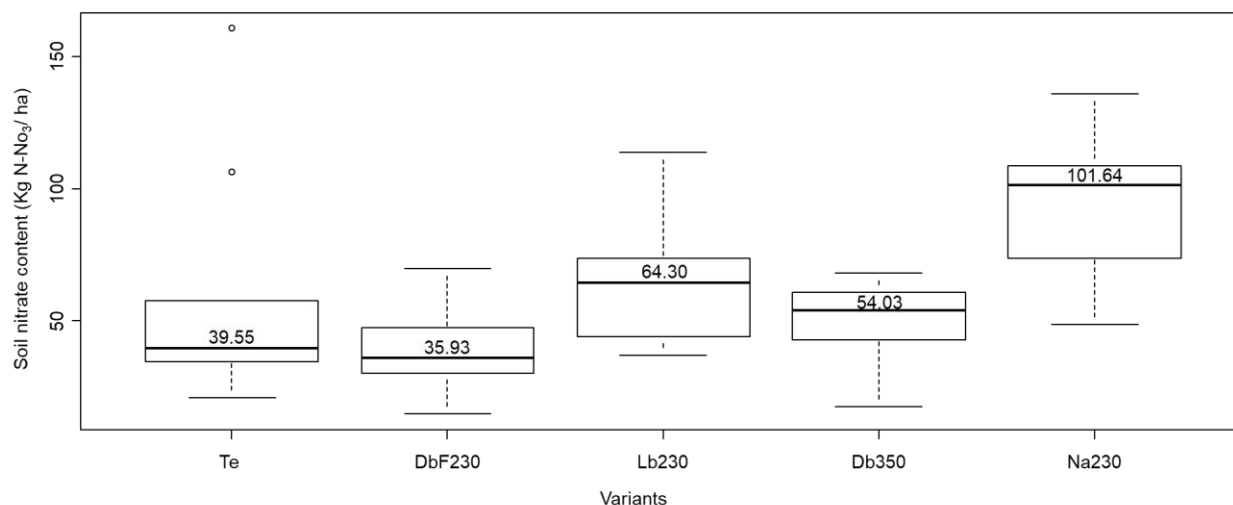

Figure 4: Box plot of soil nitrate content (kg N-NO<sub>3</sub>/ha) after the application of four different fertilizers. Caption: Te = Control, DbF230 = Biogas residues of Fascht farm at 230 U of N/ha, Lb230 = local manure at 230 U of N/ha, Db350= local biogas residues at 350 U of N/ha, Na230 = ammonium nitrate at 230 U of N/ha

## CONCLUSION

Our data show that the use of biogas residues and manure do not increase the values of nitrate leaching even at the maximum dose of 350 U of N/ha. In addition, it is important to note that part of the nitrogen present in biogas residues and manure is found in the organic matter. The release of this organic nitrogen depends on ammonification and nitrification. These processes are retroactive in regard of the fertilisation and highly depend on the weather conditions. Organic and mineral fertilisation will continue throughout the following years and the measurements obtained will indicate if the organic matter, present in biogas residues and manure, has the potential to increase or mitigate nitrate leaching risk.

**Acknowledgements:** The presented research was carried out as a part of the research project Interreg VA Grandrégion « Perséphone: Intégration de la filière biogaz dans la nouvelle Bio-économie ». This project is funded with the help of FEDER, German-speaking community of Belgium and Wallonia. Authors also thank all the partners of the project, especially Philippe Delfosse and Bella Tsachidou for their suggestions on the sampling scheme and the constructive discussions.

## REFERENCES

- Koszel, M., & Lorencowicz, E. (2015). Agricultural Use of Biogas Digestate as a Replacement Fertilizers. *Agriculture and Agricultural Science Procedia*, 7, 119–124.
- Odlare, M., Pell, M., Svensson, K. (2008). Changes in soil chemical and microbiological properties during 4 years of application of various organic residues. *Waste Management*, 28(7), 1246-1253.
- Wang, L. L., Li, W. Z., Wang, Z. J., Wang, Z. W., Sui, C., & Li, Y. (2016). Effects of digestate application depth on soil nitrogen volatilization and vertical distribution. *International Journal of Agricultural and Biological Engineering*, 9(5), 101–107.
- Vandenbergh, Christophe; De Toffoli, Marc; Bachelart, Florent; Imbrecht, Olivier; Lambert, Richard, Marcoen Jean Marie;(2013). *Biotechnologie, Agronomie, Société et Environnement; Gembloux, Vol. 17, N° suppl 1, 231-236.*

## BIODIVERSITY OF INDIGENOUS RHIZOBIA NODULATING *PHASEOLUS VULGARIS* IN CROATIA

RAJNOVIC, I.<sup>1</sup>, RAMÍREZ-BAHENA, M.H.<sup>2,3</sup>, SÁNCHEZ JUANES, F.<sup>4,5</sup>, GONZÁLEZ BUITRAGO, J.M.<sup>4,5</sup>, KAJIC, S.<sup>1</sup>, PEIX, A.<sup>3,6</sup>, VELÁZQUEZ, E.<sup>2,3</sup>, SIKORA, S.<sup>1</sup>

<sup>1</sup> University of Zagreb Faculty of Agriculture, Department of Microbiology, Croatia; <sup>2</sup> Departamento de Microbiología y Genética and CIALE, Universidad de Salamanca, Spain; <sup>3</sup> Unidad Asociada Grupo de Interacción planta-microorganismo (Universidad de Salamanca-IRNASA-CSIC), Spain; <sup>4</sup> Instituto de Investigación Biomédica de Salamanca (IBSAL), Spain; <sup>5</sup> Departamento de Bioquímica y Biología Molecular, Universidad de Salamanca, Spain; <sup>6</sup> Instituto de Recursos Naturales y Agrobiología, IRNASA-CSIC, Salamanca, Spain

### INTRODUCTION

Common bean (*Phaseolus vulgaris* L.) is very valuable and economically important grain legume. It is rich in proteins, fiber and B vitamin and recently, it has been discovered that common bean consumption can contribute to health improvement. However, common bean production in Croatia is limited to small-scale farmers and generally neglected despite favourable environmental conditions. Since it has been recognized that numerous rhizobial species can nodulate common bean, the main aim of this study was to assess genotypic diversity of indigenous rhizobia isolated from soils of Northwestern Croatia.

### MATERIAL AND METHODS

Soil samples were collected from 27 different locations in Northwestern region of Croatia. Trapping host method was performed to obtain 45 isolates of indigenous common bean symbionts. The identification of isolates was first performed by Matrix-assisted Laser Desorption/Ionization Time-of-Flight Mass Spectrometry (MALDI-TOF MS) which is based on the characteristic protein profiles for each microorganism. Protein profiles obtained from isolates were compared to those contained in database created in Salamanca University, containing the type strains of all currently described species from the Family *Rhizobiaceae* (Ferreira et al., 2011). The results of identification by MALDI-TOF MS were further compared to those based on gene analysis. RAPD method was employed to assess rhizobial genetic diversity and to choose representative strains for further analyses of gene sequences. The sequence analysis of 16S rRNA (*rrs*) and two housekeeping genes, *recA* and *atpD*, was performed to classify isolates obtained from common bean nodules. Since *NodC* gene is the commonly used phylogenetic marker to define symbiovars within species of genus *Rhizobium*, its sequences were analysed to study symbiovars within species of indigenous rhizobia isolated from Croatian soils.

### RESULTS AND DISCUSSION

Indigenous rhizobial strains nodulating common bean have been found in the soils of Northwestern Croatia. The results obtained with MALDI-TOF MS methodology showed that the strains from this study matched different species from the *Rhizobium leguminosarum* phylogenetic group with score values higher than 2.0. The results of the RAPD analysis revealed high diversity among indigenous rhizobial strains and the existence of 15 groups with similarity lower than 70 % from which representative strains were selected for core and symbiotic gene analyses. The *rrs* gene sequences analysis showed that all strains from this study belong to genus *Rhizobium* being their closest related species those of the phylogenetic group of *R. leguminosarum*. Similarity values of 100 % were found between 11 strains and *R. leguminosarum* and *R. hidalgonense* and between 1 strain and *R. pisi*. Three other strains, presented similarity values higher than 99 %, but lower than 100 % with *R. leguminosarum*, *R. pisi* and *R. etli*. Nine out of 11 strains that were closely related to the *R. leguminosarum* phylogenetic group were identified as this species after the analysis of the *atpD* and *recA* housekeeping genes. Other two strains were identified as *R. hidalgonense*, a species recently isolated in America from *P. vulgaris* nodules (Yan et al., 2017). One strain belongs to the species *R. pisi*. Two strains formed an independent branch, most closely related to *R. sophoriradicis*, but with similarity values lower than 98 %. One strain formed an independent lineage more closely related to the species *R. ecuadorensis*, but the similarity values were lower than 97% indicating that it belongs to a new species. Further research is needed to determine taxonomic affiliation of this strain. The results of the *nodC* gene analysis

showed that all indigenous common bean rhizobia from Croatian soils belong to symbiovar phaseoli. This is the first report about the existence of this symbiovar within the species *R. pisi*, which already contains strains from symbiovars viciae and trifolii (Marek-Kozaczuk et al., 2013).

## CONCLUSION

Given that the knowledge about the indigenous population of rhizobia that nodulate common bean in Croatia is very limited, the present study provided an insight into the composition of this group of microorganisms in different soil types of Northwestern Croatia. Further characterization of isolates is needed in order to select the most promising strains for common bean inoculation.

## REFERENCES

- Ferreira L., Sanchez-Juanes F., Garcia-Fraile P., Rivas R., Mateos P.F., Martinez-Molina E., 2011. MALDI-TOF mass spectrometry is a fast and reliable platform for identification and ecological studies of species from family Rhizobiaceae. PLoS ONE 6: e20223.
- Yan J., Yan H., Liu L.X., Chen W.F., Zhang X.X., Verastegui-Valdes M.M., Wang E.T., Han X.Z., 2017. *Rhizobium hidalgonense* sp. nov., a nodule endophytic bacterium of *Phaseolus vulgaris* in acid soil. Archives of Microbiology 199: 97-104.
- Marek-Kozaczuk M., Leszcz A., Wielbo J., Wdowiak-Wrobel S., Skorupska A., 2013. *Rhizobium pisi* sv. trifolii K3.22 harboring nod genes of the *Rhizobium leguminosarum* sv. trifolii cluster. Systematic and Applied Microbiology 36: 252-258.

## **SIMULATED NITROGEN DEPOSITION IN TWO ITALIAN BEECH FORESTS EXPOSED TO DIFFERENT CLIMATE CONDITIONS: EFFECT ON SOIL NITROGEN CYCLING**

MARCOLINI, G.<sup>1</sup>, GIOACCHINI, P.<sup>1</sup>, MAZZENGA, F.<sup>2</sup>, D'ANDREA, E.<sup>2</sup>, RAVAIOLI, D.<sup>1</sup>, MUZZI, E.<sup>1</sup>, MEZZINI, E.<sup>1</sup>, MATTEUCCI, G.<sup>3</sup>, MAGNANI, F.<sup>1</sup>.

<sup>1</sup> Department of Agricultural and Food Sciences (DISTAL), University of Bologna, Italy; <sup>2</sup> National Research Council, Institute of Agro-Environmental and Forest Biology (CNR-IBAF), Italy; <sup>3</sup> National Research Council, Institute for Agricultural and Forestry Systems in the Mediterranean (CNR-ISAFOM), Italy

### **INTRODUCTION**

Atmospheric deposition of reactive nitrogen can affect many forest ecosystem processes including nitrogen cycling, stand growth, nutrient cycling. The effects of N deposition on Northern and Central European forests have been the focus of a number of studies, both observational and manipulative, but only few data are available for southern areas. We established a manipulative N addition experiment in two Italian beech forests characterised by different levels of background N deposition and climate, with the aim to understand the effects of atmospheric N deposition on forest growth and health and on soil N cycling. Here we report the first results of the ongoing experiment on net N mineralization and net nitrification rates, as measured *in situ* by the resin core incubation technique.

### **MATERIAL AND METHODS**

The study sites are located (i) in the Cansiglio Forest, in the Veneto pre-alpine region, and (ii) at Collelongo in the Central Appenines, near two intensive monitoring plots of the Italian national long-term forest monitoring program CONECOFOR (Forest Ecosystem Monitoring; part of the Level II ICP Forest network). At both sites, three treatments are compared: (i) a control treatment (CK) without N addition; soil applications of (ii) 30 kg N ha<sup>-1</sup> yr<sup>-1</sup> (N30) and (iii) 60 kg N ha<sup>-1</sup> yr<sup>-1</sup> (N60); at the Cansiglio site a fourth treatment is included, consisting of 30 kg N ha<sup>-1</sup> yr<sup>-1</sup> sprayed above the canopy so as to better simulate atmospheric N deposition and account for canopy interception and uptake (N30canopy). At both sites, each treatment is replicated (N=3) in a complete randomized design. The N treatments started in 2015 and consist on three equal yearly applications of NH<sub>4</sub>NO<sub>3</sub> solution during the growing season (July, August and September). Annual net N mineralization and net nitrification rates in the upper 20 cm forest soil and potential N leaching were determined *in situ* by the resin core incubation technique (DiStefano and Gholz, 1986; Vestgarden et al., 2003). Briefly, in each plot six undisturbed soil cores were incubated in open PVC-tubes with an ion exchange resin bag at the bottom so as to capture any ions leaching from the soil. Simultaneously six resin bags were placed on the soil surface, next to the cores, in order to estimate the amount of mineral N entering the tubes, either from fertilization or from atmospheric N deposition. Net N mineralization was calculated as the total mineral N present at the end of the incubation period (soil + bottom resin bag) corrected for N inputs (surface resin bag), minus the mineral N present at the beginning of the incubation. Stand growth was measured by stem circumference bands permanently installed on trees in the central area of plots. Treatment effects were statistically analyzed by analysis of variance (ANOVA). In particular, data from soil N treatments were analysed as in a completely randomized factorial experiment design with two factors: site (two levels: Cansiglio and Collelongo) and N applications (3 levels: 0, 30 and 60) with three replicates. All statistical analyses were performed with RStudio (RStudio Team 2014) using packages “easyanova” and “agricolae”.

### **RESULTS AND DISCUSSION**

At both sites, no significant differences between treatments were observed for annual rates of net N mineralization, which resulted of about 95 and 120 kg N ha<sup>-1</sup> yr<sup>-1</sup> at Cansiglio and Collelongo, respectively. Also annual net nitrification rates did not differ among treatments, nor between sites. They reflected net N mineralization rates, indicating that all the N mineralized was nitrified. The amount of nitrogen collected in the

bottom resin trap, which can be viewed as a potential N leaching as it was measured in the absence of plant uptake, increased from approximately 75 to 130 kg N ha<sup>-1</sup> yr<sup>-1</sup> in response to N addition. At both sites, amounts of N collected in the surface resin traps reflected the N additions and were significantly higher in the N60 treatment compared to the others that, at Cansiglio, did not result significantly different as a result of the large spatial variability. Moreover, at Cansiglio, the amount of mineral N collected in the surface resin traps of the N30 canopy treatment represented 54 % of the amount collected in the N30 treatment, suggesting that about half of N aeri ally applied was intercepted by the canopy. After two years of N addition, no significant differences in stand growth were found among treatments.

## CONCLUSION

These first results seem to indicate that both beech forests, despite the different levels of background N deposition, are not N limited, but rather close to N saturation, a result consistent with the negligible effect of N addition on stand growth. It will be important to continue the experiment, so as to explore the long-term effects on tree growth and N uptake, and assess the real N status of the two beech forests.

**Acknowledgements:** We thank the ‘Reparto Biodiversità’ of Vittorio Veneto and the ‘Nucleo Carabinieri Tutela Biodiversità Pian Cansiglio’ for their support in the field work. This work was supported by the MIUR-PRIN Grant ‘Global change effects on the productivity and radiative forcing of Italian forests: a novel retrospective, experimental and prognostic analysis’.

## REFERENCES

- DiStefano J.F., Gholz H.L., 1986. A proposed use of ion exchange resins to measure nitrogen mineralization and nitrification in intact soil cores. *Commun. in Soil Sci. Plant Anal.* 17(9): 989-998.
- Vestgarden L.S., Selle L.T., Stuanes A.O., 2003. *In situ* soil nitrogen mineralisation in a Scots pine (*Pinus sylvestris* L.) stand: effects of increased nitrogen input. *Forest Ecology and Management* 176: 205-216.
- R Core Team (2014). R: A language and environment for statistical computing. R Foundation for Statistical Computing, Vienna, Austria. URL <http://www.R-project.org/>.



## EFFECTS OF N FERTILIZER FORMS AND SOIL PH ON N<sub>2</sub>O EMISSIONS DURING NITRIFICATION

TIERLING, J.<sup>1</sup>, LEBENDER, U.<sup>1</sup>, BRUECK, H.<sup>1</sup>

<sup>1</sup> Research Centre Hanninghof, Yara GmbH & Co. KG, Germany

### INTRODUCTION

Microbial transformations of (mineral) fertilizers on intensively managed agricultural soils are a major source of the greenhouse gas nitrous oxide (N<sub>2</sub>O). Besides denitrification of nitrate, nitrifying processes can significantly contribute to N<sub>2</sub>O emissions. Lebender et al. (2014) reported differences between urea and ammonium salts, although both N fertilizer forms are subject to nitrification after application. Here we present two incubation experiments comparing effects of different N fertilizer forms under well-aerated, nitrifying soil conditions on N<sub>2</sub>O emission rates and nitrogen transformations in the soil.

### MATERIAL AND METHODS

Columns of sandy loam soil (pH = 5.3) were adjusted to a water content of 40% WHC and subsequently fertilized with 82 kg N ha<sup>-1</sup> in the form of potassium nitrate (KN), ammonium sulphate (AS), or urea. Columns were incubated in a greenhouse at 20 °C for 21 days. N<sub>2</sub>O emissions were measured daily with the closed chamber method. Four gas concentration measurements (gas chromatography (GC)) were taken at 0, 15, 30, 45 min closure time, and gas emission rates were estimated using linear regression analysis. Destructive soil samples were taken 0, 4, 7, 11, 14, and 21 days after fertilization. Soil samples were homogenized and analysed for ammonium and nitrate content with continuous-flow analysis. Nitrite content was determined spectrometrically at 543 nm after the addition of Griess reagent. Soil pH was determined in 0.01 M CaCl<sub>2</sub>.

In a second experiment, sandy loam soil was sampled from two treatments of a long-term liming experiment in northern Germany, where pH values differed (5.3 and 6.3). Soil columns fertilized with AS or urea and incubated in a flow-through incubation system, where soil containers are closed during the experiment and continuously flushed with a N<sub>2</sub>O-free gas mixture (21% O<sub>2</sub> in He). The gas stream from each container was directed to a GC. The N<sub>2</sub>O emission rate was then estimated by multiplying the N<sub>2</sub>O gas concentration with the gas mixture flow rate. Additional soil columns were incubated under similar conditions for destructive samplings and soil analysis as described above.

### RESULTS AND DISCUSSION

Both control and KN treatment emitted almost no N<sub>2</sub>O, while AS and urea caused N<sub>2</sub>O emissions over 21 days (Fig. 1, top). Total N<sub>2</sub>O emissions from the urea treatment were almost 4-fold those of the AS treatment (20.8 and 5.4 mg N m<sup>-2</sup>, respectively). While no nitrite was detected in the control and KN treatment and only very little in the AS treatment, nitrite was found in the urea treatment during the whole incubation period (Fig. 1, bottom). The addition of NaNO<sub>2</sub> solution to the soil induced N<sub>2</sub>O emissions as well (data not shown), implying that the higher nitrite concentrations during nitrification of urea caused the higher N<sub>2</sub>O emissions compared to AS (Venterea, 2015).

In the second incubation results for the soil with pH 5.3 were similar to those of the first experiment. Urea fertilization caused 3-fold N<sub>2</sub>O emissions compared to AS. However, when the soil pH was raised to 6.3, N<sub>2</sub>O emissions from AS and urea were comparable. Soil analysis showed that nitrite accumulated during nitrification of AS at pH 6.3, but not at pH 5.3 as it was also shown in the first experiment. This is in line with findings that nitrite accumulation tends to be promoted by higher soil pH values (Van Cleemput and Samater, 1996).

**Table Erreur ! Il n'y a pas de texte répondant à ce style dans ce document.3:** Effect of soil bulk pH and N fertilizer form on N<sub>2</sub>O emissions and the emission factor (EF) from a loamy sand. The incubation period was 52 days under aerobic conditions. Values are means  $\pm$  sd ( $n=3$ ).

Soil pH	N form	N <sub>2</sub> O	EF
		mg N m <sup>-2</sup>	%
5.3	None	0.9	---
	AS	16.9 <sup>a</sup>	0.22
	Urea	46.1 <sup>b</sup>	0.62
6.3	None	0	---
	AS	42.9 <sup>b</sup>	0.59
	Urea	45.6 <sup>b</sup>	0.63

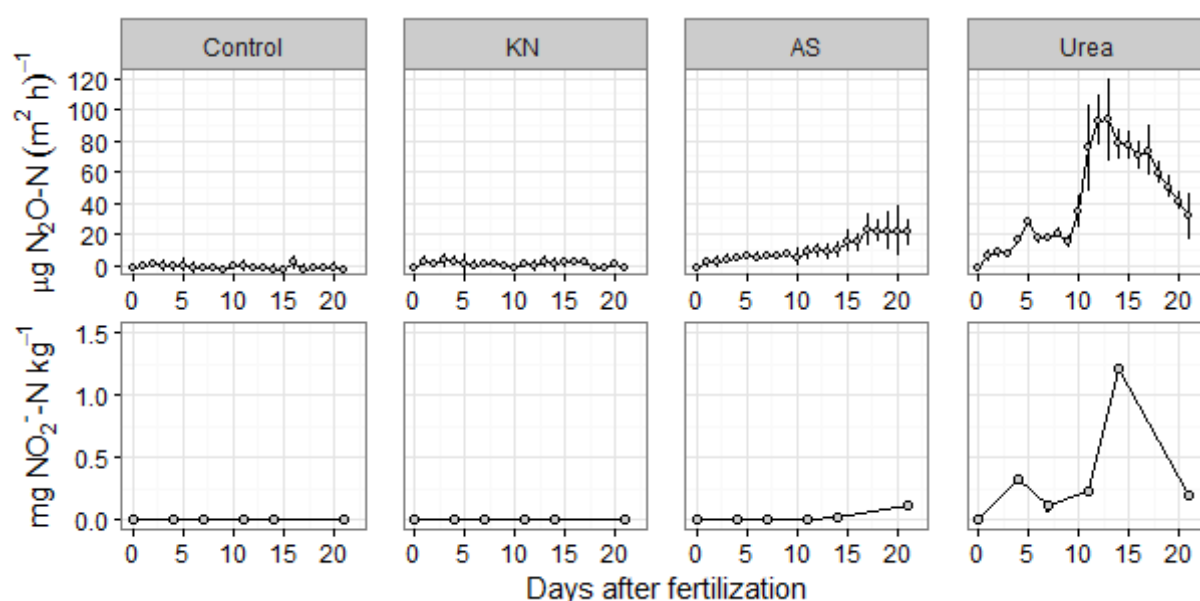

**Figure 1:** Nitrous oxide emission rates and soil nitrite concentrations of a loamy sand soil incubated under aerobic conditions after the application of 8.2 mg N m<sup>-2</sup> either as potassium nitrate (KN), ammonium sulphate (AS), or urea. Plots show mean values  $\pm$  sd ( $n=6$ ).

## CONCLUSION

We conclude that under non-denitrifying conditions the nitrification of fertilizers can lead to nitrite accumulation, which subsequently significantly increased N<sub>2</sub>O emissions, especially at higher soil pH. Compared to AS, urea was even more prone to nitrite accumulation, also at lower pH values, which can be attributed to the alkalinising hydrolysis of urea taking place after fertilizer application.

## REFERENCES

- Lebender, U., Senbayram, M., Lammel, J., Kuhlmann, H., 2014. Effect of mineral nitrogen fertilizer forms on N<sub>2</sub>O emissions from arable soils in winter wheat production. *J. Plant Nutr. Soil Sci.* 177, 722–732.
- Van Cleemput, O., Samater, A. H., 1996. Nitrite in soils: accumulation and role in the formation of gaseous N compounds. *Fert. Res.* 45, 81–89.
- Venterea, R. T., Clough, T. J., Coulter, J. A., Breuillin-Sessoms, F., 2015. Ammonium sorption and ammonia inhibition of nitrite-oxidizing bacteria explain contrasting soil N<sub>2</sub>O production. *Sci. Rep.* 5, 12153.

## ESTIMATING WHEAT GRAIN YIELD AND N UPTAKE BY MULTISPECTRAL IMAGING

CORTI, M.<sup>1</sup>, CABASSI, G.<sup>2</sup>, CAVALLI, D.<sup>1</sup>, VIGONI, A.<sup>3</sup>, ORTUANI, B.<sup>1</sup>, DEGANO, L.<sup>2</sup>, PRICCA, N.<sup>2</sup>, MARINO GALLINA, P.<sup>1</sup>

<sup>1</sup> Department of agricultural and environmental sciences – Università degli studi di Milano, Italy; <sup>2</sup> Consiglio per la ricerca in agricoltura e l'analisi dell'economia agraria – CREA-ZA, Italy; <sup>3</sup> Sport turf consulting, Italy

### INTRODUCTION

The innovative use of unmanned aerial vehicles (UAVs) in agriculture has opened new possibilities for crop monitoring. Flights of UAVs equipped with digital cameras can be easily scheduled in order to acquire crop spectral information in the visible and near-infrared regions at different times of crop development. Thereafter, vegetation indices (VIs) can be calculated and used to estimate the within-field variability of crop status (e.g. canopy N concentration). In a perspective of precision farming aimed at maximizing fertilizer-N use efficiency, integrating this information in a decision support system for crop fertilization, or directly estimating N supply rates based on spectral properties of the canopy, requires reliable predictions of spatial variability of crop yield and N uptake (Diacono et al., 2013). We present the results of a one-year field experiment designed to test the performances of two optical VIs for predicting winter-wheat yield and N uptake.

### MATERIAL AND METHODS

The experiment was conducted in 2016 in a field of 11 ha located in Sant'Agnes Lodigiano, Italy (45°13'31.4"N, 9°25'35.8"E). The field was sown in autumn 2015 with winter wheat (*Triticum aestivum* L., cultivar Basmati). On January 2016, the field surface was scanned using a multi-frequency EMI sensor Profiler-EMP400 (Geophysical Survey Systems Inc.), and three homogeneous areas (*i.e.* areas having low intra-variability and high inter-variability) were identified based on soil electric conductivity. Within each area, we measured wheat response to N fertilization using three increasing N rates: 0 (N0), 70 (N1) and 140 kg N ha<sup>-1</sup> (N2). Treatments were replicated three times and arranged in a completely randomized block design. Fertilizer addition was split in two top-dressing events: 36% of total N was supplied as NH<sub>4</sub>NO<sub>3</sub> on 13 February, and 64% as urea on 18 March. Fertilizers were surface-spread by hand on plots. The remainder of the field was fertilized at 140 kg N ha<sup>-1</sup>, according to farm practice. Plants were sampled (0.5 m<sup>2</sup> plot<sup>-1</sup>) on 17 March, 5 and 29 April, corresponding to BBCH growth stages 25, 31 and 45, respectively. Wheat was harvested at maturity (BBCH 99) using a Claas Lexion 570 harvester equipped with a Trimble yield monitoring sensor (Claas KGaA mbH) that provided a grain yield map (5 m × 5 m grid) of the whole field. The same days of plant sampling, we acquired multispectral images of the field using a MicaSense RedEdge™ camera (MicaSense Inc.) mounted on an unmanned coaxial octocopter. After radiometric calibration and image stitching (Pix4D software), the normalized difference vegetation indices based on the red (NDVI) and red-edge (NDRE) bands were calculated. Linear-plateau models were used to predict with the two VIs, wheat N uptake at the three sampling dates (using measurements taken in plots) and final grain yield (using estimates provided by the harvester for the whole field). One-way ANOVAs were performed, separately for each area and date, to test the statistical effect of N rate on N uptake.

### RESULTS AND DISCUSSION

Wheat responded positively to N fertilization in all areas and in all sampling dates (Figure 1a). However, differences in N uptake were marked and significant ( $P < 0.05$ ) only between N2 compared to N0. On average, N uptake was clearly lower in area 3 compared to others (not tested for significance with ANOVA), suggesting that factors other than N, further limited crop development in this area (likely a limited water availability as a consequence of a light texture and low organic matter content).

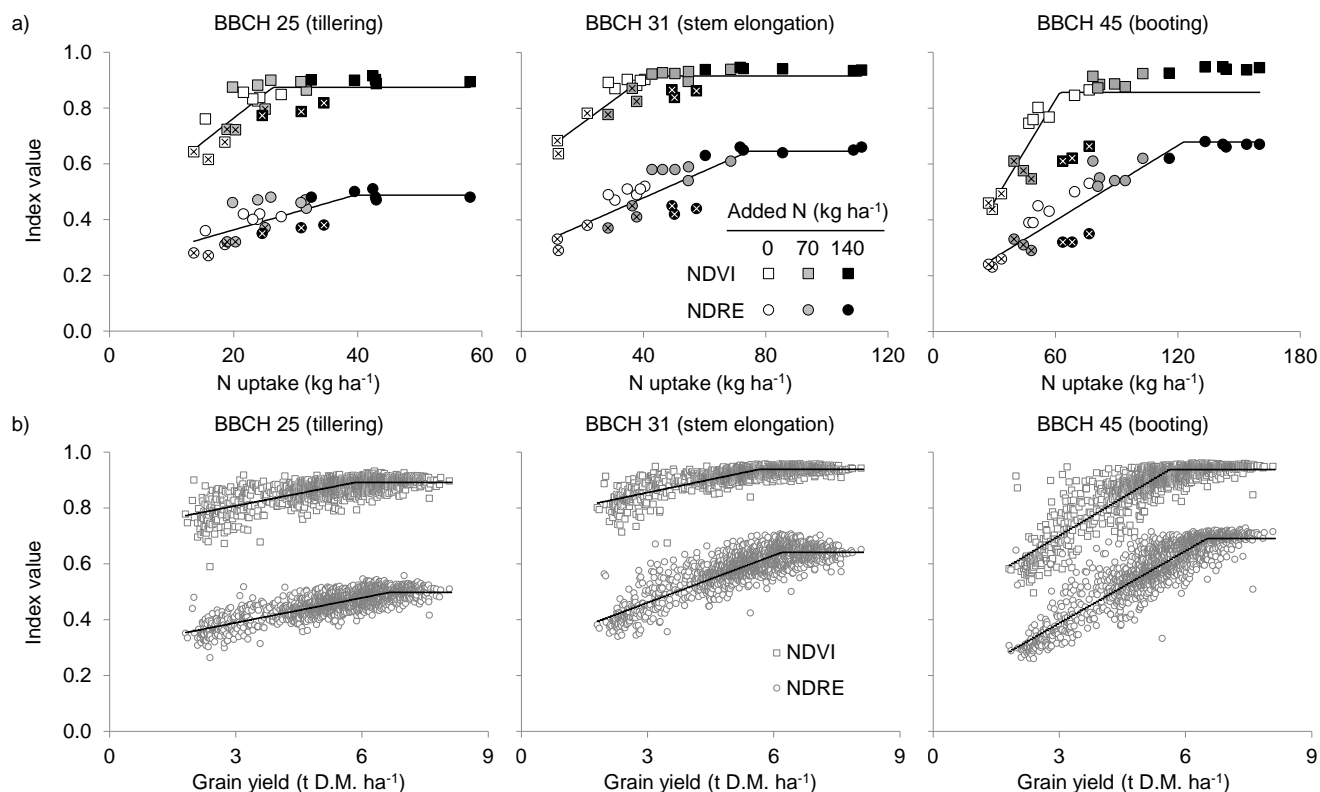

Figure 1. Relationship between VIs and plant N uptake measured in experimental plots (a) and grain yield measured in the whole field (b). Continuous black line: model fit using a linear-plateau model; symbol "x": plots belonging to area 3.

Regressions between VIs and N uptake (Figure 1a) and grain yield (Figure 1b) were satisfactorily modelled with linear-plateau functions, as confirmed by low Relative Root Mean Squared Errors in the range 4-12% for N uptake and 3-8% for grain yield. Plateaus of NDRE-based models occurred at higher N uptake or grain yield levels compared to those based on NDVI. The larger range of linearity in the response for NDRE suggests its use for N uptake estimation instead of NDVI. This consideration is further supported by considering that variability obtained in plots (VIs in Figure 1a) was higher than that observed at field level (VIs in Figure 1b in the range of those of N2 in Figure 1a), because the entire field was fertilized at the same N2 rate. Therefore, N uptake measured in N2 plots (Figure 1a) belonged to a linear-response range for NDRE, while for most of NDVI-based models it belonged to the flat response range, especially at earlier crop growth stages (BBCH 25 and 31).

## CONCLUSION

This experiment demonstrated that VIs could be satisfactorily used to predict early-mid season wheat N uptake and final grain yield. However, regression models obtained in this study require additional validation in order to get more robust estimations of model parameters. Thereafter, model predictions of early-mid season wheat N uptake can be used to feed decision support systems for crop fertilization. Alternatively, robust statistical models can be directly used to predict final grain yield, and thus calculate the amount of fertilizer N required.

## REFERENCES

Diacono M., Rubino P., Montemurro F., 2013. Precision nitrogen management of wheat. A review. *Agron. Sustain. Dev.*, 33, 219-241.

## EFFECT OF MODIFYING ROOT DISTRIBUTION ON GROWTH OF WHEAT AND NET NITROGEN BUDGETS

BUCKINGHAM S, JONES S, CRAWFORD C, BINGHAM I J

SRUC, West Mains Road, Edinburgh, UK

### INTRODUCTION

Temporary net nitrogen (N) immobilisation by soil microbes, driven by carbon (C) deposition from crop roots, is considered to contribute to the poor recovery of applied fertilizer N in UK wheat production systems. Improved understanding of N transformations and their response to soil C additions will help optimise N use efficiencies. The objective was to determine the scope for modifying root distribution between topsoil and subsoil to reduce N immobilisation without reducing N uptake. A split-root technique was used to vary the number of seminal root axes in the topsoil and subsoil.

### MATERIALS AND METHODS

Topsoil and subsoil was collected following spring barley harvest at Boghall Farm (Edinburgh, Scotland). Soils were sieved (4mm) and packed into adjoining PVC conduits to a bulk density of 1.2 g cm<sup>3</sup>. Topsoil (30 x 7.2 x 4.0 cm) and subsoil (30 x 9.7 x 5.8 cm) conduit dimensions represented a realistic soil volume to plant ratio based on a typical density of 330 spring wheat plants/m<sup>2</sup> and a topsoil and subsoil depth of 30 and 60 cm respectively. Spring wheat (cv Tybalt) seedlings were planted into the subsoil compartment following germination (7 days prior to planting). Seminal roots were guided manually into the topsoil through a small hole (9mm in diameter and 1cm in length) between the subsoil and topsoil compartments to give treatments of 0, 1, 2, 3, 4 and 5 seminal roots in the top soil, with the remainder of roots in the subsoil compartment. Plants were grown in a controlled environment chamber set to 16 hours light (20°C, 80% relative humidity) and 8 hours dark (15°C, 60% humidity). Soil moisture was maintained at 20% and 18% field capacity for top- and sub-soil respectively. All topsoil compartments received 25kg SO<sub>3</sub>/ha applied as K<sub>2</sub>SO<sub>4</sub> and plants received two foliar applications of Mn. Nitrogen was applied as ammonium nitrate to the topsoil (no N added to the subsoil) at a rate equivalent to 130 kg N/ha with a third being applied at the 2-3 leaf stage (unlabelled N) and two thirds injected uniformly throughout the topsoil as <sup>15</sup>NH<sub>4</sub><sup>15</sup>NO<sub>3</sub> at flag leaf emergence. Half of the replicated treatments were deconstructed 30 minutes after <sup>15</sup>NH<sub>4</sub><sup>15</sup>NO<sub>3</sub> injection (T0) with the second half of replicates deconstructed 14 days after <sup>15</sup>NH<sub>4</sub><sup>15</sup>NO<sub>3</sub> application at anthesis (T100).

### RESULTS AND DISCUSSION

Figure 1 shows little difference in shoot dry-weight at anthesis between treatments with one or more seminal roots in the topsoil demonstrating that providing there is at least one seminal root present the overall growth of spring wheat can be sustained. However, shoot growth was reduced by more than 50% when there were no roots in the topsoil (R0) and plants relied solely on subsoil conditions and nutrient supplies.

Root dry weight in the top soil at anthesis increased with increasing seminal root number up to treatment R0 (P<0.05 Figure 2a) but differences in root length across topsoil treatments were smaller (P>0.05 Figure 2b). Increases in lateral root branching led to increases in root length and, to a lesser extent, root DW per seminal root when numbers in the topsoil were low. Topsoil roots appeared to respond to nutrient deficiencies of the subsoil through compensatory adjustments in growth. The adjustments were largely established before the <sup>15</sup>N fertilizer was applied. As a result, the initial variation in seminal root distribution had little effect on <sup>15</sup>N uptake from the top soil or N immobilisation.

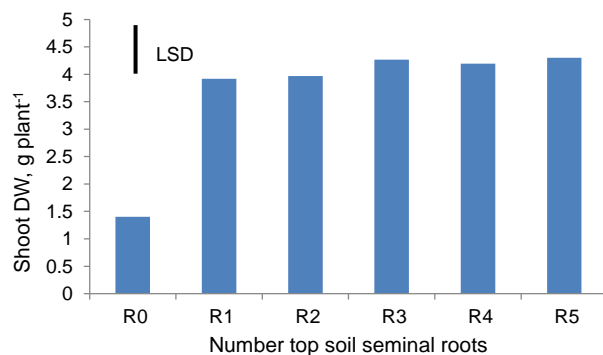

Figure 1. Spring wheat dry weight across treatments of 0 to 5 seminal roots in the topsoil

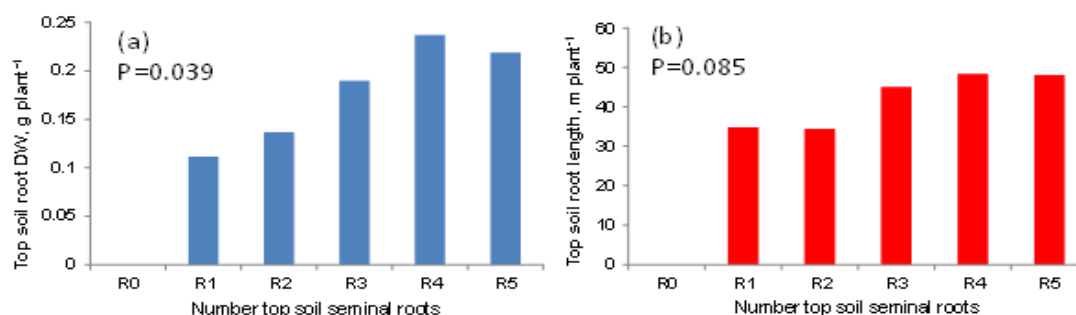

Figure 2a and 2b. Topsoil root dry-weight (a) and root length (b) in relation to treatments (R0 to R5)

## CONCLUSION

Preliminary results suggest that due to the plasticity of root systems, there may be relatively little scope for reducing root length density to any significant extent in the topsoil by modifying the distribution of seminal roots. There was no evidence of any significant immobilisation using soil mineral N and N uptake measurements. The N depletion from the nitrate pool between T0 and T100 was equivalent to the N uptake by plants in all treatments except the zero root treatment. Fertilizer uptake (<sup>15</sup>N) was less than total N uptake indicating that other sources of N were captured, which may be because the <sup>15</sup>N fertilizer was diluted by the soil nitrate pool at the time of application. There was little difference in percent recovery at T0 and T100 which shows that further loss of <sup>15</sup>N did not occur between T0 and T100. As a consequence opportunities for increasing fertilizer N recovery by reducing rhizodeposition of C and N immobilisation by this means may be limited.

**Acknowledgements:** This study was conducted as part of Work Package 2 activities in BBSRC funded project N-Circle.

## COMPOUND-SPECIFIC $^{15}\text{N}$ STABLE ISOTOPE PROBING TO PROVIDE NOVEL INSIGHTS INTO THE RESPONSE OF BACTERIAL AND FUNGAL COMMUNITIES IN SOIL TO FERTILISER

REAY, M.K.<sup>1</sup>, JONES, D.L.<sup>2</sup>, EVERSLED, R.P.<sup>1</sup>

<sup>1</sup>Organic Geochemistry Unit, University of Bristol, UK; <sup>2</sup> Environment Centre Wales, University of Bangor, UK

### INTRODUCTION

Organic nitrogen (ON) concentrations tend to exceed the inorganic N pool in soils by an order of magnitude, yet nitrogen cycling in this complex pool is poorly understood.  $^{15}\text{N}$  compound-specific stable isotope probing (SIP) techniques have been used to improve the understanding of N-cycling by tracing  $^{15}\text{N}$ -additions through the active microbial community using amino acids (Charteris *et al.*, 2016). This work has provided vital insights into the incorporation of inorganic fertiliser into ON in soil at the molecular level. However, amino acids are ubiquitous to all soil organisms therefore it is not possible to differentiate between bacterial and fungal assimilation of fertiliser using compound-specific stable isotope analysis (CSIA) of  $^{15}\text{N}$ -enriched amino acids.

Amino sugars (AS) are the second largest defined pool of ON in soils (5 to 12 %). It is possible to separate the  $^{15}\text{N}$ -immobilisation dynamics of fungal and bacterial pools due to the different origins of AS and elucidate their relative contributions in N utilisation (He *et al.*, 2011). This offers an insight into the roles different soil microorganisms play in the soil N-cycle as they occupy different ecological niches. Therefore, the application of a novel GC-C-IRMS method for the analysis of  $^{15}\text{N}$ -enriched amino sugars, as described here, provides the opportunity to differentiate between microbial responses of bacteria and fungi to inorganic fertiliser.

### MATERIAL AND METHODS

#### Incubations

Laboratory incubations were carried out by Charteris *et al.* (2016). In short, soil, sampled from the Rowden Moor Experimental Site (Devon, UK), was homogenised and adjusted to 50 % water holding capacity (WHC). Soil microcosms (10 g soil) under aerobic conditions were treated with 10 atom %  $^{15}\text{N}$ -ammonium chloride ( $^{15}\text{NH}_4\text{Cl}$ , 190 kg N ha<sup>-1</sup> yr<sup>-1</sup>),  $^{15}\text{N}$ -potassium nitrate ( $\text{K}^{15}\text{NO}_3$ ; 100 kg N ha<sup>-1</sup> yr<sup>-1</sup>) or DDW (for control samples). Incubations were carried out in triplicate and halted after incubation at 20°C over 32 days, frozen and freeze-dried.

#### Extraction, isolation and derivatization of hydrolysable amino sugars

Freeze-dried incubation soil samples (400 mg) were acid hydrolysed under  $\text{N}_2$  and *N*-methylglucamine added as an internal standard (IS). Soil hydrolysates were collected under centrifugation and amino sugars were isolated using cation-exchange chromatography. AS were then converted to their alditol acetate derivatives in a method adapted from Whiton *et al.* (1985).

#### Instrumental Analyses

Bulk soil  $\delta^{15}\text{N}$  analyses were carried out at the Lancaster Node of the NERC LSMSF (Charteris *et al.*, 2016). Quantification of individual amino sugars as their alditol acetate derivatives were carried out using gas chromatography, by comparison to the IS. The  $\delta^{15}\text{N}$  values of individual alditol acetate derivatives of AS were determined using GC-C-IRMS.  $\delta^{15}\text{N}$  values were determined relative to that of a monitoring gas of known isotopic composition and instrument performance was monitored using in-house AS standards which bracketed each sample.

### RESULTS AND DISCUSSION

Bulk soil  $\delta^{15}\text{N}$  values determined in Charteris *et al.* (2016) indicated an initial increase following  $^{15}\text{N}$ -addition but subsequently remained relatively constant for the remainder of the incubation, with high percentage retention.

This demonstrates the limitations of bulk N determinations to detect the mechanisms and mediators of processing of  $^{15}\text{N}$ -addition in soil. Likewise, determinations of hydrolysable amino acid (HAA) concentrations showed no significant changes during incubation. However, compound-specific  $^{15}\text{N}$ -AA analyses allowed the assimilation of added fertilizer-N to be traced quantitatively into the newly synthesized protein pool. Here, for the first time, assimilation of different N fertilizer into the soil ON pool was quantitatively assessed.

In this new work we now consider the partitioning of substrate N between the bacterial and fungal pools. This has required the development of a new analytical approach to allow the determination of  $^{15}\text{N}$  individual amino sugars. The modified alditol acetate approach offers advantages over the existing methods (aldonitrile) by avoiding the use of a derivative that introduces exogenous N into the amino sugars during sample preparation. Using both CSIA of amino acids and amino sugars we will provide insights into both the biochemical routing of  $^{15}\text{N}$  following assimilation of inorganic fertilizer and differing  $^{15}\text{N}$ -immobilisation dynamics within the microbial pool. The hypothesis is that the bacterial community will initially outcompete fungi in the assimilation of applied  $^{15}\text{N}$  inorganic fertiliser; however, fungi will dominate assimilation of  $^{15}\text{N}$  later in the incubation period. This will be reflected by rapid  $^{15}\text{N}$ -incorporation into muramic acid (MurN found in peptidoglycan) as will bacterial derived glucosamine (GluN). The bacterial and fungal derived GluN can be separated using known ratios (He *et al.*, 2011) and the fungal derived GluN will exhibit slower  $^{15}\text{N}$ -assimilation.

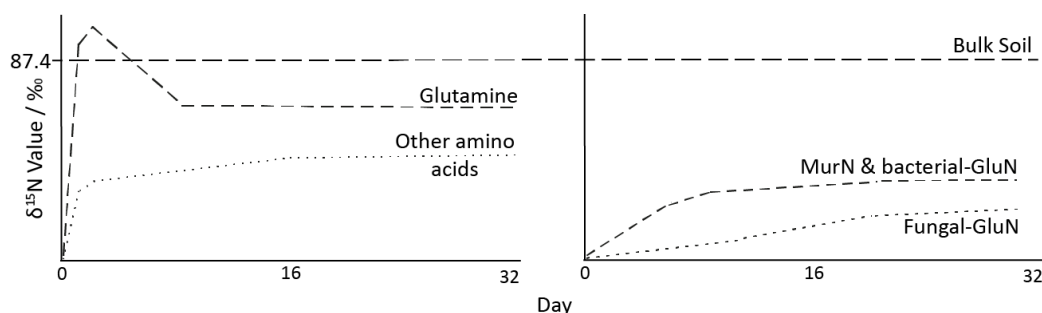

Figure 1

Figure 1: Hypothetical  $\delta^{15}\text{N}$  values of amino acids (LHS) and amino sugars (RHS) relative to the bulk soil  $\delta^{15}\text{N}$  resulting from incubation with  $^{15}\text{N}$ -fertiliser.

## CONCLUSION

We will describe a new CSIA approach to investigate dynamics of  $^{15}\text{N}$ -assimilation within the microbial pool. The development of the CSIA  $^{15}\text{N}$ -SIP approach for amino sugars will provide insights into the different temporal response of bacteria and fungi to fertiliser application. Combined, this investigates the dynamics of the active microbial community at a molecular level for the two largest defined N pools present in soil.

**Acknowledgements:** Soil incubations were carried out during A.F. Charteris' UK NERC Open CASE PhD studentship (NE/J017523/1). We thank NERC for partial funding of the mass spectrometry facility at Bristol (Contract No. R8/H10/63) and the UK NERC LSMSF (Lancaster node; H. Grant) for bulk soil N isotopic analysis.

## REFERENCES

- Charteris, A. F., Knowles, T. D. J., Michaelides, K. and Evershed, R. P., 2016. RCM, 30, 1846–1856.  
 He, H., Zhang, W., Zhang, X., Xie, H. and Zhuang, J., 2011. Soil Biol. Biochem., 43, 1155–1161.  
 Whiton, R. S., Lau, P., Morgan, S. L., Gilbert, J. and Fox, A., 1985. J. Chromatogr. A., 347, 109–120.



## **LONG TERM EFFECT OF NPK AND MANURE FERTILISATION AND CROP/GRASS ROTATIONS ON SOIL C AND N AND PLANT N CONCENTRATIONS**

PALMBORG, C.<sup>1</sup>, CARLSSON, G.<sup>2</sup>, ALBERTSSON, J.<sup>2</sup> JENSEN, E.S.<sup>2</sup>

<sup>1</sup> Department of Agricultural Research for Northern Sweden, Swedish University of Agricultural Sciences, Umeå Sweden; <sup>2</sup> Department of Biosystems and Technology, Swedish University of Agricultural Sciences, Alnarp, Sweden

### **INTRODUCTION**

Cultivation of perennial crops such as grass-clover leys and use of animal manure have been suggested as general measures to enhance carbon sequestration in soil, which have many benefits for the cropping system and society such as greater yields, reduced need for fertilizers, mitigation of climate change and enhancing adaption to climate change. In Umeå, northern Sweden, a long-term experiment (LTE) where fertilization and crop rotation are separate factors has been conducted since 1965. This LTE makes it possible to determine both fertilization and crop rotation effects on soil C and N storage as well as plant N, unlike most Swedish long-term experiments where the use of animal manure is restricted to treatments with perennial ley in the crop rotation.

### **MATERIAL AND METHODS**

The Umeå site has silty soil. It is a former wetland and the C content at the start of the LTE was 5.3%. From 1965 to 2010, the six crops: grass/clover ley (GC), barley, fodder rape, potatoes, annual ryegrass and oats, were either grown in monocultures or in crop rotations. There were two six-years rotations: Mixed rotation (reference): barley undersown with two years GC ley- fodder rape- potatoes- annual ryegrass and Long ley rotation: barley undersown with five years GC ley. There was also one three years rotation: Short grain rotation: barley- barley- oats. There were two replicate plots of each treatment and six replicate plots of reference rotation where each crop was represented in one plot every year. The GC ley was harvested twice per year, annual ryegrass three times per year and the other crops once per year. There were also three different fertilization treatments as sub-plots in a split plot design: Low NPK, which replaced nutrient removal in the harvests, High NPK = twice the Low NPK dose and Solid cattle manure+NPK- 10 tonnes per ha of cattle manure+ complementary NPK to reach the total amounts of nutrients added in Low NPK. Soil tillage management was conventional plowing and harrowing. Results presented here focus on soil C and N changes (2010 vs 1965) and possible treatment effects on plant N content for short GC ley and annual ryegrass (2002-2003).

### **Sampling and analysis**

Top-soil samples (0-20 cm) from all treatments in 2010, that had been stored dry, were milled in rolling bottles with steel rods after removal of visible roots. Four randomly selected samples of top soil from 1965 were also analysed since another analysis method for soil C was used at that time. The homogenised samples were analysed for %C and %N with an elemental analyser (DeltaV, Thermo Fisher Scientific, Bremen, Germany). Dry stored plant samples from the first harvest 2001-2006 of grass/clover and annual ryegrass were ball milled to a fine powder and analysed for %N at the same mass spectrometer. All statistical analyses were made in NCSS 8 (Hintze 2012) and details are given in the results sections.

### **RESULTS AND DISCUSSION**

#### **Nitrogen and carbon concentration in soil**

All treatments had lower top soil C and N concentrations in 2010 compared to 1965 (soil N content in figure 1). The soil data were analysed by General Linear Model ANOVA. Fertilization was considered a random factor, Crop rotation a fixed factor, and their interaction was included in the model. There were no significant differences between fertilization treatments in the final top soil C or N, thus the cattle manure addition had no effect on carbon sequestration. Thus, to avoid pseudo-replication, the means of the three fertilisation treatments were

calculated and used for further analysis with one way ANOVA. Long term ley had significantly higher soil %C ( $p=0.038$ ) and %N ( $p=0.022$ ) than all other crop rotations. It was noted that Monoculture barley and Short grain rotation had amongst the lowest treatment means of soil %N although they were not significantly different from the other rotations with annual crops (Figure 1).

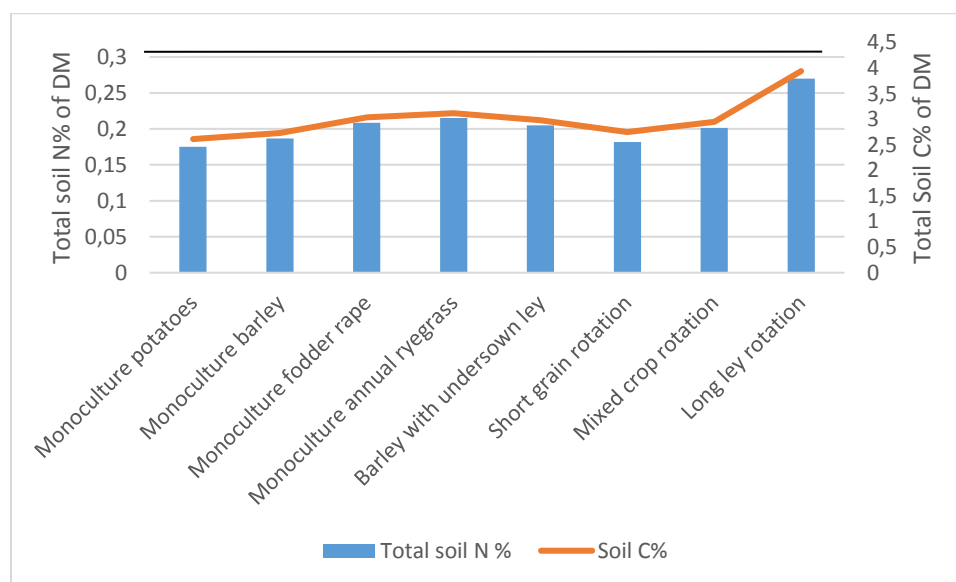

Figure 1. Topsoil nitrogen and carbon after 45 years of monocultures or mixed crop rotations. Means of all fertilization treatments. The line at the top represents the mean %N in 1965 at the start of the experiment.

### Effect of crop rotations and fertilisation on nitrogen content of grass-clover ley

The GC ley in the Long ley rotation was established in 2001, and thus directly comparable to the two year GC ley in the Mixed crop rotation in 2002 and 2003. Separate analysis was made for these years. There was a significant effect of fertilization ( $p=0.004$ ) and year but no significant differences between crop rotations although there were differences in soil %C and %N between crop rotations. The High NPK treatment resulted in 2.08%N in the GC ley, higher than in the Low NPK treatment (1.74% N) but not significantly higher than the Manure+NPK treatment (1.79%N). There were no significant differences due to fertilization treatment in the annual ryegrass monoculture crop.

### CONCLUSION

At the Umeå site which had high soil C and N concentrations at the start of the experiment, a Long ley rotation with barley undersown with grass-clover ley renewed every six years prevented about half of the decrease of the soil C and N concentrations compared to pure grain crop rotations or annual ryegrass. However this did not affect plant N content that was more dependent on the NPK-fertilization.

**Acknowledgements:** This study was made possible by the SITES Research station Röbbäcksdalen that is partly financed by the Swedish Research Council. The study was financed by Formas within the ERA-net project Climate CAFE (Formas project number 155-2014-1744).

### REFERENCES

Hintze, J. (2012). NCSS 8, NCSS, LLC, Kaysville, Utah USA.

## CLIMATE AND MANAGEMENT EFFECTS ON N<sub>2</sub>O EMISSIONS FROM TWO CROP SITES IN THE SOUTHWESTERN FRANCE

BIGAIGNON, L.<sup>1</sup>, LE DANTEC, V.<sup>1</sup>, ZAWILSKI, B.<sup>1</sup>, GRANOUILLAC, F.<sup>1</sup>, CLAVERIE, N.<sup>1</sup>, BRUT, A.<sup>1</sup>, CESCHIA, E.<sup>1</sup>, MORDELET, P.<sup>1</sup>, TALLEC, T.<sup>1</sup>

<sup>1</sup> Centre d'Etudes Spatiales de la BIOSphère (CESBIO), France

### INTRODUCTION

Nitrous oxide (N<sub>2</sub>O) is an important greenhouse gas (GHG) with a high global warming potential, around 300-fold higher than CO<sub>2</sub> for an approximate residence time of 120 years in the atmosphere (IPCC, 2013). Agricultural soils represent the highest anthropogenic source of N<sub>2</sub>O emissions due to bacterial degradation of nitrogen fertilizers. In France, 51% of agricultural GHG emissions are related to N<sub>2</sub>O emissions. In the context of global change, the objective is twofold: to satisfy food production to meet the growing demography needs and to reduce the environmental footprint of agricultural practice for a sustainable agriculture. N<sub>2</sub>O emissions are related to physico-chemical parameters which depend on climate (temperature, rain...), soil texture (Robertson et al., 1989) and farming practices (irrigation, tillage, fertilizer type and quantity...) (Tellez-Rio et al., 2015). Given this context, it is essential to evaluate climatic variability and management interaction effects on N<sub>2</sub>O fluxes in using long time series of flux measurements to highlight practices producing low N<sub>2</sub>O emissions. In this on-going project we propose to analyze the effects of climate and contrasted management on N<sub>2</sub>O fluxes monitored for five years over two crop sites in the south-west of France.

### MATERIAL AND METHODS

#### Sites description

N<sub>2</sub>O flux measurement were carried out between 2012 and 2016 on two crop sites near Toulouse in the South-West of France, Lamasquère (FR-Lam) and Auradé (FR-Aur). Both sites are part of the European research infrastructure consortium ICOS (Integrated Carbon Observation System) and of the Regional Spatial Observatory (OSR). The mean annual rain and air temperature are 680 mm and 12,6°C respectively. Both sites experience similar meteorological conditions but have different management, soil properties and topography. FR-Lam site is flat with a high water table depth. At FR-Aur site, there is a gentle slope (2%) with a very low water table depth. The FR-Aur plot belongs to a cereal production farm (only grain is exported), whereas the FR-Lam plot belongs to a dairy farm (all aboveground biomass is exported). Only mineral fertilization is applied at FR-Aur, whereas at FR-Lam both mineral and organic fertilizers are applied. Crop rotations on both sites are representative of the main regional crop rotations: winter wheat – irrigated maize at FR-Lam; wheat – rapeseed – sunflower – winter wheat at FR-Aur. The soil is classified as clayey at FR-Lam site and as clay-loam at FR-Aur site.

#### Chamber methodology for N<sub>2</sub>O flux measurement

On each site, flux measurements were performed using a set of 6 closed automated chambers (70cm x 23cm x 10cm) coupled to an infrared gas analyzer, the Thermofisher Scientific 46i (relative accuracy of ± 20 ppb). The set up allowed measuring the potential N<sub>2</sub>O accumulation during 17.5 minutes four times a day every 6 hours (00:00, 06:00, 12:00, 18:00 UTC) inside each chamber alternatively. N<sub>2</sub>O fluxes (gN.ha<sup>-1</sup>.day<sup>-1</sup>) were then calculated following Tallec et al. (submitted). The data were fitted with an exponential rise regression model.

#### Soil variable measurement

Soil water content and temperature were measured at 0-7 cm depth at hourly step using a probe (ThetaProbe, ML2x, Delta-T Devices Ltd., UK) and T107 captors (Campbell Scientific Ltd., UK) respectively.

### RESULTS AND DISCUSSION

The preliminary results highlighted that N<sub>2</sub>O fluxes followed a clear seasonal dynamic related to WFPS, soil temperature and potential mineral nitrogen availability dynamics (data not shown). In the year 2012, a large peak of N<sub>2</sub>O emissions (higher than 150 g N-N<sub>2</sub>O ha<sup>-1</sup> day<sup>-1</sup>) appeared consecutively to a heavy rain event (87 mm in 4 days) between 19 and 22 May 2012 (Figure 1), which increased WFPS from 46 ± 8 % to more than 65 ± 11 % (data not shown). At the same time, high amount of nitrate was available following spring mineralization (data not shown). N<sub>2</sub>O fluxes remained high from 22 May to 2 June, with mean emissions of 114 g N-N<sub>2</sub>O ha<sup>-1</sup> day<sup>-1</sup>. Slurry application on 7 September led to an immediate peak of N<sub>2</sub>O emission, reaching a maximum of about 220 g N-N<sub>2</sub>O ha<sup>-1</sup> day<sup>-1</sup> that lasted no more than six days. Despite the positive effect of irrigation on the WFPS between mid-July and mid-August, N<sub>2</sub>O fluxes remained mostly low, probably because of reduced mineral nitrogen availability combined with lower soil temperature than in May (data not shown). Background emissions observed and calculated from 10 to 21 May and from 4 to 7 July achieved a mean value of 13.3 ± 1.6 g N<sub>2</sub>O-N ha<sup>-1</sup> day<sup>-1</sup> (Figure 1). The study is still in process and the future work on other years would allow analysing in details respective effect of climate and management on N<sub>2</sub>O fluxes. At this stage, we would expect less N<sub>2</sub>O emissions at FR-Aur than at FR-Lam site partly due to split application of nitrogen fertilizer and the water table depth difference.

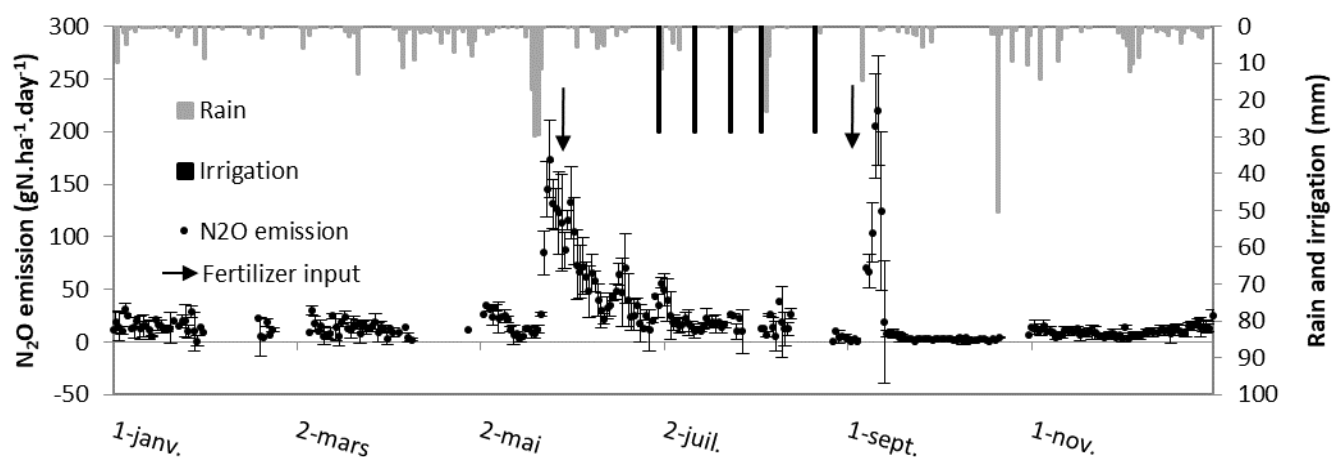

Figure 5. Daily dynamic of N<sub>2</sub>O emissions from a maize crop at FR-Lam site during the year 2012: sowing on 27 April, harvest on 23 August, fertilizer: 110 kg N.ha<sup>-1</sup> on 30 May and 120 kg N.ha<sup>-1</sup> as manure on 4 September.

## CONCLUSION

The long time series of N<sub>2</sub>O fluxes measured for five years on two contrasted cropping system offer the unique opportunity to better understand and determine impact of environmental variables, themselves modulated by climate variability, soil properties, topography and agricultural practices, on soil GHG emissions in the southwestern France. This ongoing project is expected to highlight the agricultural practices which could reduce N<sub>2</sub>O emissions.

## REFERENCES

- IPCC, 2013. Climate Change 2013: The Physical Science Basis. Cambridge University Press, Cambridge.
- Robertson et al., 1989. Aerobic denitrification in various heterotrophic nitrifiers. *Antonie van Leeuwenhoek.*, 56, 289-299.
- Talleg et al., N<sub>2</sub>O flux measurements over an irrigated maize crop: a comparison of three methods. Submitted to *Agr. Forest Meteorol.*
- Tellez-Rio et al., 2015. N<sub>2</sub>O and CH<sub>4</sub> Emissions from a Fallow-wheat Rotation with Low N Input in Conservation and Conventional Tillage under a Mediterranean Agroecosystem. *Sci. Total Environ.*, 508, 85-94.

## ANALYZING AND MODELING THE VARIABILITY OF SOIL ORGANIC NITROGEN MINERALIZATION FROM FIVE YEARS OF FIELD MEASUREMENTS

BEFF, L.<sup>1</sup>, LAMBERT, Y.<sup>2</sup>, GERMAIN, P.<sup>1</sup>, LOUIS, B.<sup>3</sup>, MARY, B.<sup>4</sup>, BEAUDOIN, N.<sup>4</sup>, MORVAN, T.<sup>1</sup>

<sup>1</sup> UMR SAS, AGROCAMPUS OUEST, INRA 35000 Rennes, France ; <sup>2</sup> Chambre d'agriculture de Bretagne, Rennes, France ; <sup>3</sup> Statisticien indépendant, Beaumont, France ; <sup>4</sup> INRA, UR1158 Agro-Impact, Laon, France

### INTRODUCTION

Optimizing nitrogen (N) fertilization requires correctly predicting the amount of N resulting from soil organic N mineralization, crop usable, which can vary greatly depending on climatic conditions, soil properties and cropping system. While many studies were realized to evaluate the impact of soil properties, soil temperature or water content, few studies integrated the cropping system. We therefore conducted field experiments during five years in Brittany to study the effect of this three factors and especially the cropping system on soil N mineralization, and propose a predictive model.

### MATERIAL AND METHODS

Experiments were performed for five years (2010-2014) on 67 maize cultivated fields located throughout Brittany, France. The fields were chosen to cover a wide range of soil types under different management systems (crop rotation and manure supply) and climatic conditions. Soil net N mineralization ( $Mn$ ) was calculated from mineral N mass-balance:  $Mn = Nf - Ni + N_{uptake} + N_{leached}$ , with: (i)  $Nf - Ni$  corresponding to the difference in soil mineral (0-90 cm) N content at the end,  $Nf$ , (October) and at the beginning,  $Ni$ , (March) of the mass-balance period ( $\text{kg N ha}^{-1}$ ); (ii)  $N_{uptake}$  corresponding to N uptake by the plant ( $\text{kg N ha}^{-1}$ ); (iii)  $N_{leached}$  corresponding to nitrate leaching that occurs in spring, after  $Ni$  measurement ( $\text{kg N ha}^{-1}$ ) and was estimated using the STICS model (Brisson et al., 2008). We extracted the effect of climate on mineralization by converting calendar time into normalized time ( $tn$ ). We used the functions described by Brisson et al. (2008) to model effects of temperature and soil water content on N mineralization.  $Mn$  was normalized by dividing it by  $tn$  for each year and field, which gives a daily 'normalized' rate of mineralization,  $Vn$  ( $\text{kg N ha}^{-1} \text{tn}^{-1}$ ). Because fields were unfertilized, without input of fresh organic matter and bare soil during winter, we assumed that  $Mn$  corresponds to mineralization of stable organic N for the three last years of experiment, i.e. after stabilization of the system. With this assumption, we are allowed to suppose that  $Vn$  was similar for the three last measurement years, for a given field, and therefore equaled the potential N mineralization rate of the soil.

The soil of the upper layer (0-30 cm) was sampled in March 2013 to estimate some soil properties (e.g. texture, C and N content, CEC, pH), microbial biomass and an indicator of mineralization with a phosphate-borate buffer,  $EON$  (Gianello and Bremner, 1988). An indicator of the cropping system ( $I\_Sys$ ) was calculated to estimate effects of field management (crop rotation and manure application) on N mineralization for the 15 years before the beginning of the experiment.  $I\_Sys$  was calculated by summing (i) N return to the soil by plants and (ii) effects of repeated manure applications in the middle term. To assess impacts of  $I\_Sys$  on N mass balance and soil N mineralization, we classified its values into three levels using the K-means method: low ( $\leq 67 \text{ kg N ha}^{-1}$ ), moderate ( $67-104 \text{ kg N ha}^{-1}$ ) and high ( $> 104 \text{ kg N ha}^{-1}$ ).

### RESULTS AND DISCUSSION

Mean  $Mn$  from March to October equaled 162, 146 and 154  $\text{kg N ha}^{-1}$  in 2012, 2013 and 2014, respectively.  $Mn$  was thus relatively similar in all three years. The level of  $I\_Sys$  had a significant effect on the **3 years averaged values** of  $N_{uptake}$ ,  $Mn$  and  $Vn$  ( $P < 0.01$ ). We also observed a significant effect of  $I\_Sys$  on the **annual average values** of  $Vn$  ( $P < 0.05$ ) (Figure 1a).

$Vn$  allows for comparison of soil N mineralization between years and fields and therefore highlights effects of the

cropping history and soil properties on soil N mineralization. The averaged  $Vn$  values for the 3 years ( $Vn_{mean}$ ) was highly correlated with  $EON$  ( $r=0.48$ ,  $P<0.001$ ), microbial biomass ( $r=0.45$ ,  $P<0.001$ ) and  $I\_Sys$  ( $r=0.39$ ,  $P<0.001$ ). The significant and positive correlation between  $Vn_{mean}$  and  $I\_Sys$  confirms and highlights the need to take into account effects of cropping system at a middle-term scale (15 years in the current study). However, individual correlations are not sufficiently high to satisfactorily explain the variability in  $Vn$  for this dataset.

We then applied Kruskal-Wallis test to identify the fields for which we could accept the hypothesis of equal values of  $Vn$ , for the 3 years. This hypothesis was accepted for 43 fields ( $P<0.05$ ), allowing us to consider that  $tn$  explained well the N mineralization variability between the 3 years, for these fields. We then considered that  $Vn_{mean}$  corresponded to the best estimate of the mineralization of the field, and the modeling approach was developed on this subset of 43 fields. The variable and their form (linear, quadratic or polynomial of degree 2 or 3) were selected by the minimization of the MSEP for a GAM model (Wood 2006). The selected variables were  $EON$ , microbial biomass,  $I\_Sys$ , clay, coarse sand, coarse silt. Because  $EON$  and microbial biomass were the two variables that correlated best with  $Vn_{mean}$  and were poorly correlated between them, they gave complementary information. The predictive quality of the model ( $r^2=0.71$ ) was quite comparable to the performance of the best models found in the literature (Figure 1b).

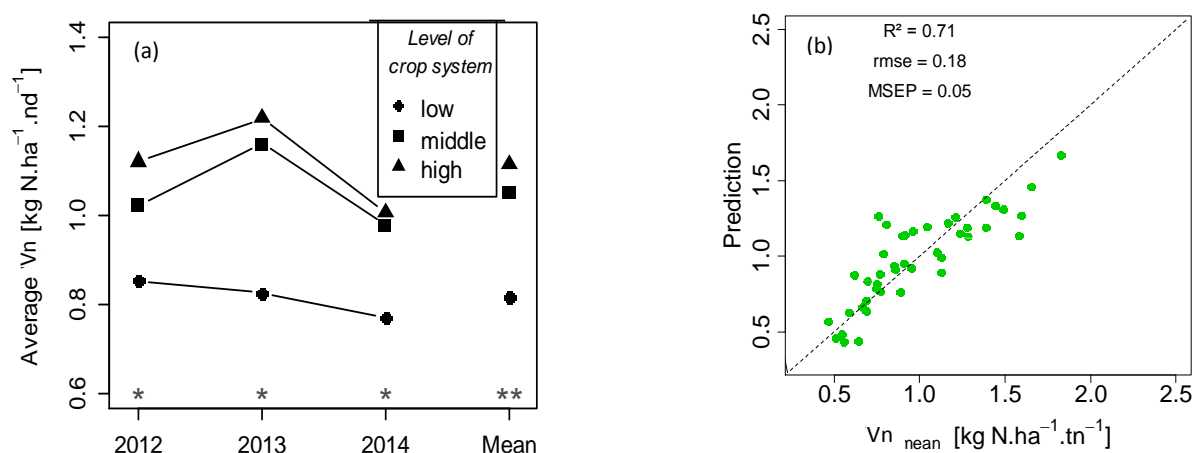

Figure 1: (a) Effect of the level of  $I\_Sys$  on  $Vn$ . The data were averaged for the fields belonging to the same crop level by year and for all the 3 years (mean). Significance of the level of crop system obtain with Kruskal-Walis test is given at the bottom of each subplot with “\*” for  $p$ .value  $< 0.05$ , “\*\*\*” for  $p$ .value  $< 0.01$ . (b) Comparison of  $Vn_{mean}$  and that predicted by the model for the 43 fields. The dashed line indicates the 1:1 line.

## CONCLUSION

With five years field measurements, we evaluated the variability of soil N mineralization and highlight the importance of the cropping system on this variability. For that, we developed an indicator of the cropping system. This indicator combined with an  $EON$  indicator, microbial biomass and soil texture allowed an accurate prediction of the normalized soil N mineralization rate ( $Vn$ ) for the Brittany region.

**Acknowledgements:** This work was financially supported by AELB, CRB, DRAAF, CG 22, CG 29 and CG 56.

## REFERENCES

- Brisson, N., Launay, M., Mary, B., Beaudoin, N., 2008. Conceptual Basis, Formalisations and Parameterization of the STICS Crop Model. INRA, Rd 10, 78026 Versailles Cedex, France, Editions Quae.
- Gianello, C., Bremner, J. M., 1988. A rapid steam distillation method of assessing potentially available organic nitrogen in soil. Communications in Soil Science and Plant Analysis, 19(14): 1551-1568.
- Wood, S. N., 2006. Generalized additive models: an introduction with R. Boca Raton, Florida, U. S. A., Chapman.

## ESTIMATION OF DELAYED EFFECT OF SOME ORGANIC MATTER TYPES ON SUGARCANE

FEVRIER A.<sup>1</sup>, PAILLAT J.<sup>1</sup>, MARION D.<sup>1,2</sup>

<sup>1</sup> eRcane, Réunion Island; <sup>2</sup> CIRAD, Réunion Island

### INTRODUCTION

Sugarcane production is mainly dependent on mineral fertilization in Reunion Island. At the same time, the territory is producing more and more organic residues which can be use as organic fertilizers for sugarcane. However, Reunion, is in a sub-tropical area, with great pedo-climatic diversity, and there is little information available on the dynamics of this organic matter in this context. TERO project aims to study the nitrogen efficiency of diverse organic matters from Reunion Island by estimating N Apparent Use Efficiency (AUC) and performing foliar diagnosis for different organic materials, and distinguishing their direct and delayed effects.

### MATERIAL AND METHODS

TERO Project is located at several sites, and is a long term experiment (4 trials) on Reunion Island which started in 2014. The first results come from one location, La Mare, Sainte-Marie. 6 organic matter types are tested with 3 repetitions. 3 modalities of organic matter were applied:

Table 4: Organic matter modalities

Modalities	Treatments	Application
1	75 % of nitrogen requirement (soil analysis and Serdaf* recommendation each year)	Each 2 or 3 years
2	37,5 % of nitrogen requirement (soil analysis and Serdaf* recommendation each year)	Each 2 or 3 years
3	75 % of nitrogen requirement (soil analysis and Serdaf* recommendation for the planting year)	Every year

\*Serdaf (expert system for fertilization) is a tool for fertilization advice in sugarcane crop at Réunion Island.

### Organic matter modalities

Pork manure is applied every year. Filter mud, green waste compost, are applied every three years, poultry litter, Camp Pierrot compost (mixed with poultry litter and pig manure) and pellets of sewage sludge are applied every two years.

### Mineral modalities

5 mineral modalities are used to determine a nitrogen response curve. The need of sugarcane (x) is determined by Serdaf. The mineral modalities are 0x; 0,5x; 0,75x; 0,9x and 1,5x.

This mineral modalities are used to calculate AUC of urea and organic matter.

### Nitrogen measurement

Using the NIRS method, the nitrogen rate is determined in the leaf at 6, 8 and 10 months after planting or harvesting and the nitrogen content in entire aerial part sugarcane is determined by chemical analysis at harvest.

### RESULTS AND DISCUSSION

After 2 growing cycles, at the first location of the project, the first delayed effects are observed in two types of observations, the foliar diagnosis and the AUC.

### Foliar diagnosis shows a delayed effect similar to Apparent Use Efficiency

Extreme mineral fertilization are included in the tables of interpretation of leaf diagnosis (Fillols and Chabalier, 2007). Therefore the values of zero and 150% of fertilization are used as reference for the results.

As expected, organic matter applied every two years has a low delayed effect. Only sewage sludge of the first modality has a better FD than the modality without mineral fertilization. The response of AUC is nul for all modalities apart from the first modality of sewage sludge, with 0.05 (NS) AUC, the year without input, and 0,14 the year with application. More than 50% of N is in the form of  $\text{NH}_4^+$  for Camp Pierrot compost, 33% for poultry litter, while only 10% in pellet sewage sludge, which can explain why a delayed effect was observed for this product.

For organic matter applied every three years, the foliar diagnosis suggests a stronger delayed effect than AUC. Filter mud (modality 1) has a similar rate of nitrogen uptake as mineral modality with 150% of nitrogen requirement, at 6 months (respectively 15,8% and 15,9%) and 8 months (respectively 13,4% et 13,7%) of analysis. At 10 months the rate is slightly lower for filter mud (respectively 11,2% and 12,6%). However, AUC is 0 for the first modality and 0,08 for the second modality. This result is the outcome of an underestimation of equivalence factors. Organic nitrogen is dominant in filter mud, which is why the expected delayed effect is observed.

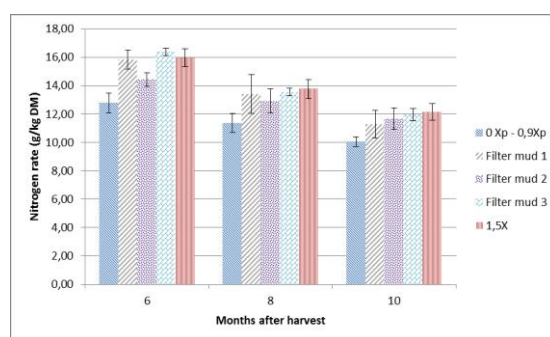
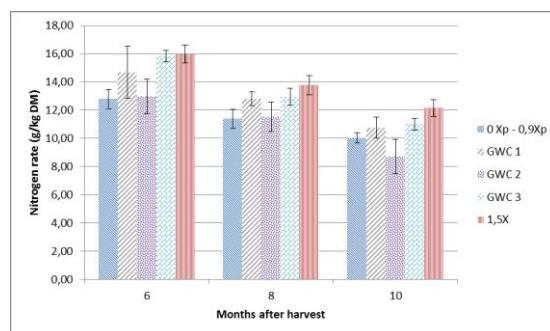

Fig1: Nitrogen rate obtained by FD in first ratoon for filter mud

Composts are more stable than raw organic matter and have a good amending value and a lower fertilizer value (Flavel et al 2006, Houot et al 2016). Nitrogen content in compost is in the organic form (90%), so mineral nitrogen content depends on mineralization rate. FD and AUC show this indirect effect of fertilization. At 6 and 8 months, the nitrogen rate is similar between green waste compost (modality 1) and the mineral modality with 150% of nitrogen requirement. At 10 months, the nitrogen rate decreases between these two extremes. At harvest, the apparent utilization coefficient is 0.03. This includes compost application of the previous year, which is half of the AUC of the current year of application.





*Fig 2: Nitrogen rate obtained by FD in first ratoon for green waste compost (GWC)*

### **CONCLUSION**

After 2 years of fertilization, the first delayed effects are shown by foliar diagnosis, especially with organic matter containing more organic nitrogen, like filter mud and green waste compost.

### **REFERENCES**

- Fillois E, Chabaliere P.F, 2007. Guide de la fertilisation de la canne à sucre à la Réunion. CIRAD, CTICS. 166p.
- Flavel T.C, Murphy D.V, 2006, Carbon and Nitrogen Mineralization Rates after Application of Organic Amendments to soil. *Journal of environmental quality* 35: 183-193.
- Houot S., Pons M.-N., Pradel M, Tibi A, 2016. Recyclage de déchets organiques en agriculture. Edition Quae. 199p

## **A NOVEL PLATFORM TO PROVIDE SERVICES IN THE MONITORING OF GREENHOUSE GASES FOR AGRICULTURAL SYSTEMS**

DECUQ, C.<sup>1</sup>, GENERMONT, S.<sup>1</sup>, LOUBET, B.<sup>1</sup>, CELLIER, C.<sup>1</sup>, GABRIELLE, B.<sup>1</sup>

<sup>1</sup> UMR EcoSys;INRA; AgroParisTech, Université Paris-Saclay, France

### **INTRODUCTION**

Mitigating future climate changes, likely to result in increasing damages from droughts, tornados, typhoons or extreme precipitation events warrants a detailed knowledge of the emissions of greenhouse gases (GHG) originating from various economic sectors. Assessing the contribution of agriculture to climate change is one of the key questions that environmental scientists have to address in order to identify possible measures to reduce the burden of agriculture on global warming. Solutions to reduce these emissions exist but are less well quantified than in other sectors due to the large variability of GHG exchanges over time and space. Building on its 20 years of experience in quantifying and predicting biosphere-atmosphere exchanges of GHGs, the ECOSYS research unit (INRA and AgroParisTech) is now able to propose a commercial offer for the environmental assessment of agricultural systems, directed at academic research, agricultural extension services, agro-chemical companies or government agencies overseeing agriculture and environmental management. Applications of the novel platform of INRA Transfer at ECOSYS include the evaluation of, among others: (a) the GHG balance of agricultural practices (b) the potential solutions for reducing GHG emissions (c) the potential emissions from chemical or organic fertilizers and their dynamics. This paper details the types of measurements and monitoring that this platform can deliver, and showcases some of the results obtained in past programmes, and their use for evaluation and decision-making processes.

### **MATERIAL AND METHODS**

#### **Measurement of GHG concentrations and fluxes**

At the core of its new offer of services, the ECOSYS Research Unit in Grignon (40 kms West of Paris) set up a GHG analysis platform to quantify GHG concentrations in air samples such as N<sub>2</sub>O, CH<sub>4</sub>, CO<sub>2</sub> and SF<sub>6</sub> by gas chromatography. The preparation of sampling vials, a critical step in the process of field air sampling is included in the services provided by the platform. Emissions of GHG from cropping systems may be directly measured in field trials using static chambers (Rochette et al., 2008). The surface area covered by the chamber was 0.25 m<sup>2</sup> while the chamber height above the soil surface was 0.2 m. Air is sampled from the chambers's headspace using sampling vials put into vacuum beforehand. GHG concentrations are quantified by gas chromatography equipped with double detection: an Electron Capture Detector (ECD) and a flame ionization detector (FID). The simultaneous measurement of N<sub>2</sub>O, CH<sub>4</sub>, CO<sub>2</sub> is an original feature of the analysis chain, which makes it possible to detect leaks in chambers. Gas concentrations were used to calculate fluxes making a linear regression of GHG concentrations as a function of the different sampling times. Measurement steps from the «sample tube preparation» to «GHG concentration determination» are quality-insured. The “ECOSYS GHG analysis platform” has validated analysis methods following french normalisation (NF V03-110, 2010). The uncertainties of measurements on each gas concentration are determined.

#### **Two cropping systems examples**

To illustrate the use of this platform for scientific research, we report on a PhD project aiming at assessing the potential of cropping systems design to mitigate GHG emissions (Goglio et al., 2013). N<sub>2</sub>O emissions were monitored on two cropping systems set up in Grignon: (a) a reference system (referred to as PHEP), aiming at reaching altogether High Environmental Performances and Productivity, while being representative of arable systems in the region, and (b) a cropping system aiming at halving greenhouse gas emissions compared with the reference system (referred to “low emissions system GHG”). This system seeks to increase C sequestration in the

soil and decrease N<sub>2</sub>O emissions. GHG emissions were measured every week after fertilizer N inputs, also depending on rainfall events, and every month otherwise. An agro-ecosystem model was used to simulate the emissions and interpolate them over time. (Gabrielle et al., 2006)

## RESULTS AND DISCUSSION

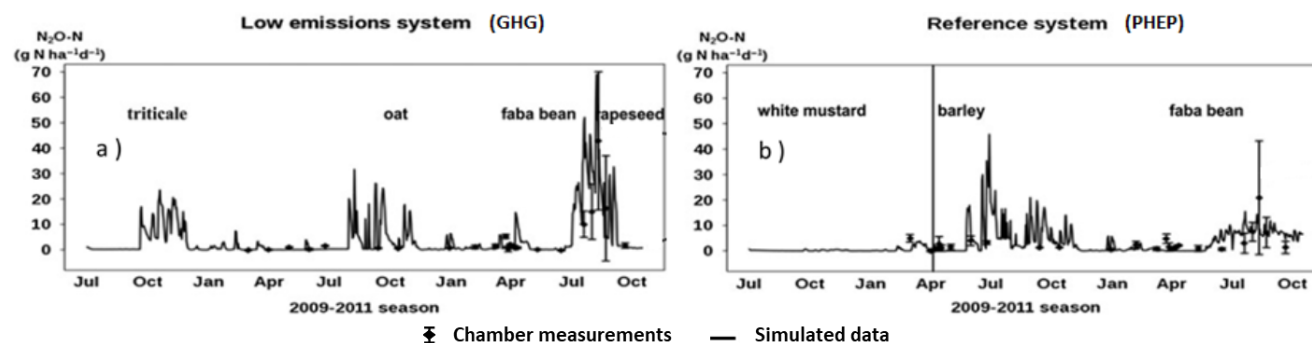

Figure 1. Simulated and observed N<sub>2</sub>O emissions for the (a) low emissions system and (b) reference cropping system (Vertical lines: date of fertiliser application, error bars: 95 % confidence interval for observed data). (Goglio et al., 2013)

Overall, N<sub>2</sub>O emissions were of relatively low magnitude over the 2 years of measurement, being under 10 g N<sub>2</sub>O-N ha<sup>-1</sup> day<sup>-1</sup>. Spikes above this level were recorded following the harvest of faba bean in the fall of 2011, with similar ranges across the two cropping systems. The model could capture the variations of N<sub>2</sub>O emissions whether on a seasonal or daily basis, with a mean deviation under 1 g N<sub>2</sub>O-N ha<sup>-1</sup> day<sup>-1</sup> and a root mean squared error around 5 g N<sub>2</sub>O-N ha<sup>-1</sup> day<sup>-1</sup>. The average cumulative N<sub>2</sub>O emissions from the 50%GHG system was 28.5% lower than the reference PHEP system. This ratio is lower than the 50% abatement target assigned to the former system, but does not factor in the differences in soil C sequestration potentials between these systems, which was later confirmed. When taking each crop separately, the highest emissions occurred with faba beans in the reference system (amounting to 1500 g N<sub>2</sub>O-N ha<sup>-1</sup>), while the least-emitting crop was winter wheat in the 50% GHG system (totalling 291 g N<sub>2</sub>O-N ha<sup>-1</sup>; Goglio et al., 2013).

## CONCLUSION

The novel service platform set up by ECOSYS is now ready to deliver high-quality measurements of GHG exchanges for a wide range of agricultural systems, and potential applications. It is expected to facilitate GHG monitoring and assessments in various contexts and its services may be readily customized according to the user's needs and objectives.

**Acknowledgements:** The authors are grateful to Pietro Goglio (Cranfield U., UK). Financial support from INRA, Agroparitech, FIRE, and Terres Inovia is also acknowledged. Romain Cresson (INRA Transfert) is the manager of the commercial unit and leads the transfer process.

## REFERENCES

- Rochette P, Eriksen-Hamel NS (2008) Chamber Measurements of Soil Nitrous Oxide Flux: Are 24 Absolute Values Reliable? *Soil Science Society of America Journal* 72: 331–342. doi:10.2136/sssaj2007.0215
- Goglio, P., Colnenne-David, C., Laville, P., Doré, T., Gabrielle, B., 2013. 29 % N<sub>2</sub>O emission reduction from a modelled low-greenhouse gas cropping system during 2009-2011. *Environmental Chemistry Letters*, 11, 143-149.
- Gabrielle, B.; Laville, P.; Hénault, C.; Nicoulaud, B. & Germon, J. C. Simulation of nitrous oxide emissions from wheat-cropped soils using CERES Nutrient Cycling Agroecosys., 2006, 74, 133-146

## COMPARING AMMONIA VOLATILISATION OF LIVESTOCK EFFLUENTS HAVING UNDERGONE DIFFERENT TREATMENTS IN FIELD CONDITIONS

VOYLOKOV, P.<sup>1</sup>, LOUBET, B.<sup>1</sup>, HOUOT, S.<sup>1</sup>, SAVOIE, A.<sup>2</sup>, GENERMONT, S.<sup>1</sup>

<sup>1</sup> UMR EcoSys, INRA, France <sup>2</sup> INRA UEPAO, FRANCE

### INTRODUCTION

The study presented here is part of the MetaMetha project, designed to evaluate the impact of including an anaerobic digestion step in manure treatment on C and N cycles in agriculture [see Savoie et al., this workshop]. The series of experiments undertaken in the spring and summer of 2017 sought to compare nitrogen use efficiency NUE for a range of treated and raw digestates and non-digested manure and slurry as well as conventional mineral fertiliser applied to crops. NUE is diminished both due to volatilisation as NH<sub>3</sub> and N<sub>2</sub>O or leaching which have adverse effects on the environment and also constitute a loss of fertiliser and potentially yield for the farmers.

A novel method of gaseous emission measurement based on the inversion of the FIDES model (Loubet et al, 2017) [see Loubet et al., in the side event] and the use of passive ammonia samplers (ALPHA, Tang et al., 2001) was implemented to quantify the ammonia emission fluxes. This method indeed is convenient for this sort of experiment where numerous treatments are applied to small parcels. The experimental site was over-equipped in the objective to tests assumptions made for the calculations, and to undertake an analysis of the method performed on this set of data.

### MATERIAL AND METHODS

The experiment took place from March 2017 to August 2017 on 5 experimental plots located in Nouzilly near a biogas plant (INRA, Centre-Val de Loire region, France). There were three fertiliser application events (2017/03/22, 2017/04/19 and 2017/08/02). During the first two events, four treatments were applied to parcels of about 1800 m<sup>2</sup> each, with an additional parcel serving as a control with no treatments. The treatments were bovine slurry, a mineral fertiliser, a raw digestate obtained after the anaerobic digestion of various organic products including pig, cow and horse effluents and the separated liquid fraction of the same digestate. During the last application event, the treatments were a bovine manure, the solid fraction of the same digestate and the raw digestate, likewise with a control treatment.

The parcels were divided into three sections serving as replicates and each section contained a mast with passive sensors (ALPHA badges) attached at different heights. During the first experiment, a setup of 1 to 3 sensor heights was tested. During the remaining two, each section had sensors at two heights. Samplers measured integrated concentrations over periods ranging from several hours just after application to several days at the end of the volatilisation event. The badges were analysed using the FloRRia analyser. Raw micrometeorological data collected using a Gill sonic anemometer, was processed using LabView and EddyPro software in order to obtain the necessary parameters used to calculate the transfer resistance of each sensor/parcel using the FIDES model. This model is based on a semi-analytical solution of the advection-diffusion equation in the surface layer. The sources are subdivided into grid cells each contributing to the observed concentration at the measurement heights. These transfer resistances were used along with concentrations in order to calculate instantaneous ammonia flux from each parcel by least square inference (QR decomposition). Using this data, a sensitivity analysis to several FIDES parameters was performed. The resolution (mesh size) was tested as well as choice of the lateral dispersion function sigma Y (according to Sutton, BNL or Briggs), minimum Monin-Obukhov length, minimum roughness length, and the number of sensors used.

## RESULTS AND DISCUSSION

Raw digestate tended to have the highest ammonia losses followed by liquid digestate, and slurry for the first two experiments. During the third stage, solid manure, solid digestate and raw digestate had significantly higher emissions than the control.

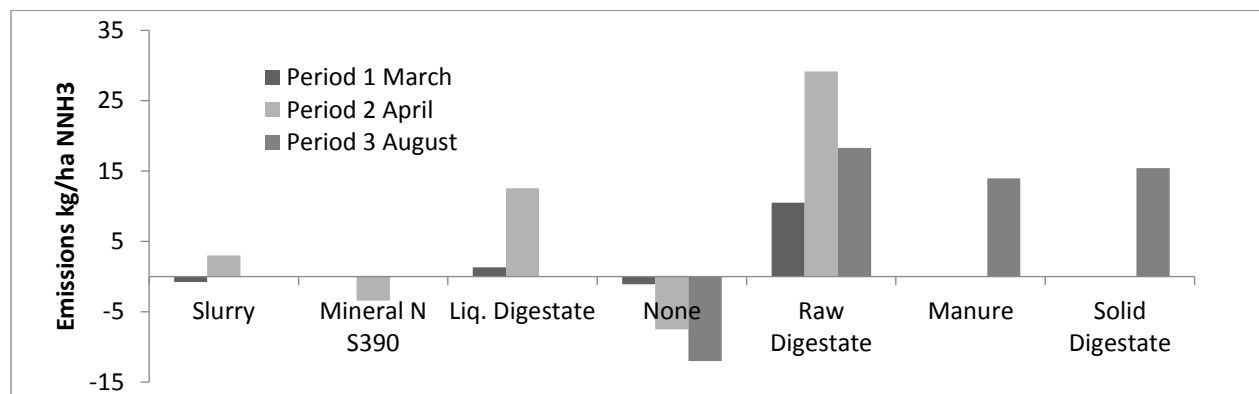

The sensitivity analysis has not yet been fully performed. The following ANOVA was performed on the results of the first period. These results were obtained, using 0.03 and 0.05 m as minimum roughness length, 1, 2 and 5 as min MO length, 0.5, 1, 2 and 5 m as mesh size and using sigma Y calculations according to Sutton, BNL and Briggs. The mesh size is of a particular interest as it would be helpful to know what the best resolution is given the parcel surface area. The minimum roughness length appears to be significant as well.

Analysis of Variance Table				Response:	Emissions kg ha <sup>-1</sup>
	Df	Sum Sq	Mean Sq	F value	Pr(>F)
Mesh	3	1.9	0.65	6.3897	0.0002999
Sigma	3	0.1	0.03	0.2584	0.8553095
Lmin	2	0	0.01	0.1309	0.8772953
z0min	1	0.9	0.9	8.8334	0.0031108
Treatment	4	8808.9	2202.22	21702.8178	<2.2E-16
Residuals	466	47.3	0.1		

## CONCLUSION

This method is well suited for the comparison of different treatments in the field and its deployment should help evaluate ammonia volatilization after slurry and manure as well as mineral fertilizer applications in various French agricultural contexts and elaborating strategies of reduction. Concerning the effect of the treatment process before application, treated manure gave higher ammonia emissions due to greater ammonia content. The N losses due to ammonia volatilization will be compiled in the global N budget calculations of the MetaMetha project.

**Acknowledgements:** The MetaMetha project, funded by Centre Val de Loire(conv. n° 2016 – 00108447). The authors warmly acknowledge intern A. Lemekhova, and the lab technicians B. Esnault, C. Decuq, E. Vachet and Y. Delaunay.

## REFERENCES

- Loubet, B., Carozzi, M., Voylokov, P., Cohan, J.-P., Trochard, R., and Générumont, S.: Evaluation of a new inference method for estimating ammonia volatilisation from multiple agronomic plots, *Biogeosciences Discuss.*, <https://doi.org/10.5194/bg-2017-424>, in review, 2017.
- Y.S. Tang, J.N. Cape, and M.A. Sutton, "Development and Types of Passive Samplers for Monitoring Atmospheric NO<sub>2</sub> and NH<sub>3</sub> Concentrations," *TheScientificWorldJOURNAL*, vol. 1, pp. 513-529, 2001.

## EFFECT OF UREASE AND NITRIFICATION INHIBITORS ON NITRIC AND NITROUS OXIDE EMISSIONS, AND YIELD IN AN IRRIGATED MAIZE CROP

RECIO, J.<sup>1,2</sup>, MONTOYA, M.<sup>1,2</sup>, GUARDIA, G.<sup>1,2</sup>, GINES, C.<sup>1,2</sup>, SANZ-COBEÑA, A.<sup>1,2</sup>, VALLEJO, A.<sup>1,2</sup>, ÁLVAREZ, JM.<sup>1,2</sup>

<sup>1</sup> ETSI Agronómica, Alimentaria y de Biosistemas, Universidad Politécnica de Madrid, Spain; <sup>2</sup> Research Center for the Management of Environmental and Agricultural Risks (CEIGRAM), Universidad Politécnica de Madrid, Spain

### INTRODUCTION

Reducing nitrogen (N) losses from agriculture is pivotal to lessen the environmental impacts associated to the application of organic and synthetic fertilizers. The use of nitrification (NI) and urease inhibitors (UI) has demonstrated the potential to decrease N losses to the atmosphere or groundwater. Apart from NIs commonly used, such as dicyandiamide (DCD) or 3,4-dimethylpyrazole phosphate (DMPP), there are still few studies to use the new NI 3,4-dimethylpyrazole succinic acid (DMPSA). On the other hand, UIs have demonstrated their efficiency to mitigate ammonia (NH<sub>3</sub>) and nitrous oxide (N<sub>2</sub>O). However, little is known about the effect of these inhibitors over both N<sub>2</sub>O and nitric oxides (NO) fluxes.

### MATERIAL AND METHODS

A field experiment was carried out at the field station “Center”, situated near Torrejon de Ardoz (Madrid, Spain), in order to compare the N<sub>2</sub>O and NO emissions from different fertilizer treatments. Fifteen plots (81 m<sup>2</sup>; 9 m x 9 m) sown with maize (*Zea Mays* L. FAO class 600) were arranged in a three-replicated randomized block design. Fertilizers were provided by EuroChem Agro<sup>®</sup> and were applied by hand at top-dressing (29<sup>th</sup> June 2017) with a rate of 200 kg total N ha<sup>-1</sup> for all treatments. The different fertilizer treatments were: 1) Urea (Urea), 2) Urea with DMPSA (U+NI); 3) Urea with the UI N-(n-butyl) thiophosphoric triamide (NBPT) (U+UI); 4) Urea + NBPT + DMPSA (U+2I); 5) Control with no N fertilization (Control)

### N<sub>2</sub>O sampling and analyses

During the first 45 days after fertilization (DAF), samples of gases were taken 2-3 times per week considering it is the most critical period of high gas emissions. Afterwards, the frequency of sampling was decreased progressively, increasing after rainfall events. The N<sub>2</sub>O fluxes were measured using the closed chamber technique (Sanz-Cobena et al., 2012) and their concentrations were quantified by gas chromatography.

### NO sampling and analyses

Nitric oxides were measured with an entirely automated laboratory measuring system over the cropping season of maize from June 29<sup>th</sup> to August 8<sup>th</sup>, 2017. The completely automated laboratory measuring system was designed and constructed following the method proposed by Butterbach-Bahl et al. (1997) with some modifications. The experimental set-up, schematically consisted of 16 flow dynamic chambers, a pump and a chemiluminescence NO- NO<sub>2</sub>- NOX analyser (model 42i Thermo Environmental Instruments Inc., USA). The opening time of the valves, the sequence of closure and re-opening chambers and data collection were controlled by a PC, running a specially developed computer program (SIMdas, DNOTA<sup>®</sup>, Spain). A full cycle takes 3 h to complete, resulting eight measurements per day and plot.

### Statistical methods

The statistical analysis of data was performed by using the R software. Analyses of variance were performed for NO and N<sub>2</sub>O cumulative emissions and grain yield among all treatments. Data distribution normality and variance uniformity were previously assessed. Averages were separated by LSD test at P < 0.05.

### RESULTS AND DISCUSSION

Cumulative N<sub>2</sub>O and NO emissions (Figure. 1) were significantly higher in urea treatment than in the rest of fertilized N treatments. Total NO emission decreased in the order: Urea > U+UI ≥ U+2I ≥ U+NI ≥ Control (P < 0.05). The effectiveness of NBPT abating NO losses (more than 40%) was close to has been supported by Sanz-Cobena et al. (2012) in an irrigated maize crop (an abatement of 67%). The DMPISA (U+NI) alone performed slightly better potential mitigation than DMPISA+NBPT (U+2I). Cumulative N<sub>2</sub>O emissions decreased in order: Urea > U+UI ≥ U+NI ≈ U+2I ≥ Control (P<0.05). In this case, DMPISA significantly decreased (more than 50%) cumulative N<sub>2</sub>O fluxes at the end of the experimental period. Guardia et al. (2018) reported similar efficacy of DMPISA in cumulative N<sub>2</sub>O emissions in maize, under similar soil and environmental conditions. Treatment of UI alone (U+UI) significantly mitigated the cumulative N<sub>2</sub>O emissions in comparison of urea.

Grain and biomass yield were significantly increased by the application of N fertilized treatments with respect to Control. Interestingly, the U+NI treatment produced an increase (not significantly) of grain and biomass yield in relation to Urea treatment. In addition, statistically similar grain and biomass yield was observed in treatments based on UI and U+2I treatment compared to urea and U+NI.

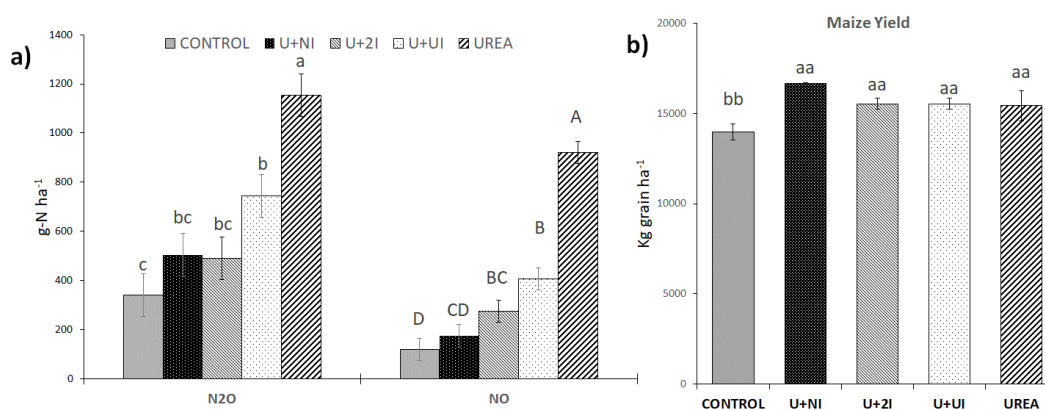

Figure 6: a) Total cumulative N<sub>2</sub>O-N and NO emissions in maize crop. b) Maize yield. Vertical bars indicate standard error and letters above bars indicate significant differences by applying the LSD test at P < 0.05

## CONCLUSION

The use of DMPISA, with or without NBPT, led to highest mitigation rates of no, n<sub>2</sub>o and yield-scaled n<sub>2</sub>o emissions. Despite the double inhibitor was not as effective as DMPISA in abatement nitric oxide emissions, the potential mitigation of this treatment (U+2i) is to mitigate not only N<sub>2</sub>O and no compared with urea alone, but also the reduction of ammonia volatilization and indirect N<sub>2</sub>O emissions.

## REFERENCES

- Butterbach-Bahl, K., Gasche, R., Breuer, L., Papen, H., 1997. Fluxes of NO and N<sub>2</sub>O from temperate forest soils: impact of forest type, N deposition and of liming on the NO and N<sub>2</sub>O emissions. *Nutr. Cycl. Agroecosystems* 48, 79–90.
- Guardia, G., Vallejo, A., Cardenas, L.M., Dixon, E.R., García-Marco, S., 2018. Fate of 15 N-labelled ammonium nitrate with or without the new nitrification inhibitor DMPISA in an irrigated maize crop. *Soil Biol. Biochem.* 116, 193–202.
- Sanz-Cobena, A., Sánchez-Martín, L., García-Torres, L., Vallejo, A., 2012. Gaseous emissions of N<sub>2</sub>O and NO and NO<sub>3</sub><sup>-</sup> leaching from urea applied with urease and nitrification inhibitors to a maize (*Zea mays*) crop. *Agric. Ecosyst. Environ.* 149, 64–73.

## HIGHER NITROGEN USE EFFICIENCY UNDER REDUCED TILLAGE

ERNFORS, M.<sup>1</sup>, JENSEN, ES.<sup>2</sup>.

<sup>1,2</sup> Department of Biosystems and technology, Swedish university of agricultural sciences, Sweden

### INTRODUCTION

Reduced tillage practices increase the carbon (C) content in the upper soil layer (Haddaway et al. 2017). Since C and nitrogen (N) cycles are closely coupled, an altered distribution of C may also affect the N turnover in the soil. It has been hypothesised that the higher soil organic matter content in the surface layers of reduced tillage soils could cause a higher initial immobilization of N fertilizer in the spring, restricting N availability for the crops, but also decreasing the risk of losses of N through leaching and denitrification. This hypothesis was confirmed by Couto-Vázquez and González-Prieto (2016), after 14-15 years of reduced tillage, but not by Giacomini et al. (2010), after 5 years of reduced tillage, or by Thomsen and Christensen (2007) in a study with less than 10 years of reduced tillage at most of the sites used. The hypothesis of the present study was that changes in N mineralization-immobilization turnover due to reduced tillage would be detectable in an 18-year-old field experiment, where an altered organic matter distribution has had time to develop.

### MATERIAL AND METHODS

The study was carried out within a long-term cropping systems field experiment at the SITES Lönnstorp Research Station in Sweden. The experiment had been running for 18 years at the start of the experiment and included conventionally tilled plots (plowed) and plots with reduced tillage (shallow non-inverting tillage). There were also some differences between the treatments in the six-year crop rotation. A one-year grass-clover ley and a faba bean crop in the reduced tillage system corresponded to cereal crops in the conventional system. There was also an oil radish cover crop before the sugar beet crop in the reduced tillage system. The tillage treatment plots contained response plots, with several nitrogen fertilization levels, that had been in place since the start of the experiment. Two of the levels in the N fertilisation sequence were used: one step above and one step below standard rates. N loss and plant N recovery were determined by applying an isotopically labelled fertilizer solution (5 at%  $^{15}\text{NO}_3^{15}\text{NH}_4$ ) in 2012 and measuring the recovery of the isotope in crop and soil in 2012, 2013 and 2014. Data was analyzed by two-way ANOVA, using SPSS software.

### RESULTS AND DISCUSSION

The crops in the reduced tillage treatment assimilated significantly more of the N fertilizer added in spring 2012, in the first year, compared to the same crops in the conventional tillage treatment (50% and 38 %, respectively). In 2013, an additional 2 and 5% of the N fertilizer added in 2012 were recovered in the crop, in the reduced tillage and conventional tillage treatments, respectively. In 2014, 1 % of the N from 2012 was recovered in each of the two treatments. Preliminary results show a higher total (soil + plant) recovery of labelled N over the period 2012-2014, in the reduced tillage treatment, and thus lower losses of fertilizer N. The higher crop uptake of fertilizer N in the reduced tillage system was associated with a higher total N uptake (Figure 1). This may have been either a cause or an effect of lower N losses. A seemingly more efficient use of N and a lower fertilizer N loss in the reduced tillage treatment point to positive effects on N cycling by reduced tillage. However, labelled N was added only in one year and variation between years can be large. The design of the field experiment as a systems experiment, with differences in more than one factor between the two treatments, also calls for a more cautious interpretation than in traditional factorial experiments. Additional analyses of collected samples will be carried out and final results will be presented at the workshop.



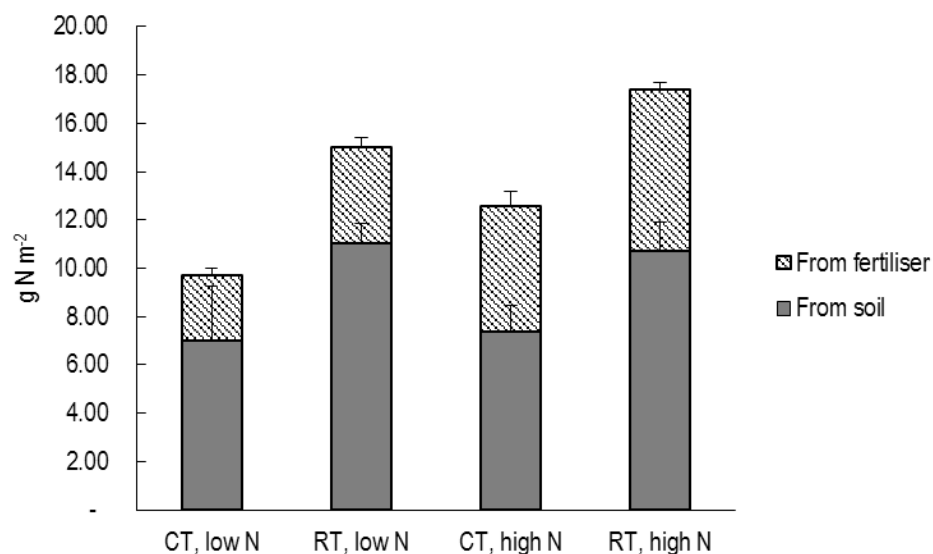

Figure 1. Crop N uptake from soil and fertilizer sources, in the same year as <sup>15</sup>N labelled fertilizer addition. RT = reduced tillage, CT = conventional tillage. Low N = below standard, High N = above standard.

## CONCLUSION

Reduced tillage may lead to a more efficient use of fertilizer N and a lower fertilizer N loss, compared to conventional tillage.

**Acknowledgements:** This study was made possible by the Swedish Infrastructure for Ecosystem Science (SITES), specifically the SITES Lönnstorp Research Station. The work was funded by FORMAS.

## REFERENCES

- Haddaway N.R., Hedlund K., Jackson L.E., Kätterer T., Lugato E., Thomsen I.K., Jørgensen H.B., Isberg P., 2017. How does tillage intensity affect soil organic carbon? A systematic review. *Environ. Evid.*, 6: 30.
- Couto-Vázquez A. and González-Prieto S.J., 2016. Fate of <sup>15</sup>N-fertilizers in the soil-plant system of a forage rotation under conservation and plough tillage. *Soil Tillage Res.*, 161: 10-18.
- Giacomini S.J., Machet J.M., Boizard H., Recous S., 2010. Dynamics and recovery of fertilizer <sup>15</sup>N in soil and winter wheat crop under minimum *versus* conventional tillage. *Soil Tillage Res.*, 108: 51-58.
- Thomsen I.K., and Christensen B.T., 2007. Fertilizer <sup>15</sup>N recovery in cereal crops and soil under shallow tillage. *Soil Tillage Res.*, 97: 117-121.

**N FERTILIZER FORMS AFFECT NITROUS OXIDE EMISSIONS IN A FERTIGATED POTATO SYSTEM**LEBENDER, U.<sup>1</sup>, TIERLING, J.<sup>1</sup>, BRUECK, H.<sup>1</sup><sup>1</sup> Research Centre Hanninghof, Yara GmbH & Co. KG, Germany**INTRODUCTION**

Nitrogen fertilizers are supposed to be a major source of nitrous oxide (N<sub>2</sub>O) emissions from arable soils. The N<sub>2</sub>O emitted originates mainly from microbial nitrogen pathways, the balance of which is affected by the application of N fertilizers (Robertson and Grace, 2004) or by irrigation regime, aside from natural factors. Agricultural practices that increase water and N use efficiency (NUE) are considered as potential N<sub>2</sub>O mitigation options (Smith et al., 2008). Drip fertigation is considered as one of the best management practices regarding water and NUE. Urea and calcium nitrate are very water-soluble, and thus their use in fertigation is widespread. Experiments in such systems comparing the effect of different N fertilizer types on N<sub>2</sub>O emissions within the same study are scarce.

**MATERIAL AND METHODS**

The study was carried out on a sandy soil in North-West Germany (51.832° N, 7.290° E). Potato was planted at a density of 3,9 tubers m<sup>-2</sup>. Three treatments were examined: (1) control without fertilizer application, (2) calcium nitrate (CN) and (3) urea, each at a total application rate of 250 kg N ha<sup>-1</sup>. Fertigation started around tuber bulking stage until mid of flowering stage with a total of 6 fertigation events. Static gas chambers were used including PVC collars. The collars were installed permanently in the ridge allowing the subsurface fertigation dripline to pass through. N<sub>2</sub>O emissions were measured with the closed chamber method on 39 occasions during the experimental period of 72 days. Emission rates were estimated with linear regression (de Klein and Harvey, 2015). Cumulative emissions were calculated with the trapezoidal integration method (de Klein and Harvey, 2015). Treatments were compared with ANOVA and Tukey's post-hoc tests. All calculations were performed with R 3.1.1 (R core team, 2015).

**RESULTS AND DISCUSSION**

Total N<sub>2</sub>O emissions from the urea treatment were almost twice those of the CN treatment (Table 1), which is similar to results found by Abalos et al. (2014) in a fertigated melon system.

*Table 1. Cumulative N<sub>2</sub>O emissions (gN ha<sup>-1</sup>), emission factors EF (in % of Total fertilizer applied) for various Nitrogen fertilizer forms.*

Treatment	Emission period	N amount (kg N ha <sup>-1</sup> )	Cumul. N <sub>2</sub> O (gN ha <sup>-1</sup> )	EF (%)
control	Pre-fertigation period	0	211.5	
	Fertigation period	0	178.5	
	Total experimental period	0	390.0	
CN	Pre-fertigation period	150	213.8	0.00
	Fertigation period	100	79.4	-0.10
	Total experimental period	250	293.2	-0.07
urea	Pre-fertigation period	150	390.9	0.12
	Fertigation period	100	257.3	0.08
	Total experimental period	250	652.2	0.10

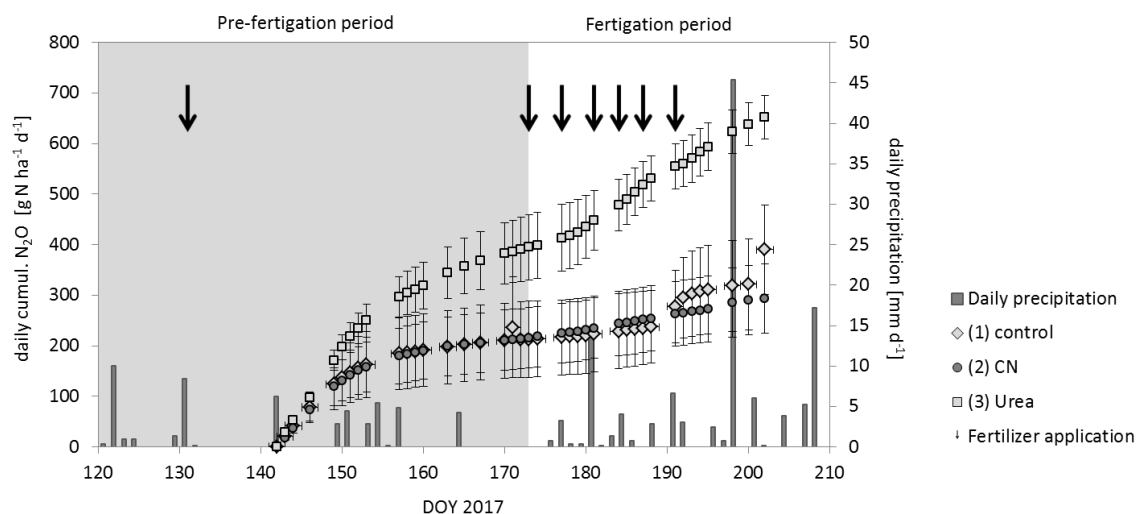

Figure 1: Cumulative daily nitrous oxide emission rates after the application of Nitrogen fertilizer either as calcium nitrate (CN) or urea in ridged potato cropping system. Plots show mean values  $\pm$  se ( $n=4$ ).

While almost no additional  $N_2O$  was detected in the CN compared to the control treatment,  $N_2O$  emissions were observed in the urea treatment during the whole measurement period (Fig. 1).

The injection of nitrogen to the soil during the fertigation events induced further  $N_2O$  emissions in the urea treatment while the CN treatment did not react at all (Fig.1), implying that nitrification was the prevailing  $N_2O$  producing process within the fertigated potato ridge. Comparing the pre-fertigation period with the fertigation period, broadcast fertilizer application resulted in 85% higher emissions compared to the fertigation period. This indicates that fertigation can serve as a mitigation option under arid to semiarid conditions.

## CONCLUSION

We conclude that in arid and semiarid climates fertigation of row crops like potato might be a useful strategy to mitigate  $N_2O$  emissions. Under non-denitrifying conditions the nitrification of fertilizers can play a major role regarding  $N_2O$  emissions, therefore the choice of N fertilizer form is highly important especially in consideration of climate change mitigation.

## REFERENCES

- Robertson, G.P., Grace, P.R., 2004. Greenhouse gas fluxes in tropical and temperate agriculture: the need for a full-cost accounting of global warming potentials. *Environ. Dev. Sustainability* 6, pp. 51–63.
- Smith, P., Martino, D., Cai, Z., Gwary, D., Janzen, H., Kumar, P., McCarl, B., Ogle, S., O'Mara, F., Rice, C., Scholes, B., Sirotenko, O., 2007. Agriculture. In *climate change 2007: mitigation*. In: Metz, O.R.D., Bosch, R. (Eds.), Fourth Assessment Report of the Intergovernmental Panel on Climate Change. Cambridge University Press, Cambridge, UK.
- de Klein, C. A. M., Harvey, M., 2015. Nitrous Oxide Chamber Methodology Guidelines. Ministry for Primary Industries, Wellington, New Zealand.
- R Core Team, 2015. R: A language and environment for statistical computing. R Foundation for Statistical Computing, Vienna, Austria. URL <http://www.R-project.org/>
- Abalos, D., Sanchez-Martin, L., Garcia-Torres, L., van Groenigen, J. W., Vallejo, A., 2014. Management of irrigation frequency and nitrogen fertilization to mitigate GHG and NO emissions from drip-fertigated crops. *Science of the Total Environment* 490, pp. 880-888.

## CONTRIBUTION OF ESCHERICHIA COLI FOR REDUCING GREENHOUSE GAS AND AMMONIA EMISSIONS FROM TREATED CATTLE-SLURRY LIQUID FRACTION

MIRANDA, C.<sup>1</sup>, SOARES, A.S.<sup>1</sup>, TEIXEIRA, C.A.<sup>1</sup>, COELHO A.C.<sup>2</sup>, TRINDADE, H.<sup>1</sup>

<sup>1</sup> Centre for the Research and Technology of Agro-Environmental and Biological Sciences (CITAB), Universidade de Trás-os-Montes e Alto Douro (UTAD), Portugal; <sup>2</sup> The Animal and Veterinary Research Centre (CECAV), UTAD, Vila Real, Portugal.

### INTRODUCTION

Slurry management poses serious environmental problems in dairy farming activities. On the one hand, slurry is a common organic fertilizer applied to grassland due to its rich composition in organic matter and nutrients, namely nitrogen. On the other hand, its degradation leads to greenhouse gas (GHG) emissions such as methane (CH<sub>4</sub>), carbon dioxide (CO<sub>2</sub>) and nitrous oxide (N<sub>2</sub>O) and ammonia (NH<sub>3</sub>) (Fangueiro et al., 2008). In addition, the direct deposition of cattle slurry to land causes pathogens transport from crop land to streams resulting in increased water contamination. Many pathogens like *Escherichia coli* (*E. coli*), *Salmonella* sp. and *Listeria monocytogenes*, which persist in soil, slurry, and water are a serious human health issue (Biswas et al., 2016). Although several studies have been performed to reduce gaseous emissions and mitigate pathogens from animal waste, it is unknown the impact of these pathogens on gaseous emissions during the management of slurry. This study was conducted to evaluate the influence of the *E. coli* presence in dairy slurry liquid fraction during storage conditions on GHG and NH<sub>3</sub> emissions.

### MATERIAL AND METHODS

The cattle slurry was obtained from a dairy farm in north of Portugal and subjected to mechanical separation by sieving, generating a solid and a liquid fraction (LF). The LF was stored in kilner jars filled with 1L of effluent and subjected to 5 different treatments in quadruplicate, including the application of biochar (4-5%), sulphuric acid (to pH=5.5) or beneficial microorganisms (Bm - bio buster®) and two controls. In the treatment with additives and in one of the two controls used, *E. coli* was inoculated (10<sup>9</sup> cfu/mL). During 90 days of storage at 20°C, samplings were carried out at different time intervals for gas measurements. For each measurement of GHG emissions, the jar was hermetically sealed by replacing the lid and the first gas sample was immediately taken and the followings after 10 min and 20 min of closure. Samples were flushed through evacuated 20 mL gas vials and analysed by gas chromatography (Fangueiro et al., 2015). To evaluate NH<sub>3</sub> emissions, ammonia fluxes were measured using acid traps containing 50 mL of 0.02M orthophosphoric acid. Acid solutions collected were analyzed for total ammonium N content by automated segmented-flow spectrophotometry (Houba et al., 1995). Data was statistically analysed for GHG and NH<sub>3</sub> fluxes and cumulative emissions, using the software STATISTIX 10 (Tallahassee, FL).

### RESULTS AND DISCUSSION

During the 3 months of slurry-storage, the cumulative emissions showed that most of the additives contributed to the reduction of GHG (CH<sub>4</sub> and CO<sub>2</sub>:  $p < 0.01$ ) and NH<sub>3</sub> ( $p = 0.04$ ) emissions. Comparing the results of the treatments with the slurry control without addition of *E. coli*, there was a decrease in NH<sub>3</sub>, N<sub>2</sub>O and CO<sub>2</sub> emissions for all treatments (Figure 1). In LF with just the addition of *E. coli* a reduction of NH<sub>3</sub> cumulative emissions of ca. 50% was observed compared to the acidified treatment (*E. coli* + acid). Fangueiro et al. (2015) concluded that decreasing the slurry pH by acid addition is a solution to minimise NH<sub>3</sub> emissions. Although the treatment with acidification showed a marked decrease of CH<sub>4</sub> emissions, the treatments with added biochar showed a marked increase of emissions (109%). In contrast, the treatments with no acidification showed the greatest contribution to the reduction of N<sub>2</sub>O emissions, including the LF with added *E. coli* (-47%). A similar effect has been reported in previous studies, where the addition of biochar resulted in a reduction in N<sub>2</sub>O emissions and the inhibition of the microbial activity at low pH values reduced the CH<sub>4</sub> emissions (Fangueiro et al., 2015; Brennan et al., 2015). To the best of our knowledge, no study has reported the impact of *E. coli* on GHG and NH<sub>3</sub> emissions from slurry.

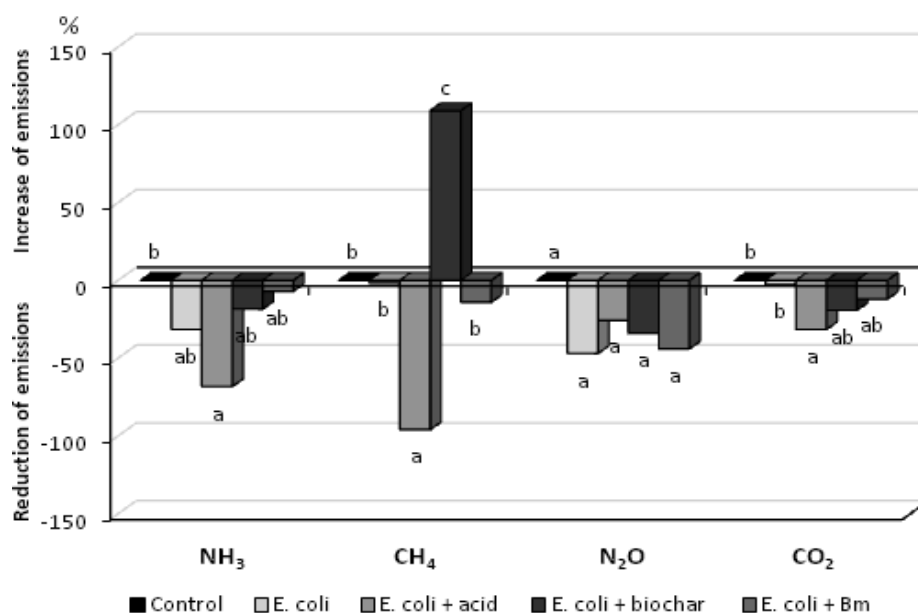

Figure 1. Effect on NH<sub>3</sub> and GHG emissions resulting from the single addition to cattle slurry liquid fraction of *E. coli* or its addition in combination with biochar, sulphuric acid and Bm, in comparison to the control (not treated). Bars with different letters are significantly different from each other at  $p < 0.05$ , using the Tukey HSD mean separation test.

## CONCLUSION

Addition of *E. coli* to LF contributed to the reduction of cumulative emissions of NH<sub>3</sub> and N<sub>2</sub>O. The combination of sulphuric acid and *E. coli* enhanced even more the effect in reducing NH<sub>3</sub> and GHG emissions, namely CH<sub>4</sub> and CO<sub>2</sub>. In contrast, the addition of biochar to cattle slurry LF contributed to increased CH<sub>4</sub> emissions.

**Acknowledgements:** This research was financed by Project I&D INTERACT (Integrative Research in Environment, Agro-Chain and Technology), NORTE-01-0145-FEDER-000017, co-financed by the ERDF through NORTE 2020 (Regional Operational Programme North 2014-2020) and supported by FEDER/COMPETE/POCI, under Project POCI-01-0145-FEDER-006958 and FCT, under the project UID/AGR/04033/2013.

## REFERENCES

- Brennan R.B., Healy M.G., Fenton O., Lanigan G.J., 2015. The effect of chemical amendments used for phosphorus abatement on greenhouse gas and ammonia emissions from dairy cattle slurry: synergies and pollution swapping. *PLoS ONE*, 10(6), e0111965.
- Biswas S., Pandey P.K., Farver T.B., 2016. Assessing the impacts of temperature and storage on *Escherichia coli*, *Salmonella*, and *L. monocytogenes* decay in dairy manure. *Bioprocess Biosyst Eng.*, 39(6), 901-13.
- Fangueiro D., Coutinho J., Chadwick D., Moreira N., Trindade H., 2008. Effect of cattle slurry separation on greenhouse gas and ammonia emissions during storage. *J. Environ. Qual.*, 37(6), 2322-31.
- Fangueiro D., Pereira J., Bichana A., Surgy S., Cabral F., Coutinho J., 2015. Effects of cattle-slurry treatment by acidification and separation on nitrogen dynamics and global warming potential after surface application to an acidic soil. *J. Environ. Manage.*, 162, 1-8.
- Houba V.J.G., Van der Lee J.J., Novozamsky I., 1995. *Soil Analysis Procedures e Other Procedures, Part 5B*, Sixth ed. Wageningen Agricultural University, The Netherlands.

## CHANGES OF PHOSPHORUS AVAILABILITY IN SOILS UNDER DIFFERENT NITROGEN FERTILIZATION LEVELS IN A LONG-TERM FIELD EXPERIMENT

ČERMÁK, P., MÜHLBACHOVÁ, G., KÁŠ, M., MARKOVÁ, K., PECHOVÁ, M.

Crop Research Institute, Drnovská 507/73, Prague 6 – Ruzyně, CZ-161 06, Czech Republic

### INTRODUCTION

Field experiments represent the important tool for studying the long-term effectivity of different management systems in agriculture and they contribute to better understanding of nutrient processes and interactions in soils. The mineral and organic fertilization improves the nutrient availability in soils and subsequently also the crop yields and their quality. Long-term fertilization with simultaneous use of mineral and organic fertilizers can affect the crop yields more than only mineral fertilization (Lin et al. 2015).

Nitrogen and phosphorus are the most important nutrients in soils affecting significantly crop yields. Higher inputs of nitrogen increase crop yields. However, the nutrient uptake by crops can cause the disbalance among nutrients in soils if they are not sufficiently saturated with their adequate amounts.

### MATERIAL AND METHODS

#### Field trial

The permanent organic nitrogen long-term field experiment with organic, mineral and combined organic and mineral fertilization was founded in the year 1984 in Lukavec u Pacova (region Vysočina; altitude 620 m., cambisol, loamy-sandy soil, average precipitations and temperature – 633 mm; 8.7° C, pH (CaCl<sub>2</sub>) 6.2, available nutrients according to Mehlich 3: 126 mg P/kg, K 217 mg K/kg, 125 mg Mg/kg, 1624 mg Ca/kg) with the following crop rotation: potatoes – winter wheat and spring barley. The experiment was divided into three basic blocks: 1) mineral fertilization; 2) fertilization with farmyard manure and combinations with mineral fertilization; 3) straw and combinations with mineral fertilization. The farmyard manure (FYM) was added in dose of 30 t/ha each third year to potatoes, the straw remained in the relevant plots after cereals harvest. Each of basic combinations was fertilized with 0 - 40 - 80 -120 - 160 kg N/ha and with exception of 0 N treatments also with 35 P kg/ha and 83 K kg/ha (PK treatments). Annual dose of nutrients applied as FYM was 43 kg N/ha and 17 kg P/ha. Each treatment had three replications. Treatments with mineral and organic fertilization were concentrated in blocs shifted for every replication in order to change its vertical and horizontal position.

#### Harvest and analytical procedures

The plant and soil samples were taken immediately before harvest the 6<sup>th</sup> August 2016. 2 m of the wheat row were taken from opposite parts of each plot. The straw and grain were weighed separately. The total bioavailable phosphorus content in soils was determined by Mehlich 3 extract (Mehlich, 1984). The phosphorus content in plants was determined by digestion in concentrated HNO<sub>3</sub>, 30% H<sub>2</sub>O<sub>2</sub> by use of microwave Milestone 1200 (Connecticut, USA). All soil and plant extracts were analysed by ICP-OES Thermo Jarrel Ash (Nebraska, USA).

### RESULTS AND DISCUSSION

Winter wheat yield: The medium winter wheat yields according to ANOVA test increased significantly ( $p \leq 0.001$ ) as shows Table 1. The yields of the wheat grain and straw corresponded well to nitrogen supply and the highest yields were generally obtained under the highest dose 160 kg N ha<sup>-1</sup>. It was possible to observe such a diluting effect in P concentrations in wheat grain in treatments with only mineral fertilizers whereas the FYM increased the P concentrations in plant tissues. The treatment with straw did not show such clear results, but as showed also the results, the P input was lower in the straw than in FYM.

P-content in the soil: The P content in soils increased after P fertilization with mineral and particularly with FYM containing also considerable amount of phosphorus. However, increasing nitrogen doses caused a decrease in P

contents in soils available for plants. Particularly, the FYM treatments caused the highest increase of P contents but also more rapid decrease at highest N treatments. Bhattacharyya et al. 2015 considered the interactions between N and P in soils to be the single most important nutrient interaction. In fact, the comparison between P-input in fertilizers and P-uptake by plants showed that with exception of control soils and mineral treatment with 160 kg N ha<sup>-1</sup>, no negative balance was observed. However, the observed decrease of P content in soils following the N fertilization showed that adequate nitrogen fertilization of soils is indispensable for maintaining the right phosphorus supply in agricultural soils.

Table 1. Winter wheat yields, phosphorus content and uptake in long-term field experiment

	Treatment	yield-grain	P content	P uptake	yield-straw	P content	P uptake	P uptake - total
		t ha <sup>-1</sup>	mg kg <sup>-1</sup>	kg ha <sup>-1</sup>	t ha <sup>-1</sup>	mg kg <sup>-1</sup>	kg ha <sup>-1</sup>	kg ha <sup>-1</sup>
Mineral	0	2.84a	3793ef	10.8ab	3.74a	978cd	3.66ab	14.4ab
	PK	2.29a	3693e	8.5a	3.33a	1048cd	3.49a	12.0a
	N 40 PK	4.63b	3459c	16.0d	5.41c	825ab	4.46c	20.5c
	N 80 PK	6.67d	3226a	21.5e	7.26e	750a	5.45d	26.9d
	N 120 PK	7.55e	3434c	25.9e	8.04e	853b	6.86e	32.8e
	N 160 PK	8.64f	3494cd	30.2f	8.94f	883c	7.89f	38.1fg
FYM	0	4.04b	3388b	13.7c	4.77b	978cd	4.66c	18.3b
	PK	4.41b	3370b	14.8c	5.37c	875b	4.70c	19.5bc
	N 40 PK	5.70c	3365b	19.2de	6.33d	817ab	5.17cd	24.3d
	N 80 PK	7.35e	3420c	25.1e	7.86e	884c	6.95e	32.1e
	N 120 PK	8.10f	3479cd	28.2f	8.53ef	1143d	9.75h	37.9fg
	N 160 PK	8.81fg	3646c	32.1f	9.18f	968cd	8.89g	41.0g
Straw	0	4.11b	3370ab	13.9c	5.16c	894c	4.61c	18.5b
	PK	3.90b	3597d	14.0c	4.78b	814ab	3.89ab	17.9b
	N 40 PK	6.18cd	3445c	21.3e	6.85d	745a	5.10cd	26.4d
	N 80 PK	7.55e	3513d	26.5e	8.04e	805ab	6.47de	33.0e
	N 120 PK	8.12f	3393b	27.6ef	8.70f	903c	7.86f	35.4ef
	N 160 PK	7.92ef	3473cd	27.5ef	8.39ef	905c	7.59f	35.1ef

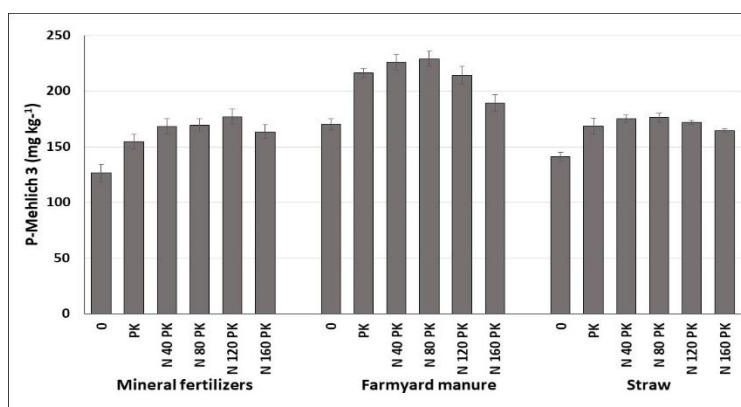

Figure 1. Phosphorus content in soils from long-term field experiment with mineral and organic fertilization

**Acknowledgement:** The research was carried out with support of NAZV ČR no: QJ1530171

#### REFERENCES:

- Bhattacharyya P., Nayak A.K., Shahid M., Tripathi R., Mohanty S., Kumar A., Raja R., Panda B.B., Lal B, Gautam P., Swain C.K., Roy K. S., Dash P.K. (2015): The Crop Journal, 3: 387-395
- Lin Z., Chang X., Wang D., Zhao G., Zhao B (2015): Field Crops Research, 174: 55-60
- Mehlich A. (1984): Communications in Soil Science and Plant Analysis, 15: 1409-1416.

## CHANGES OF SULPHUR AVAILABILITY IN SOILS UNDER DIFFERENT NITROGEN FERTILIZATION LEVELS IN A LONG-TERM FIELD EXPERIMENT

MÜHLBACHOVÁ, G., ČERMÁK, P., KÁŠ, M., MARKOVÁ, K., PECHOVÁ, M.

Crop Research Institute, Drnovská 507/73, Prague 6 – Ruzyně, CZ-161 06, Czech Republic

### INTRODUCTION

Sulphur represents one of the most important nutrients necessary for plants. The deficiency of sulphur has been observed in agricultural soils for several decades and is related to environmental legislations in the Czech republic limiting sulphur pollution by power plants. Consequently, sulphur has become the most limiting element before nitrogen for yields (Matula, 2007). Significant amounts of sulfur in the soil is contained in the soil organic matter, which can be available for plants upon mineralization (Eriksen et al., 1998). Sulphur is absorbed by plants usually as  $\text{SO}_4^{2-}$  anion. The  $\text{SO}_4^{2-}$  anion is highly mobile in the soil solution, because it is repelled from soil particles exposing negative charges and therefore they can be easily leached into lower layers of the soils.

The aim of the research was to evaluate the uptake of sulphur by winter wheat and the soil sulphur stocks under increasing nitrogen doses in a long –term field experiment.

### MATERIAL AND METHODS

#### Field trial

The field trial is described by Mühlbachová et al. (2018). Briefly, a long-term field experiment with organic, mineral and organo-mineral fertilization began in 1984 on Cambisol soil in highlands at Lukavec u Pacova. The crop rotation was potatoes – winter wheat and spring barley. The mineral fertilization, farmyard manure (FYM - 30 t/ha) and straw (remaining postharvest residues) represented three basic combinations of fertilization. The FYM was added each third year to potatoes (annually 43 kg N ha<sup>-1</sup> and 17 kg P ha<sup>-1</sup>). Each of basic combinations was fertilized with 0 - 40 - 80 -120 - 160 kg N/ha and with exception of 0 N treatments also with 35 P kg/ha and 83 K kg/ha (PK treatments). No systematic treatment with sulphur was carried out. Each treatment had three replications.

#### Harvest and analytical procedures

The winter wheat (2 m rows from opposite sides of each plot) and soil samples were taken immediately before harvest the 6<sup>th</sup> August 2016. The total bioavailable sulphur content in soils was determined by Mehlich 3 method (Mehlich, 1984). The plants were digested in concentrated  $\text{HNO}_3$ , 30%  $\text{H}_2\text{O}_2$  using the microwave Milestone 1200 (Connecticut, USA) and the soil and plant extracts were determined by ICP-OES Thermo Jarrel Ash (Nebraska, USA).

### RESULTS AND DISCUSSION

The average of wheat yields increased significantly ( $p \leq 0.001$ ) according to ANOVA test, as shown in Table 1. The yields of the wheat grain and straw responded to nitrogen supply and the best yields were generally obtained under the maximum dose of 160 kg N ha<sup>-1</sup>. The S concentrations in wheat grain and straw under mineral and organic fertilization tended to increase according to the nitrogen dose. Similarly, the sulphur uptake by grain and straw increased significantly. The maximum sulphur uptake by winter wheat reached 18-19 kg S ha<sup>-1</sup> for higher N doses probably due to synergic effect of higher yields and S concentrations in plants.

Concerning soils, the sulphur content increased according to nitrogen fertilization up to 120 kg ha<sup>-1</sup> for all three fertilization systems (mineral, FYM and straw). The highest nitrogen dose (160 kg N ha<sup>-1</sup>) decreased the sulphur content in soil. This decrease is not possible to explain by simple S uptake by plants as only in straw treatment the decrease of S-uptake was noted at 160 kg N ha<sup>-1</sup>. However, Matula (2007) showed that nitrogen fertilization decreased production of sulphates from the mineralization of organic matter and in soils with higher immobilization tendency, the sulphur immobilization was even higher. The interactions between nitrogen and



sulphur reported also Salvagiotti and Mirales (2008) who described positive interactions between these two nutrients and similarly to Matula (2007) reported higher nitrogen use efficiency under sulphur fertilization. The soils our field experiment were not systematically fertilized with sulphur and it could be one of reasons for the decrease of the sulphur content in soils under the highest N rate (Fig. 1).

Table1. Winter wheat yields, sulphur content and uptake in long-term field experiment

	Treatment	yield-grain t ha <sup>-1</sup>	S content mg kg <sup>-1</sup>	S uptake kg ha <sup>-1</sup>	yield-straw t ha <sup>-1</sup>	S content mg kg <sup>-1</sup>	S uptake kg ha <sup>-1</sup>	S uptake total kg ha <sup>-1</sup>
Mineral	0	2.84a	961.4a	2.73a	3.74a	576.9ab	2.16a	4.89a
	PK	2.29a	950.0a	2.18a	3.33a	684.7c	2.28a	4.46a
	N 40 PK	4.63b	958.8a	4.44bc	5.41c	534.3a	2.89b	7.33c
	N 80 PK	6.67d	967.6ab	6.45d	7.26e	626.3bc	4.55d	11.00f
	N 120 PK	7.55e	1153.1c	8.70f	8.04e	984.4e	7.92f	16.62h
	N 160 PK	8.64f	1296.6d	11.20h	8.94f	844.3e	7.55f	18.75i
FYM	0	4.04b	963.1a	3.89b	4.77b	538.9a	2.57ab	6.46b
	PK	4.41b	960.7a	4.23bc	5.37c	520.2a	2.79ab	7.03c
	N 40 PK	5.70c	1008.8b	5.75c	6.33d	556.4ab	3.52c	9.27d
	N 80 PK	7.35e	1053.8c	7.74e	7.86e	712.3d	5.60e	13.34g
	N 120 PK	8.10f	1144.9c	9.27fg	8.53ef	973.8e	8.30g	17.58hi
	N 160 PK	8.81fg	1293.7d	11.40h	9.18f	840.1e	7.71f	19.11i
Straw	0	4.11b	990.1b	4.07b	5.16c	499.7a	2.58ab	6.65b
	PK	3.90b	1005.3b	3.92b	4.78b	509.8a	2.44ab	6.35b
	N 40 PK	6.18cd	1035.7b	6.40d	6.85d	557.8ab	3.82c	10.22e
	N 80 PK	7.55e	1145.3c	8.65f	8.04e	678.5c	5.45e	14.10g
	N 120 PK	8.12f	1191.4c	9.68g	8.70f	975.2e	8.49g	18.16i
	N 160 PK	7.92ef	1275.9d	10.11g	8.39ef	776.2d	6.51ef	16.62h

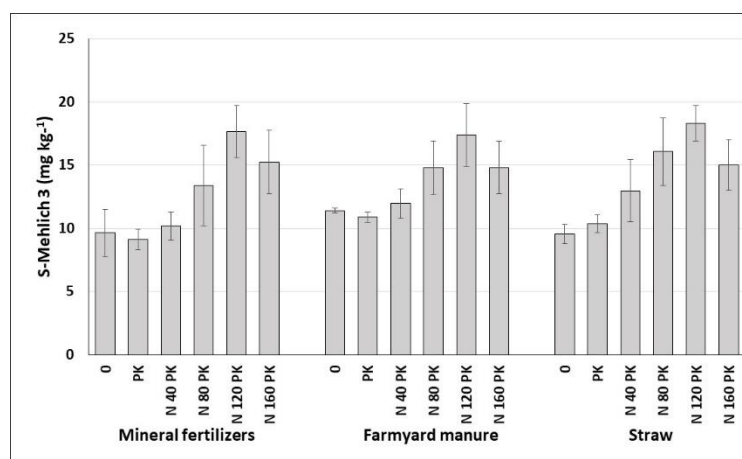

Figure 1. Sulphur content in soils from long-term field experiment with mineral and organic fertilization

**Acknowledgement:** The research was carried out with support of NAZV ČR no: QJ1530171

#### REFERENCES:

- Eriksen J., Murphy M., Schnug E. (1998): Sulphur in ecosystems (ed- E. Schnug). Kluwer Academic Publishers, Dordrecht, Boston, London: 39-73
- Matula J: (2007): Certified methodology, Crop Research Institute, ISBN 978-80-87011-15-7. 39 p.
- Salvagiotti F. and Mirales D. (2008): European Journal of Agronomy, 28: 282-290

## EFFECTS OF SUPPRESSION OF HERBICIDES ON VINEYARD NITROGEN STATUS, AND SOIL MICROBIAL AND CHEMICAL INDICATORS

DUROCHER E.<sup>1</sup>, LANGENFELD, A.<sup>2</sup>, LEY L.<sup>3</sup>, KLEIN C.<sup>1</sup>, THIOUET-SCHOLTUS M.<sup>4</sup>, NASSR, N.<sup>2</sup>

<sup>1</sup> EPLEFPA les Sillons de Haute Alsace, France ; <sup>2</sup> RITTIMO Agroenvironnement, France; <sup>3</sup> INRA SEAV, France ; <sup>4</sup> INRA UR-0055 ASTER, France

### INTRODUCTION

In the North Eastern vineyard, cover cropping is widely used by winegrowers to limit soil erosion and use of herbicides. However, weeds under vine rows are still controlled in a chemical way, in order to reduce the competition with the vine (Wilmes, 2014). A project named “soil management in viticulture” began in 2014 to study the effects of two soil management strategies on agronomical and environmental indices. Mechanical weeding and cover cropping are expected to modify nitrogen dynamics in grapevine soil (Celette et al., 2009).

### MATERIAL AND METHODS

#### Study site and experimental design

The experimental plot is located in Alsace region (France), in the vineyard catchment basin of Hohrain, near Rouffach city. This plot belongs to the “Domaine de l’Ecole”, and was planted in 1998 with Riesling grape variety on a brown calcareous soil. Two different strategies of soil management, covering in an area of 0.15 ha each, were studied. Each strategies is described in Table 1 and were set up in 2014. The first type of soil management, named “classical system” (CS), is the most widespread one in the Alsace region. The second strategy, named “innovative system” (IS), consisted of cover cropping with spontaneous flora one inter-row up to half of the vine-stock and tillage on the second half of the vine-stock and the second inter-row (Table 1). Fungal protection with only organic pesticides was the same for both systems. An organic fertilizer (50 N ha<sup>-1</sup>) was applied at IS in May 2016 and in January 2017 with organic amendment.

#### Measurements

Several measurements were carried out to follow nitrogen levels in soil and in grapevine throughout the year, from 2014 to 2016. Nitrogen status of grapevine was estimated with three indices: Nitrogen Balance Index, calculated from fluorescence measurements of leaves at veraison, wood weight to estimate vine vigour, and yeast available nitrogen in must.

Table 5: Two soil management strategies applied in the experimental plot

	<i>Inter-row 1</i>	<i>Row</i>	<i>Inter-row 2</i>
Classical system (CS)	Cover cropping (spontaneous flora)	Chemical weeding	Tillage
Innovative system (IS)	Cover-cropping (spontaneous flora)	Tillage	

Potential mineralization of nitrogen was measured in soil samples from each system from 2014 to 2016. The microbiological analysis consists in measuring biological and chemical indicators to assess nitrogen dynamics in soil, i.e. nitrogen mineralization (ISO 14238), microbial biomass (16S and 18S qPCR) and activity (Biolog® Ecoplates). Statistical analyses (using Statgraphics) were performed to determine the relationship between biological indicators and nitrogen mineralization regarding soil management strategies.

### RESULTS AND DISCUSSION

On the agronomic point of view, a drop in grapevine's yield was observed in the IS the first year of experimentation (2014), this effect worsened the second year (2015; Fig. 1). This was attributed to a nitrogen stress, confirmed by the Nitrogen Balance Index gap observed in 2014 and 2015. Organic fertilization in the IS allowed maintaining a constant yield in 2016. In 2017, the difference between the two systems was not observed due to a drop of yield in the CS. The gap between the two systems was visible in the first year of the experimentation on other **nitrogen status indices**. Pruning wood weights and especially yeast available nitrogen are affected by the presence of cover crop in the IS. However, the impact on the components of the yield, which are built on two years, was most accentuated in 2015. Interestingly, fertilization applied in May 2016 in the IS allowed to recover nitrogen status indices close to the CS (Fig. 1) in 2016, but was not beneficial for the yield.

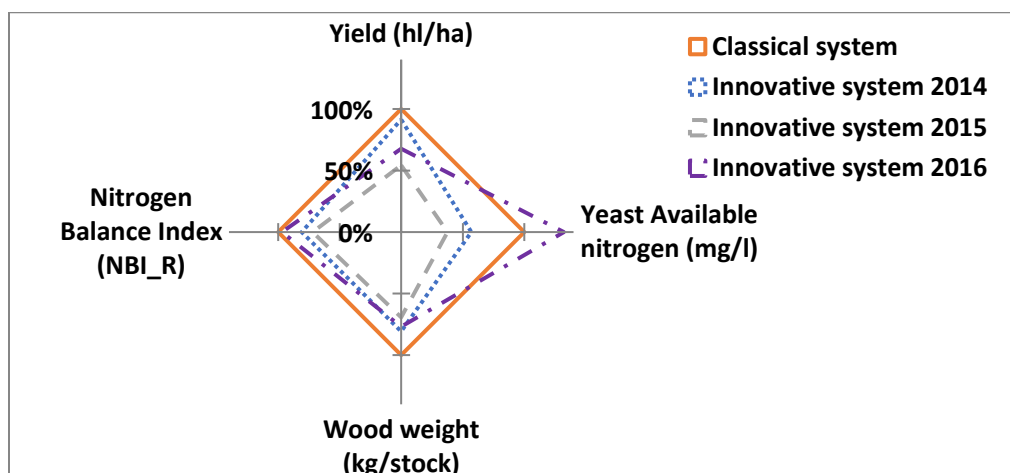

Figure 7: Yield and nitrogen status indices of grapevine of innovative system, as a percentage of classical system from 2014 to 2016.

Samples taken at bud break in 2016 showed an **increase of microbial activity and abundance**, but this effect was not significant. A seasonal effect was observed on the microbial parameter, which could cover the effect of practices. Taken independently, the chemical and microbial parameters did not show any evident effect of management practices on the results obtained. However, when these parameters were combined in a multivariate analysis, classical and innovative systems tend to separate.

## CONCLUSION

Transition towards non chemical weed control method induced significant reduction of yield of grapevines and nitrogen status indices, but can be contained by organic fertilisation. However, we could not differentiate effects of chemical or mechanical weeding on microbiological parameters under the row at 30-cm soil depth. Further analyses are needed to detect potential effects on microbial communities, which can impact biogeochemical cycling of nitrogen in the soil (Steenwerth and Belina, 2008). This project will be pursued in the next years to explore long-term effects of the change of soil management strategy.

**Acknowledgements:** This project was funded by Agence de l'Eau Rhin-Meuse and Comité Interprofessionnel des Vins d'Alsace. We thank the Domaine de l'Ecole for provision of the experimental plot and the experimental unit SEAV (INRA) for participation in the monitoring of the experiment.

## REFERENCES

- Celette F., Findeling A., Gary C., 2009. Competition for nitrogen in an unfertilized intercropping system: The case of an association of grapevine and grass cover in a Mediterranean climate. *European Journal of Agronomy*, 30, 41-51.
- Steenwerth K., Belina K.M., 2008. Cover crops and cultivation: Impacts on soil N dynamics and microbiological

function in a Mediterranean vineyard agroecosystem. *Applied Soil Ecology*, 40, 370-380.

Wilmes C., 2014. Un désherbage mécanique sur vigne qui progresse au delà des producteurs bio. Agreste. Consultable : <http://agreste.agriculture.gouv.fr/IMG/pdf/R4214A15.pdf> [Consulté le 19 juillet 2017].

## LEGUME NUTRIENTS MANAGEMENT FOR SUSTAINING CROP PRODUCTIVITY AND SOIL BIODIVERSITY

TOLEIKIENĖ, M., ARLAUSKIENĖ, A., KADŽIULIENĖ, Ž., SUPRONIENĖ, S.

Lithuanian Research Centre for Agriculture and Forestry, Lithuania

### INTRODUCTION

The production of organic plant-based fertilizers from local resources contribute to sustainability. The management of plant derived fertilizers not only compensates plant nutrient demand, but also increases the soil functioning. Organic fertilizers could be used to balance basic nutrients and C-N-P-K ratio. Selecting appropriate plant species can control nitrogen depletion and prevent nutrients losses or excess. Plant-based fertilizers are often produced from legumes, which contain average N, P content and comparable small K content. Innovative practices involves mixing of plants with different chemical composition, green manure composting and ensiling. Resulting organic matter determines a wider C:N ratio, which limits mineralization and induces humification processes after insertion of green manure into soil. This demonstrates high potential to maintain the close nutrient cycles in organic plant-based farm. This farming method is based on living agro-ecological systems and cycles, where biodiversity plays an important role. However, researchers argue efficiency of organic farming and different management regimes are questioned. One of the main questions in recent literature and this research is - 'could plant-based organic farming significantly increase biodiversity and maintain sufficient crop productivity?'

### MATERIAL AND METHODS

This study aims to differently prepare green manures, used as fertilizers in organic farming. Organic fertilizers were produced in 2015 summer and inserted in 2016 spring, excluding second treatment. Six fertilization treatments were chosen: first- control with no fertilizers (C); second - green clovers mass cut and ploughed in the fall of 2015 (RC); third - red clover ground mass (N50) fermented under anaerobic conditions (FerRC); fourth - fermented pea and spring wheat mass (N25) manure (FerP+W); fifth – composted red clover and straw (N50) manure (ComRC+S), sixth - granulated cattle (N50) manure (GCM) for comparison.

Field experiments were conducted in 2015 - 2017 cropping system. Trial was carried at the Lithuanian Centre for Agriculture and Forestry, in two locations of Lithuania: Dotnuva and Joniškėlis. Site was managed organically. Crop rotation: 2015 - winter wheat, 2016 - spring wheat with organic manure, 2017 - spring barley with clovers. Mineralization, crops productivity, soil chemical composition, biological activity were investigated during experiment. The variation in the concentration of carbon (C), nitrogen (N), phosphorus (P) and potassium (K) in soil are determined by the Diameter method, Kjeldahl method, final photometric determination and atomic absorption method. Mineralisation was assessed by litter-bag method. Microorganisms, earthworms and insects were observed as indicators of biodiversity content. Ecological groups, species, quantity, quality, activity were identified three times in agricultural vegetation. Colony-forming units (CFUs) in appropriate dilutions of the samples with soil bacteria were determined on PCA agar (Oxoid). Microbiological diversity assessed by CLPP - Community Level Physiological Profiling method, using Biolog EcoPlates (BIOLOG Inc, Hayward, CA, USA). Average well-color development (AWCD), richness (R), Shannon diversity index (H), Simpson index (D) were calculated.

### RESULTS AND DISCUSSION

During the Silage and Compost Experiment the influence to organic matter chemical structure and N losses were studied. N content in mulch decreases by 20.4–29.7%. Contrary to organic substances, N content was 26% lower after ensiling compared with the data before ensiling. Larger amount of N was accumulated in RC, ComRC+S and GCM. These fertilizers contained larger amount of P and K, too. Organic fertilizers from exhibiting the lowest

mineralization intensity C:N to highest were as follows: FerP+W < FerRC < GCM < ComRC+S < RC. Highest C:P ratio (1:200-210) was in RC, FerRC and ComRC+S, the lowest C:P (1:76-81) in ComRC+S and GCM.

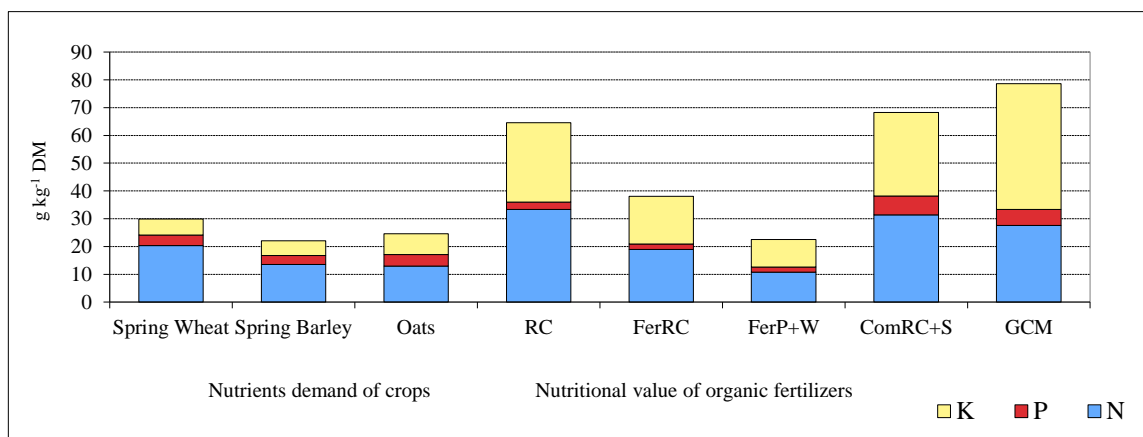

Figure 1. Nutrients N, P, K, demand for spring crops to produce 1000 kg grain yield.

All produced organic manures could maintain at least 1000 kg grain yield productivity, according to chemical composition and nutrients N, P, K ratio (Figure 1). However, not all fertilizers could produce at least 2000 kg grain yield just by itself, without increasing fertilizers rate. In 2016, grain yield of spring wheat increased significantly (28%) using RC inserted in 2015 autumn. Grain yield increased by 17% and 10%, fertilizing in the 2016 spring by GCM and ComRC+S respectively. The grain yield was reduced by the addition of a fermented wheat-peas mixture. In 2017, grain yield increased by 12% in plots fertilized by RC and FerRC, 10% in ComRC+S and GCM.

Ecological environment in fertilised plots was suitable for different organisms activity increase. Not all fertilisers had the same effect on treated biodiversity indexes. Higher earthworms activity was measured whatever the manure process. Most abundant earthworm species were red earthworm (*Lumbricus rubellus* Hofm.) and field worm (*Allolobophora caliginosa* Sav.). Significant increase in earthworm amount were observed using ensiled legume biomass fertilizers. Surprisingly, insects quantity was lowest there GCM was applied, all green manure showed good insects activity. Biggest amount traced there FerP+W was applied. *Carabidae* family was most abundant. All organic manures increased microbial functional diversity in organic farming system. RC and FerRC had higher effect in first vegetation season. FerP+W and ComRC+S - on second year. Best not interrupted effect in both year observed applying GCM. Rates of microbial activity were significantly affected by seasonal conditions and chemical compounds of each manure. Weeds were significantly least abundant in control treatment where no fertilisers were applied.

## CONCLUSION

The highest grain yield was produced using ploughing of fresh red clovers mass in the autumn. The effect was slightly better compared to granulated cattle manure. Despite nutrients conservation while ensiling, it had lower positive effect to grain yield. Nevertheless, we recommend to consider ensilage practise usage for better soil biological activity in organically managed agroecosystems.

**Acknowledgements:** We would like to thank to all technicians in LAMMC that made the best efforts to sample and measure huge amount of data for this work.

## TOWARDS A BETTER UNDERSTANDING OF C AND N CYCLING IN AGRICULTURAL SOILS

SAMSON, M-E.<sup>1,2,3</sup>, CHANTIGNY, M.<sup>2</sup>, ANGERS, D.<sup>2</sup> MENASSERI-AUBRY, S.<sup>3</sup> VANASSE, A.<sup>1</sup>

<sup>1</sup> Laval University, Canada; <sup>2</sup> Agriculture and Agrifood Canada, Canada; <sup>3</sup> Agrocampus-Ouest, Brittany

### INTRODUCTION

Carbon sequestration in agricultural soils could help mitigate climate change, improve soil physical properties and provide nutrients and energy to soil biota through organic matter stabilization (Pautisan et al., 2016). However, in our quest to find strategies to store carbon in agricultural soils, the fact that organic matter decomposition is also a central source of nitrogen for plant growth is generally overlooked. This leads to an important dilemma: is it possible to simultaneously accumulate organic matter and profit from its decay? New theoretical models of the soil organic matter cycle have identified nitrogen as a major player in carbon sequestration (Knicker, 2011). Bimüller et al. (2014) have also suggested a decoupling of carbon and nitrogen cycles in different soil organic matter fractions. Coarse-sized organo-mineral complexes were identified as a fraction that could play an important role in nitrogen mineralization while it presents a relatively low rate of carbon mineralization (Bimüller et al., 2014; Whalen et al., 2000). Agricultural practices such as organic fertilization could promote accumulation of organic matter in this specific fraction (Maillard et al., 2015) and contribute to the release of nitrogen in soil without impacting carbon stocks. The impact of tillage, fertilization and crop residues management on carbon and nitrogen cycle is often studied separately. The objective of this project is to deepen our understanding of the mechanisms involved in carbon storage and nitrogen mineralization soil services considering multiple agricultural practices and their interactions.

### MATERIAL AND METHODS

#### Experiment

This project capitalizes on a factorial experimental platform set up in 2009 at Laval University experimental farm (Québec, Canada) under a wheat-maize-soybean rotation. On two contrasted soil types (silty clay vs sandy loam) are compared: 1) soil tillage regimes (moldboard plow [MB] vs minimum till [MT]), 2) nitrogen sources (complete mineral fertilizer [NPK], liquid swine manure [LSM], liquid dairy cattle manure [LDM], solid poultry manure [SPM] and a mineral fertilizer without nitrogen [PK]) and 3) residue management (returned to the soil [RR] vs harvested [RH]). Crop yield and surface (0-8 cm) soil quality parameters (bulk density, humidity, aggregate stability, microbial biomass carbon and nitrogen, particulate organic matter, etc.) were evaluated annually from 2009 to 2017. Every three years, total nitrogen and carbon were measured in four soil layers (0-15, 15-30, 30-45 and 45-60 cm) to estimate soil carbon and nitrogen stocks. In 2017, soil samples were submitted to a particle size and density fractionation (Maillard et al., 2015) and total nitrogen and carbon content of each organic matter fraction was analyzed. An incubation experiment will soon be performed to compare carbon and nitrogen mineralization dynamics in the bulk soil and in the soil fractions. Ultimately, the data will be used to evaluate strengths and weaknesses of the STICS model for simulating C and N fluxes. Statistical analysis was performed with the mixed procedure of SAS (SAS Institute Inc., Cary, NC, USA). A combined factorial ANOVA model was used with repeated measures to consider the interactions between soil type and treatments as well as the evolution over time. Variance-covariance matrix was chosen to minimize the Akaike criterion and the Kenward-Roger method was used to calculate the degrees of freedom. The results of these statistical tests are reported for a significance level of 0.05.

#### Statistical analysis

Statistical analysis was performed with the mixed procedure of SAS (SAS Institute Inc., Cary, NC, USA). A combined factorial ANOVA model was used with repeated measures to consider the interactions between soil type and treatments as well as the evolution over time. Variance-covariance matrix was chosen to minimize the Akaike

criterion and the Kenward-Roger method was used to calculate the degrees of freedom. The results of these statistical tests are reported for a significance level of 0.05.

## RESULTS AND DISCUSSION

After eight years of treatments, we observed an important interaction between soil tillage regime and residue management on multiple soil quality parameters. Aggregate mean weight diameter, particulate organic matter and microbial biomass were all significantly greater under MT than MB when crop residues were returned to the soil. In the MB treatments, these parameters had lower values and the effect of residue management was less important. Nitrogen sources had no effect on total carbon in the surface soil layer, but organic fertilizers resulted in greater microbial biomass C and N than mineral fertilizers, and the microbial biomass was also smaller with NPK than PK. Moreover, the microbial biomass C to microbial biomass N ratio was narrower in the treatments with organic amendments compared to NPK and PK treatments suggesting accumulation of relatively labile organic matter in soil amended with organic fertilizers. These results are in line with those of Maillard et al. (2015) who found enrichment with low carbon/nitrogen ratio organic matter in coarse-sized organo-mineral complexes following a recurrent application of liquid swine manure.

## CONCLUSION

Preliminary results from our experiment suggest that the nitrogen source has an important effect on soil organic matter quality. They also highlight the impact of interactions among agricultural practices on soil carbon and nitrogen cycling. The soil fractionation data and soil carbon and nitrogen stocks will be analyzed soon and should help better understand carbon and nitrogen storage and remineralization dynamics in functionally different soil organic matter fractions as influenced by tillage, nitrogen source and crop residue management. Ultimately, these results will be compared to the ones simulated by the STICS model to validate the consideration of interactions among agricultural practices and carbon and nitrogen coupling when modeling carbon and nitrogen fluxes in agrosystems.

## REFERENCES

- Bimüller, C., Mueller, C.W., von Lützow, Kreyling, O., Kölbl, A., Haug, S., Schloter, M. et Kögel-Knaber, I. 2014. Decoupled carbon and nitrogen mineralization in soil particle size fractions of a forest topsoil. *Soil Biol. Biochem.* 78: 263-273.
- Knicker, H. 2011. Soil organic N – An under-rated player for C sequestration in soils? *Soil Biol. and Biochem.* 43: 1118-1129.
- Maillard, E., Angers, D.A., Chantigny, M., Bittman, S., Rochette, P., Lévesque, G., Hunt, D., Parent, L.E. 2015. Carbon accumulates in organo-mineral complexes after long-term liquid dairy manure application. *Agric. ecosyst. environ.* 202: 108-119.
- Paustian, K., Lehmann, J., Ogle, S., Reay, D., Robertson, G.P., et Smith, P. 2016. Climate-smart soils. *Nat.* 532: 49-57.
- Whalen, J.K., Bottomley, P.J. et Myrold, D.D. 2000. Carbon and nitrogen mineralization from light and heavy fraction addition to soil. *Soil Biol. Biochem.* 32: 1345-1352.



## UREA DEEP PLACEMENT FOR TRANSPLANTED RICE: COMPLEMENTARITY OF <sup>15</sup>N-LABELLING AND AMMONIACAL N DIFFUSION STUDIES TO UNDESTAND THE FERTILIZER-N EFFICIENCY

GAUDIN, R.<sup>1</sup>, D'ONOFRIO, G.<sup>2</sup>

<sup>1</sup> UMR System, France; <sup>2</sup> retired, Italy

### INTRODUCTION

Urea deep placement is considered as one of the best way to avoid N losses in paddy soils. The urea N and the ammoniacal N deriving very quickly from it are weakly affected by the classical mechanisms of runoff, ammonia volatilization and nitrification-denitrification because of the low diffusion of ammonium from the anaerobic layer of the soil to the aerobic layer. The levels of ammoniacal N attained at the site of placement are in relation with the mass of urea supergranule (USG) used (Gaudin and Dupuy, 1999). If this mass is too high, some unbalance in the source-sink relationship can occur (Gaudin and D'Onofrio, 2015). This phenomenon is a hot topic in the context of paddy rice for ensuring the best N recovery from fertilizer-N. To insure a good balance together with an important level of N fertilization essential for high yield, some researchers are now proposing to use a single USG per transplant (two- or three-strand transplantation) at 12 cm depth (Liu et al., 2017; Wu et al., 2017). Here we discuss the results obtained in studies using <sup>15</sup>N labelling of urea or soil solution sampling associated with a model of ammonia diffusion. The <sup>15</sup>N experiment aimed at specifying the kinetics at which the nitrogen passes from the fertilizer to the grain and straw. The following question is investigated: Should the gain of information obtained with the soil solution measurement be sufficient to generalize this approach and use it to study other geometries either of nitrogen application or/and of fertilizer (capsules, etc.)?

### MATERIAL AND METHODS

A field located near the Onibe bridge, 5 km west from Arivonimamo (Madagascar) has been selected for the <sup>15</sup>N experiment and four years later for the soil solution monitoring in the vicinity of the USG. The mass of USG was 2 g. The soil solution sampler was 15 mm long and 13 mm in diameter. The soil solution was drawn from the soil by vacuum application and collected in penicillin bottles. Ammonia and urea were measured by colorimetry: indophenol blue method and diacetylmonoxim-thiosemicarbazide method respectively. The results of the two experiments have been analyzed separately (Dupuy et al., 1990; Gaudin and Dupuy, 1999). Here we are examining the complementarity of the two kinetics, the first one for the labelling experiment, the second one for ammonia disappearance from the soil solution.

### RESULTS AND DISCUSSION

The recovery of nitrogen was high, attaining 60.7% at 73 DAT (days after transplanting). It was 41.8% at 52 DAT and only 9.8% at 32 DAT. As shown on Fig. 1, the disappearance of ammoniacal N from the soil solution followed a first order kinetics between 10 mM and 0.05 mM ammoniacal N. The time at which this disappearance occurs is well adjusted on the kinetics of labelling suggesting that the assimilation of ammoniacal N was rapid and mobilized all the carbon resources (photosynthates) at disposal at this time (Gaudin and D'Onofrio, 2015).

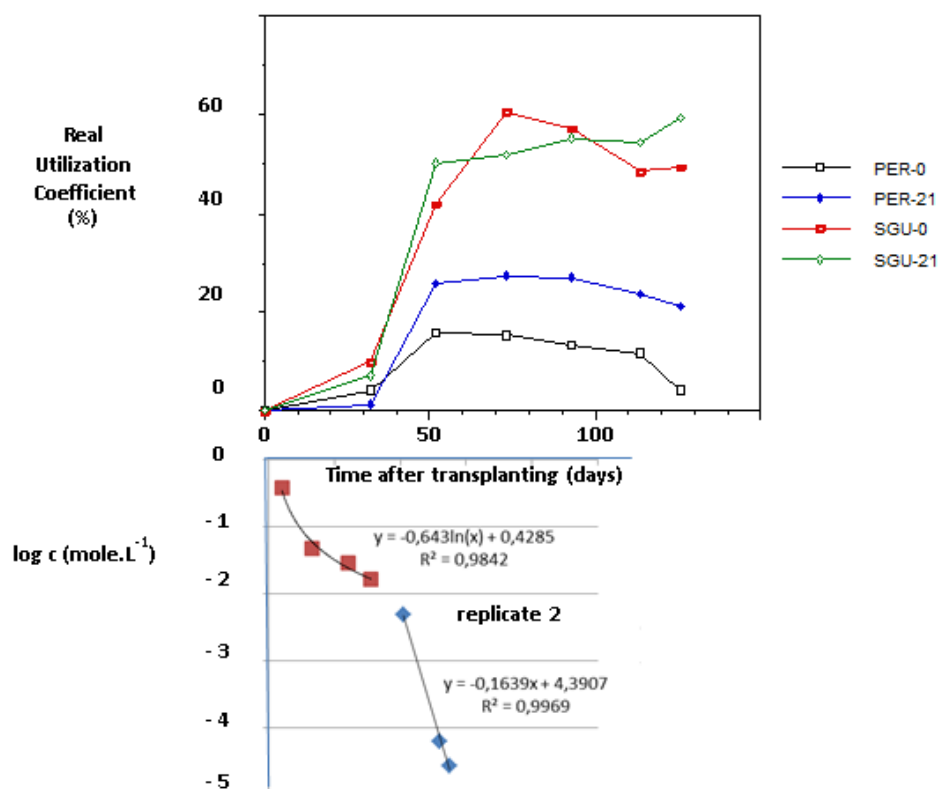

Figure 1. Comparison between the dynamic of the Real Utilization Coefficient obtained by a  $^{15}\text{N}$  labelling experiment and the time course of ammoniacal N concentration in the placement site of one 2 g USG (only one of six replications displayed). PER-0 and PER-21, prilled urea applied at transplanting or 21 days later, SGU-0 and SGU-21, 2 g urea supergranules deep-placed at 10 cm between four transplants at transplanting or 21 days later.

## CONCLUSION

Soil solution sampling is a simple technique to be used in paddy soils. In this context, the monitoring of ammoniacal N after deep placement of fertilizer-N could be used to test multiple possibilities in new geometries of fertilizer application or of the fertilizer-N itself. Deep line application or open capsules are interesting options.

## REFERENCES

- Dupuy J., Gaudin R., D'Onofrio G., 1990. Etude à l'aide d'urée enrichie en  $^{15}\text{N}$  de la fertilisation azotée du riz inondé à Madagascar. III- Cinétique de prélèvement de l'azote apporté sous forme de supergranules d'urée ou de perlurée au repiquage du riz inondé ou 21 jours après. *Agro. Trop.* 45, 21-30.
- Gaudin R., Dupuy J., 1999. Ammoniacal nutrition of transplanted rice fertilized with large urea granules. *Agron. J.* 91, 33-36.
- Gaudin R., D'Onofrio J., 2015. Is the source-sink relationship in transplanted rice receiving deep-placed urea supergranules in transplanted rice dependent upon the geometry of transplanting? *Paddy Water Environ.* 13,433-442.
- Liu X., Wang H., Zhou J., Chen Z., Lu D., Zhu D., Deng P., 2017. Effect of nitrogen root zone fertilization on rice yield, uptake and utilization of macronutrient in lower reaches of Yangtze River, China. *Paddy Water Environ.* 15, 625-638.
- Wu M., Li G., Li W., Liu J., Liu M., Jiang C., Li Z., 2017. Nitrogen fertilizer deep placement for increased grain yield and nitrogen recovery efficiency in rice grown in subtropical China. *Front. Plant Sci.* 8,1227.

## A COMPREHENSIVE ANALYSIS OF N-LOSSES FROM URINE PATCHES IN DAIRY PASTURE SYSTEMS

CAROZZI, M.<sup>1</sup>, BRETSCHER D.<sup>1</sup>, VOGLMEIER K.<sup>1</sup>, AMMANN, C.<sup>1</sup>

<sup>1</sup> Agroscope, Climate and Agriculture Group, Zurich, Switzerland

### INTRODUCTION

Urination by grazing animals causes a mosaic of isolated patch characterised by high N concentration. In the case of dairy cow, 200 to 2000 kg N ha<sup>-1</sup> can be supplied over small soil surfaces ranging from 0.15 to 0.5 m<sup>2</sup>, and which can affect soil processes up to double of their surface (Selbie et al., 2014). These loads largely exceed plant uptake capacity causing significant N losses through NO<sub>3</sub> leaching, gaseous emissions including N<sub>2</sub>O, NO<sub>x</sub> and NH<sub>3</sub>, and water runoff. Process-based models revealed suitable tools to interpret and analyse the biogeochemical processes occurring in the soil, plant, animal and the releases of reactive N forms towards the environment. Conversely, the large amount of interacting process involved in the N-cycle means that the dataset required to comprehensively validate these models would be prohibitively large.

The majority of pasture models simulating animal excreta as a uniform broad application at paddock scale, without considering the local effects introduced by these point sources (Giltrap et al., 2015). This simplification does not consider the transformations and the losses occurring within these temporary hotspots for N, often misinterpreting the processes themselves, especially for by-products such as N<sub>2</sub>O with large greenhouse potentials. In other hands, considering and simulating all the spatial heterogeneity within a paddock would come with remarkable computing expenses affected by some degree of redundancy and upscaling issues. The aim of this work is to assess via simulation modelling the transformation and the fate of the N applied from urine patches in dairy pasture systems based-model, to address current gaps in the discretisation of N releases. Fertilisation input as NH<sub>4</sub>, plant uptake, gaseous emissions as NH<sub>3</sub> and N<sub>2</sub>O, NO<sub>3</sub> leaching to groundwater, as well as N-fixation were reported in this analysis.

### MATERIAL AND METHODS

The analysis was carried out by using a representative model, PaSim (Riedo et al., 1998). PaSim is a biogeochemical model able to interpret the dynamics and the interactions of grasslands and breed herbivorous at paddock scale. The model consists of sub-models for vegetation, grazing animals, microclimate, soil biology, soil physics and management. It requires easy-to-obtain input parameters and can simulate a series of management practices (e.g. cutting, fertilisation, number and characteristics of grazers) at daily time step. This model has been applied at the scale of urine-patch assessing the effect of a single urine application over a year.

The application time coinciding with the first grazing event of March referring to a typical rotational system in Switzerland (Posieux, Swiss Plateau). N releases were assessed varying the patch size, from a representative surface of 0.2 m<sup>2</sup>, to a very small surface of 0.05 m<sup>2</sup>, to a surface of 1000 m<sup>2</sup> to be close enough to the paddock scale. Urine was simulated as a distribution of ammoniacal N to the soil surface at a rate of 20 g N patch<sup>-1</sup>, together with an additional 2 litres rain, while cow grazing actions were mimicked with cuts. During the simulated year, management events as mowing and fertiliser applications were also reproduced, although the effect of trampling on grass was not evaluated.

### RESULTS AND DISCUSSION

Increasing patch size towards the paddock scale (1000 m<sup>2</sup>), N losses reducing exponentially and coinciding with the scenario with no application of urine (Figure 1). NO<sub>3</sub> leaching represents the highest N loss from the system, 40 times higher in the representative patch of 0.2 m<sup>2</sup> with respect to the paddock scale, and over 200 times higher in the 0.05 m<sup>2</sup> patch. This fact is closely related to the amount of water distributed per surface unit per patch. The emission factor of N<sub>2</sub>O, or the ratio between the N<sub>2</sub>O emitted to the total N distributed, was 1.0% at paddock

scale, 4.8% for the smallest patch, and 7.5% for the patch of 0.2 m<sup>2</sup>, in reason to the higher nitrate content in the first soil profile. The ratio between NH<sub>3</sub> volatilised and NH<sub>4</sub>-N applied was greater at large-scale than in the two small patches, due instead to the lower amount of N infiltrated along the profile.

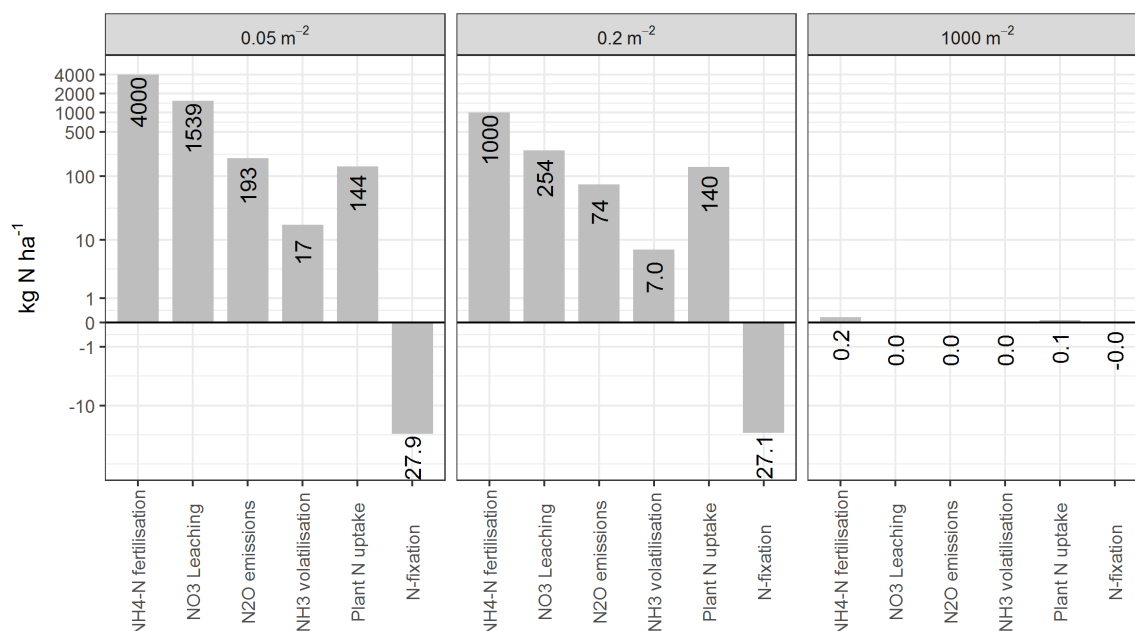

Figure 1. Allocations between the N pools after the application of urine patches for the month of March and over a year. Results are reported in logarithmic scale as the difference with a no-application scenario.

Grass biomass production in both 0.05 and 0.2 m<sup>2</sup> patches had a +10% increase compared to the paddock scale, with a decrease in N-fixation (-25%) and a 30% higher uptake of N. Varying the date of application to warmer and drier periods, greater N-fixation, higher NH<sub>3</sub> and lower NO<sub>3</sub> losses were observed. Finally, the model exhibit a very high capacity to stock NO<sub>3</sub> and NH<sub>4</sub> into the soil profile, standing several months after the distribution, highlighting some issue probably related to the water and NO<sub>3</sub> retention through soil layers.

## CONCLUSION

Urine patches have large impact on N losses in air and groundwater because of the high amount of N supplied to the soil, even if in small area. The allocation of these amounts have to be better discretised in the N-pools of the biogeochemical models, which might give a proper estimate of the losses compared to measures, although frequently produced via wrong processes.

## REFERENCES

- Giltrap DL, Vogeler I, Cichota R, Luo J, van der Weerden TJ, de Klein CAM, 2015. Comparison between APSIM and NZ-DNDC models when describing N-dynamics under urine patches, *New Zealand J. of Agric. Res.*, 58:2, 131-155
- Selbie D., Buckthought L.E., Shepherd M.A. 2015. The Challenge of the Urine Patch for Managing Nitrogen in Grazed Pasture Systems. *Advances in Agronomy* 129:229-292.
- Riedo, M., et al. (1998) A Pasture Simulation Model for dry matter production, and fluxes of 786 carbon, nitrogen, water and energy. *Ecological Modelling* 105, 141-183.

## INCREASING NUTRIENT USE EFFICIENCY BY USING CONTROLLED RELEASE FERTILIZERS FITTED TO THE CROP NEEDS

CLEMENS, R.<sup>1</sup>, TERRONES, C.<sup>1</sup>, PARDOSSI, A.<sup>2</sup>, INCROCCI, L.<sup>2</sup>

<sup>1</sup> ICL Specialty Fertilizers, Netherlands; <sup>2</sup> Department of Agriculture, Food and Environment, Pisa University, Italy;

### INTRODUCTION

Sustainable agriculture demands efficient fertilization practices in order to reduce nitrogen (N) losses. N Losses by leaching, volatilization or denitrification can dramatically reduce the efficiency of the applied nitrogen, which is no longer acceptable. For this reason, it is urgent to find solutions which improve the Nitrogen Use Efficiency (NUE) while reducing Nitrogen losses.

Controlled release (coated) fertilizers are relatively new in the agricultural market and offer a predictable and consistent release of nutrients in a specific period of time. Since the amount of N released daily is small and goes in line with plant uptake requirements, this sort of fertilizers could be an interesting tool to reduce nutrient losses and optimize NUE (Diara *et al.*, 2014; Terlingen *et al.*, 2016).

### MATERIAL AND METHODS

Specific leaching studies have been executed in the period 2015-2016 in cooperation with the University of Pisa. In order to overcome the complications caused by the un-controlled rainfall typical on an open-field system, the experiments were conducted in a greenhouse of the University of Pisa. For this purpose, a lysimeter system was used, built using big containers (180 liters volume), filled with sandy soil. The main goal of these trials was to quantify the reduction of N leaching in a tomato crop (F 1 “Optima”) when using N-Coated fertilizer (Agrocote, made using the E-Max technology) as compared to ammonium sulfate traditionally used for base fertilization. The experiment was designed in order to apply 10 g N, 1.2g P and 12 g K for each tomato plant during the whole growing cycle, using different N sources as base fertilization:

- i) Control (grower’s practice) : 2.5g N as Ammonium Sulphate
- ii) E-Max 50% : 5.0 g N as Agrocote Max N
- iii) E-Max 75% : 7.5 g N as Agrocote Max N

The remaining N was applied via fertigation. Besides N leaching, other parameters such as yield and N uptake were measured in this study. In order to calculate NUE indicators, a zero fertilizer treatment was included (data not shown). All the drainage leaked from the lysimeter was collected and analyzed for its N content. Data on fruit quality and quantity were also recorded.

### RESULTS AND DISCUSSION

As seen on Table 1, the use of E-Max coated N significantly reduced the amount of N leached. This was found despite the fact that the E-Max treatments had a higher fraction of the total N added as base fertilizer. This reduction in leaching was even more evident when a higher percentage of the total N was applied as E-Max coated N (E-Max 75%). In respect to yield and N uptake by the fruits, the use of E-Max coated N had a clear positive effect. The highest yields and N uptake rates were obtained when a higher percentage of the total N was supplied as E-Max coated.

Table 1. Nitrogen source influence on different parameters. Different letters identify significant differences ( $P < 0.95$ ), according to Tukey test.

Parameter	Control		E-Max 50%		E-Max 75%	
N leached (kg/Ha)	46	a	28.4	b	20	c
Total Yield (t/Ha)	42.1	b	47	ab	49.5	a
Total N in the fruits (Kg/Ha)	67.3	b	75.5	ab	84.3	a

There was a significant improvement in both NUE indicators considered for this study (Figure 1), where the efficiency rate was positively correlated with the amount of N supplied via E-Max coated N.

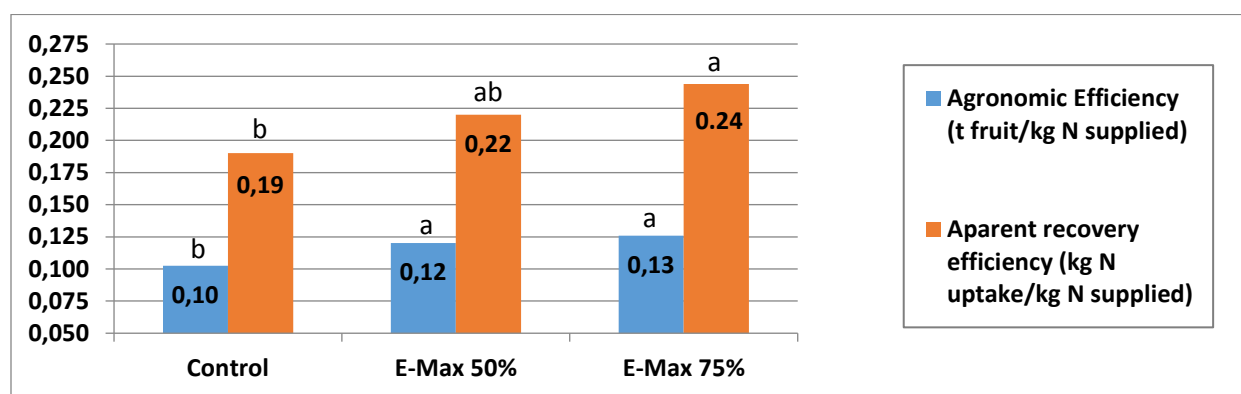

Figure 1. Nitrogen source influence on NUE parameters. Different letters identify significant differences ( $P < 0.95$ ), according to Tukey test.

## CONCLUSION

The use of coated Nitrogen as base fertilizer had a clear effect in reducing nitrogen losses, increasing yields and improving the NUE. The effects were more pronounced when the relative amount of E-Max coated N increased, which proves that this technology is a promising tool to improve fertilization efficiency.

## REFERENCES

- Terlingen, J.G.A., Radersma, S., Out, G.J.J., Hernandez-Martinez, J., Raemakers-Franken, P.C. (2016) Current Developments in Controlled Release Fertilizers. *Proceedings / International Fertiliser Society*: 781 (ISSN 1466-1314)).
- Diara, C., Incrocci, L., Incrocci, G., Carmassi, G., Pardossi, A., Cozzi, P., Fibbi, F., Marzialetti, P. and Clemens, R. (2014). Reduction of Nutrient Run-off by the Use of Coated Slow-Release fertilizers on Two Container-Grown Nursery Crops. *Acta Hortic.* 1034, 85-91.

## POLYSULPHATE - A NEW MULTI NUTRIENT FERTILIZER WITH SULPHUR, POTASSIUM, MAGNESIUM AND CALCIUM - FOR BETTER NITROGEN USE EFFICIENCY

IMAS, P.<sup>1</sup>

<sup>1</sup> Chief Agronomist, ICL Fertilizers, Israel

Polysulphate is a new multi-nutrient fertilizer, available in its natural state, and mined in the UK. It has four nutrients Polysulphate is the trade mark of the mineral 'Polyhalite', which is one of several evaporate minerals containing potassium. Polyhalite (dehydrate) is a single crystal complex with 2 molecules of water of crystallization. It is not a mixture of salts. The chemical formula is  $K_2Ca_2Mg(SO_4)_4 \cdot 2(H_2O)$ . Polysulphate contains sulphur (S, 48%  $SO_3$  as sulphate), potassium (K, 14%  $K_2O$  as sulphate of potassium) magnesium (Mg, 6%  $MgO$  as magnesium sulphate) and calcium (Ca, 17%  $CaO$  as calcium sulphate). It is a water-soluble material therefore its nutrients are readily available for plant uptake. Polysulphate comes from the polyhalite layer of bedrock, over 1000m below the North Sea off the North Yorkshire coast in the UK.

Being nitrogen (N) free, farmers can separate S and K from N application thus giving full flexibility with the N source and dose. Polysulphate can be applied before planting, while N can be applied after germination at the right time for the crop, in the right form, and in right weather conditions avoiding N overdosing or leaching. Higher N use efficiency can be achieved without waste and unnecessary cost to the farmer or the environment.

It is well understood that a balanced supply of available N and S is essential for the synthesis of true proteins from the precursor amino acids. A lack of S limits the production of two of the amino acids which are required constituents of all proteins – cysteine and methionine. The deposition of S from industry to agricultural (and other) land was historically well in excess of crop and animal requirements. Thus, S was not discussed as a crop nutrient.

However, nowadays the S emissions had declined sharply and the need for S fertilizer is recognized and applied by many growers. The majority of the fertilizer S requirement to date has been met using ammonium sulphate. Containing both N and S, this is a useful product for use on crops which require both nutrients, but not for legumes which, because of their Rhizobial associations, do not normally receive any N fertilizer.

Polysulphate, having a high S content and lacking N but with the additional benefit of three other essential nutrients – K, Mg and Ca – is thus a useful fertilizer for legumes. In a Lucerne trial in Scotland, the N:S ratio in the Polysulphate treatment was improved to the 12:1 target value required for optimal digestibility, while at the same time the crude protein content improved by about 10%.

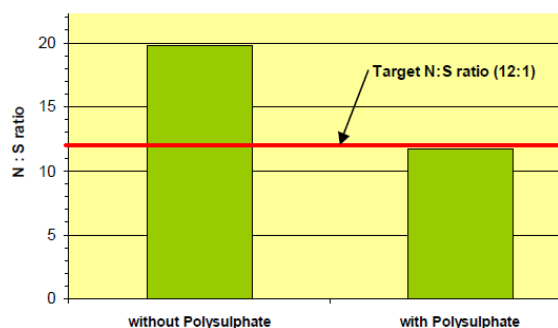

Figure 1. Beneficial effects of an application of 96 kg  $SO_3$ /ha from Polysulphate on the N:S ratio of Lucerne.

In wheat trials in USA, application of Polysulphate resulted in smaller N:S ratios in grains inferring better baking quality for optimum dough and bread making properties. Additionally, an S deficiency or an N surplus may lead to asparagine and glutamine accumulations. During the baking process, free asparagine may promote acrylamide synthesis, a compound considered to be a neurotoxin and potential carcinogen. Thus, Polysulphate not only increases wheat yield but also promotes a more nutritional processed product.

## **CONCLUSION**

Polysulphate is a nitrogen free fertilizer which provides four nutrients in one application, avoiding N overdosing or leaching. An increased nitrogen use efficiency can be achieved along with better quality of grain proteins and improved baking quality. In addition, it delivers comprehensive nutrition for nitrogen-fixing legumes, where no nitrogen fertilization is needed.

## **REFERENCES**

- Barbarick K. 1991. Polyhalite application to sorghum-sudangrass and leaching in soil columns. *Soil Sci.* 151(2):159–166.
- Dugast P. 2015. Use of polyhalite as a source of sulfur for oilseed rape and winter wheat in France. *International Potash Institute (e-ifc)* 43:21-26.
- Tiwari D., Pandey S., Katiyar N. 2015. Effects of polyhalite as a fertilizer on yield and quality of the oilseed crops mustard and sesame. *International Potash Institute (e-ifc)* 42:13–20.
- Vale F. 2016. Calcium and magnesium movement in soil profile with polyhalite as potassium fertilizer for soybean crop. *Proceedings of FERTBIO 2016, Goiana, Brazil, October 16–20, 2016.*
- Yermiyahu U., Zipori I., Faingold I., Yusopov L., Faust N., Bar-Tal A. 2017. Polyhalite as a multi nutrient fertilizer – potassium, magnesium, calcium and sulfate. *Israel Journal of Plant Sciences*, 64: 145-156.



## IMPACT OF ANAEROBIC DIGESTION ON N BALANCE IN A CROP SUCCESSION FERTILIZED WITH TREATED OR UNTREATED MANURES: FIRST RESULTS

SAVOIE A.<sup>1</sup>, PASQUIER C.<sup>2</sup>, AYZAC A.<sup>2</sup>, VOYLOKOV P.<sup>3</sup>, LEMEKHOVA A.<sup>3</sup>, GENERMONT S.<sup>3</sup>, LOUBET B.<sup>3</sup>, HENAULT C.<sup>2</sup>, HOUOT S.<sup>3</sup>

<sup>1</sup> INRA UEPAO, 37380 NOUZILLY, FRANCE; <sup>2</sup> INRA UR SOLS, 45000 ORLEANS, FRANCE; <sup>3</sup> INRA Ecosys, 78850 THIVERVAL-GRIGNON, FRANCE;

### INTRODUCTION

Anaerobic digestion has been encouraged in France since 2013 when the Ministry of Agriculture implemented the EMAA plan (Energie Méthanisation Autonomie Azote). Anaerobic digestion has been quickly developing, mainly on farms with animal breeding. Mesophilic and liquid anaerobic digestion is the most frequent process used on farms, often followed by a post-treatment through separation of liquid from solid phases. Thus, when the farmers used to spread solid farmyard manure and/or liquid slurry in their fertilisation strategies, they now have to use either raw liquid digestate directly coming out of the digester or separated solid and liquid phases when phase separation is present. The MetaMetha project has been started to evaluate the impact of including a digestion step in manure treatment on C and N behaviour when treated or untreated manure were used for crop fertilisation in a field experiment comparing the different fertilisation strategies. The results of the first crop of the field experiment will be presented.

### MATERIAL AND METHODS

The field experiment which will last for 3 years is located in Nouzilly (INRA, Centre-Val de Loire region, France) where anaerobic digestion has been implemented since 2014 (animal manures, sewage sludge, industrial wastes, harvest residues). The anaerobic digestion includes 2 successive reactors of 1600 and 700 m<sup>3</sup> (70 and 28 days of residence time, respectively). After anaerobic digestion, raw digestate is processed to achieve a solid-liquid separation using a separator based on screw press. The crop succession will be wheat in 2017, rapeseed in 2018 and wheat in 2019. The field experiment includes 5 large plots (24 x 75 m: 1800 m<sup>2</sup>) comparing different fertilisation strategies: (A) untreated slurry in March and April (2017/03/22, 2017/04/19) on wheat, then farmyard manure in summer (2017/08/02) after wheat harvest and before rapeseed seedling; (B) mineral N (UAN) in March and April, nothing during summer; (C) liquid phase applied in March and April, then solid phase in summer; (D) control without N application; (E) raw digestate for all applications. The field experiment is presented in Figure 1.

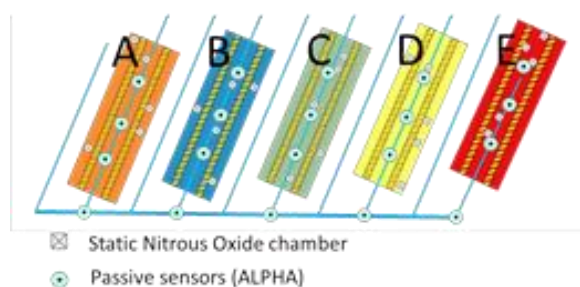

Figure 1: Design of the field experiment: (A) liquid slurry; (B) mineral fertilizer; (C) liquid phase of digestate; (D) control without N; (E) raw digestate. The static chambers used for N<sub>2</sub>O emission and the passive sensors for NH<sub>3</sub> measurements are represented.

The objective was initially to apply similar amount of available N in the different treatments at each application. Ammonia volatilization was assessed immediately after each application using passive sensors (ALPHA) then using the FIDES model (Loubet et al., 2017). The N<sub>2</sub>O emissions were assessed using static chambers and regular

measurement of N<sub>2</sub>O emission. The crop yields and N exported in grains and crop residues were also measured. Finally, mineral N stocks in soils were measured in February before the first application, after crop harvest in summer then before the drainage period in late autumn. All data were then used to compare the N efficiency of the different fertilisation strategies and the environmental impacts through gas emissions in the different treatments. Detailed results of ammonia volatilization are presented in a parallel paper proposed by Voylokov et al.

## RESULTS AND DISCUSSION

The mineral and total N applied in each treatment and corresponding to the two applications are presented in Table 1. The slurry was more diluted than expected and the corresponding N applied was low. On the other hand, total N concentration was higher than expected in the raw digestate leading to high total N applied in this treatment.

*Table 1: Total and mineral N applied in the different treatments. Total N losses through NH<sub>3</sub> and N<sub>2</sub>O emission. Total N exported by crops and corresponding apparent N use (<sup>1</sup> based on rapid hydrolysis of urea).*

Treatment	Total N applied	N-NH <sub>4</sub> applied	N-NH <sub>3</sub> emission		N <sub>2</sub> O emission	Net N <sub>2</sub> O emission	N crop	Apparent N use
	kg N ha <sup>-1</sup>		kg N ha <sup>-1</sup>	% N-NH <sub>4</sub> applied	g ha <sup>-1</sup>	g 100kg <sup>-1</sup> N	kg N ha <sup>-1</sup>	% N applied
A: slurry	100	69	2.2	15.7	95	66	139	46
B: mineral N	129	97 <sup>1</sup>	-3.3	4.8	203	134	165	52
C: liquid digestate	260	136	13.9	16.5	275	95	193	34
D: control	0	0	-8.6	-	30		81	
E: raw digestate	298	150	39.7	32.3	250	74	168	23

All measured fluxes are also presented in Table 1. Ammonia deposit was observed in the control treatment due to animal breeding in the vicinity. In all the fertilized treatment NH<sub>3</sub> emission occurred (net from the control). The lowest was observed with mineral N application (4.8% of mineral N emitted). Ammonia emission was larger with the raw digestate (32% of NH<sub>3</sub> lost) than with liquid phase or slurry (15 to 17% of NH<sub>3</sub> lost). The N<sub>2</sub>O emission was much lower than ammonia emission as classically observed. The emission factors varied between 0.06 and 0.13% of the total N applied. The apparent use of the N applied was similar in the slurry and mineral N treatment. It was lower with the raw digestate than with the liquid phase. The applied doses larger than expected may explained these low apparent N recoveries. However, with similar amounts of NH<sub>4</sub> applied, volatilization was largest with the raw digestate compared to liquid digestate, which may be explained by their different viscosity.

## CONCLUSION

The first results tended to show that phase separation make possible a better valorisation of N by crops with lower ammonia emission. N<sub>2</sub>O emission factors were lower than the 1% classically used in the environmental assessment of crop fertilisation. Similar measurements will be realized after each application of organic and mineral fertilizers during 3 years and will allow to calculate the N balance of all the fertilisation strategies.

**Acknowledgements:** The MétaMéthas program is financed by the Centre-Val de Loire region (convention n° 2016 – 00108447). The authors acknowledged Baptiste Hénault, Céline Decuq, Eric Vachet and Yolaine Delaunay for their help with the analysis.

## REFERENCES

Loubet, B., Carozzi, M., Voylokov, P., Cohan, J.-P., Trochard, R., and Générumont, S.: Evaluation of a new inference method for estimating ammonia volatilisation from multiple agronomic plots, *Biogeosciences Discuss.*, <https://doi.org/10.5194/bg-2017-424>, in review, 2017.

## **NO-TILLAGE REDUCES YIELD-SCALED NITROUS OXIDE EMISSIONS IN RAINFED MEDITERRANEAN CONDITIONS: A LONG-TERM FIELD AND MODELLING APPROACH**

PLAZA-BONILLA, D.<sup>1,2\*</sup>, ÁLVARO-FUENTES, J.<sup>1</sup>, BARECHE, J.<sup>2</sup>, PAREJA-SÁNCHEZ, E.<sup>2</sup>, JUSTES, E.<sup>3</sup>, CANTERO-MARTÍNEZ, C.<sup>2</sup>

<sup>1</sup> Departamento de Suelo y Agua. Estación Experimental de Aula Dei (EEAD-CSIC), 50080 Zaragoza, Spain; <sup>2</sup> Crop and Forest Sciences Dpt., Unidad Asociada EEAD-CSIC, Agrotecnio, Universidad de Lleida, 25198 Lleida, Spain; <sup>3</sup> CIRAD, UMR SYSTEM, Univ. Montpellier, CIHEAM-IAMM, CIRAD, INRA, Montpellier SupAgro, 34980 Montpellier, France; \*daniel.plaza@pvcf.udl.cat

### **INTRODUCTION**

Nitrogen fertilization is of a paramount importance for crop production. However, the application of excessive N leads to losses of reactive N such as the emission of nitrous oxide (N<sub>2</sub>O) from soils to the atmosphere, contributing to global warming. In Mediterranean rainfed agroecosystems, crop productivity and crop N use are strongly limited by soil water. Consequently, the adoption of water conserving techniques such no-tillage can increase crop yields but also soil N<sub>2</sub>O emissions. We present a combined approach of long-term field data and modelling to analyze the impact of tillage and N rates on yield-scaled N<sub>2</sub>O emissions (YSNE), a joint indicator of productivity and GHG emission, in a site representative of rainfed Mediterranean conditions.

### **MATERIAL AND METHODS**

A field experiment was run from 1996 to 2014 in Agramunt, NE Spain (41°48' 36'' N, 1°07' 06'' E, 330 m asl) comparing two tillage types (CT, conventional intensive tillage; NT, no-tillage) with three mineral N rates (0, 60 and 120 kg N ha<sup>-1</sup>) in a barley monoculture. The area presents mean annual precipitation of 401 mm, PET of 855 mm, and average air temperature of 14.1 °C. The experimental layout consisted of a randomized complete block design with three replications. Soil was classified as Typic Xerofluvent, and presented a pH (H<sub>2</sub>O, 1:2.5) of 8.5 and a loam soil texture (0-30 cm depth). The CT treatment consisted of one moldboard plough pass (25-30 cm depth) plus one or two cultivator passes (15 cm depth) before sowing, while herbicide weed control was used in NT. A third of the N rate was applied before sowing and the rest as top-dressing at the beginning of the tillering stage using ammonium nitrate (33.5% N). The grain was harvested using a commercial combine. Observed soil N<sub>2</sub>O emissions and ancillary variables (soil moisture, temperature, and ammonium and nitrate nitrogen at 0-5 cm depth) reported in Plaza-Bonilla et al. (2014) were used to independently calibrate and evaluate the STICS model (Brisson et al., 2008). Soil N<sub>2</sub>O emissions were quantified during the 2011-2012 cropping season with the use of static chambers and a gas chromatography system equipped with an ECD detector. Crop growth and productivity was calibrated and evaluated with a second dataset comprising soil water and mineral N content (0-90 cm depth) and crop biomass and yield data of the eighteen years covered by the experiment. Soil parameters (from analysis), climatic variables (from the nearest weather station) and management practices were provided as inputs for the simulation. The performance of the model was evaluated with different statistical criteria. After evaluation, soil N<sub>2</sub>O emissions and emission factor (FE) of the 18 experimental years were simulated for each tillage and N rate combination. Finally, the annual YSNE were estimated with the simulated cumulative soil N<sub>2</sub>O emissions and the grain yield measured in the field experiment. An analysis of variance was performed for grain yield with tillage, N fertilization, year and their interaction as sources of variation with the JMP 12 statistical package (SAS Institute Inc, 2015).

### **RESULTS AND DISCUSSION**

Barley grain yield was significantly affected by the tillage x nitrogen x year interaction (p = 0.004). In the first two years of experiment CT led to greater grain yields than NT, while opposite results (NT > CT) were observed in 13 subsequent cropping seasons. In general, crop yield response to N application (i.e. 60 vs 0 kg N ha<sup>-1</sup>) was only observed under NT (in 11 years) (Table 1). That aspect highlights the key role played by soil water conservation on crop performance.

Model efficiency was greater than 0.5 for all ancillary variables with the exception of soil nitrate at soil surface (0-5 cm), which was better simulated at the plough layer (0-30 cm depth). STICS performed reasonably well when simulating the dynamics of soil moisture with some overestimation in CT values. Surface soil (5 cm) temperature was well simulated by the model, independently of the treatment. The model adequately responded to the application of fertilizer with an increase in soil ammonium (0-5 cm) levels similar than the observed. The comparison between observed and simulated cumulative N<sub>2</sub>O emission during the 2011-2012 barley growing season led to a model efficiency of 0.83. According to the model simulations cumulative N<sub>2</sub>O emissions would be greatly affected by the irregularity of precipitations and N rate, with a minor impact of tillage systems (Table 1). In this line, Plaza-Bonilla et al. (2017) showed the ability of the STICS model to cope with the effects of interannual climatic variability on soil N<sub>2</sub>O emissions under temperate conditions of SW France. Simulated mean N<sub>2</sub>O EF was similar between tillage treatments, and only exceeded the IPCC default value of 1% in the NT-60 and NT-120 treatments in three and 1 out of 18 years, respectively. The mean YSNE would be 3 times greater under CT compared to NT, and would increase when increasing the N fertilizer rate (Table 1).

*Table 1. Barley grain yield, simulated cumulative N<sub>2</sub>O emissions and yield-scaled N<sub>2</sub>O emissions as affected by tillage (CT, conventional tillage; NT, no-tillage) and N fertilization rate (0, 60 and 120 kg N ha<sup>-1</sup>) in a rainfed semiarid Mediterranean location. Values are means of 18 years. Values between brackets correspond to the standard deviation.*

Variable	Treatments					
	CT-0	CT-60	CT-120	NT-0	NT-60	NT-120
Grain yield (kg DM ha <sup>-1</sup> )	1455 (1232)	1532 (1243)	1590 (1228)	1601 (782)	2248 (894)	2426 (878)
Cumulative N <sub>2</sub> O emission (kg N <sub>2</sub> O-N ha <sup>-1</sup> yr <sup>-1</sup> )	0.50 (0.4)	0.82 (0.4)	1.09 (0.6)	0.53 (0.5)	0.92 (0.6)	1.19 (0.7)
Yield-scaled N <sub>2</sub> O emissions (g N <sub>2</sub> O-N kg <sup>-1</sup> grain)	1.25 (2.4)	1.58 (2.4)	2.11 (3.7)	0.45 (0.5)	0.56 (0.6)	0.63 (0.5)

## CONCLUSION

Lower yield-scaled nitrous oxide emissions under no-tillage represents a win-win strategy for the relationship between agricultural productivity and environmental sustainability of rainfed Mediterranean agroecosystems.

**Acknowledgements:** This work was supported by projects AGL 2010-22050-C03-01/02 and AGL2013-49062-C4-1/4-R and DPB postdoctoral grant (ref. FJCI-2014-19570) from the Ministerio de Economía, Industria y Competitividad of Spain.

## REFERENCES

- Brisson N., Launay M., Mary B., Beaudoin N., 2008. Conceptual basis, formalisations and parameterization of the STICS crop model. Editions QUAE, INRA, 78026 Versailles Cedex.
- Plaza-Bonilla D., Álvaro-Fuentes J., Arrúe J.L., Cantero-Martínez C., 2014. Tillage and nitrogen fertilization effects on nitrous oxide emissions in a rainfed Mediterranean area. *Agric. Ecosys. Environ.*, 189, 43-52.
- Plaza-Bonilla D., Léonard J., Peyrard C., Mary B., Justes E., 2017. Precipitation gradient and crop management affect N<sub>2</sub>O emissions: Simulation of mitigation strategies in rainfed Mediterranean conditions. *Agric. Ecosys. Environ.*, 238, 89-103.
- SAS Institute Inc, 2015. Using JMP12. Cary. SAS Institute Inc., NC.

# 20<sup>th</sup> Nitrogen Workshop

## Coupling C-N-P-S cycles

June 25-27, 2018  
Le Couvent des Jacobins, Rennes – France

### **Session IV: Studies and mitigation options at the farm level – Oral presentations**

## KEYNOTE PRESENTATION: SOURCES OF NITROGEN IN CEREAL PRODUCTION AND MITIGATION OPTIONS

Ladha, J.K.

University of California, Davis, USA

### INTRODUCTION

Only about half of the amount of synthetic N applied is actually used by a crop whereas the other half is lost to the environment, greatly increasing environmental problems (Galloway et al 2003). Unlike nonreactive gaseous N<sub>2</sub>, reactive N has magnified the adverse effects because the same atom of N can cause multiple effects in the atmosphere, in terrestrial ecosystems, in freshwater and marine systems, and on human health. Nonetheless in addition to about half of the synthetic N, the crop receives an equal amount of N from the other sources, often assumed to be become available following net N mineralization of soil organic matter (SOM). Numerous short and long-term research trials carried out across the world during last five decades suggested that on an average, the three cereals obtain 48% of its N from synthetic fertilizer and 52% from SOM. If SOM continuously provides 52% of the total N in the crop, the soil N reserve would have been depleted to alarming low level. In contrary, a recent meta analysis of change in SOM-N in 114 cereal-based long-term experiments conducted globally does not show a large decline in SOM-N (Ladha et al., 2011). Instead, soils cropped to cereals have reached more or less a steady state with respect to total SOM-N suggesting that in addition to synthetic N fertilizer, there is another external source(s) of N input in cereal systems. This begs the questions what is the source(s) and magnitude of this source of unaccounted N? Moreover, is the unaccounted pool of N augmented by the application of synthetic N? These questions can only be resolved by constructing a total global N balance for cereals which are key to (1) increasing our understanding of N transformation and N transfers, and (2) quantifying the size of various N reservoirs that are ultimately needed to conserve N in various transformations and biological processes of the system. Addressing these questions are also critical to developing mitigation options to manage N judiciously. This presentation will (1) quantify the various sources of nitrogen (2) evaluate the methods used to determine NUE, (3) determine the key factors that control NUE, and (5) analyze various strategies available to improve the use efficiency at farm level.

### MATERIAL AND METHODS

The N budget was developed by quantifying the inputs and outputs and the change in soil N ( $\partial N$  = final minus initial) over a period of years. Inputs of N included those from fertilizer (FN), manure (MN), residues of crops (RN), atmospheric deposition (DN), seed (SN), and biological fixation (BNF). Outputs include N harvested by the crop (CN) and losses (LN) from various sources through processes such as volatilization, leaching, denitrification, and soil erosion. Thus,

$$N_{budget} = (FN + MN + RN + DN + SN + BNF) - (CN + LN) \pm \partial N$$

In this equation, all the parameters were estimated except BNF, which is uncertain and difficult to measure. We therefore calculated the contribution of BNF using the following equation:

$$BNF = (CN + LN) - (FN + MN + RN + DN + SN) \pm \partial N$$

Estimations of nitrogen harvested by the crops, fertilizer-N input, crop-N derived from fertilizer, loss of fertilizer-N, and the change in total soil-N (30-cm soil depth) are described by Ladha et al., (2017). The SAS mixed procedure with the Tukey-Kramer test was used to determine the variances and to compare the means for the variables. Un-weighted meta-analysis using Meta-Win software (Rosenberg et al 1997) was used to determine the mean and 95% confidence limit.

### RESULTS AND DISCUSSION

A top-down global N budget for maize, rice, and wheat constructed for a 50-year period (1961 to 2010) by integrating global quantities of various sources and sinks of N, which were easier to estimate, rather than assessing N losses, which are highly location and management specific (Ladha et al 2016). A total of 1551 Tg of N were harvested by these cereals during the period, of which 48% was derived from fertilizer-N source and 4% was contributed through net soil depletion (Figure). The remaining 48% (737 Tg) of crop N harvest had sources other than fertilizer- or soil-N, corresponding to 29, 38, and 25 kg ha<sup>-1</sup> yr<sup>-1</sup> for maize, rice, and wheat, respectively. The major source of this N is apparently the non-symbiotic N<sub>2</sub> fixation, contributing 25% of total N in the crop, which is equal to 13, 22, and 13 kg ha<sup>-1</sup> yr<sup>-1</sup> for maize, rice, and wheat, respectively (Ladha et al 2016). Other non-fertilizer and non-soil sources include manure (14%) and atmospheric deposition (6%), while crop residues and seed contribute marginally (2 and 1%, respectively) to the crop N. This finding highlights the need to consider all the sources of N (synthetic, SON, manure/residue, deposition and non-symbiotic BNF) when designing strategies to improve N use efficiency.

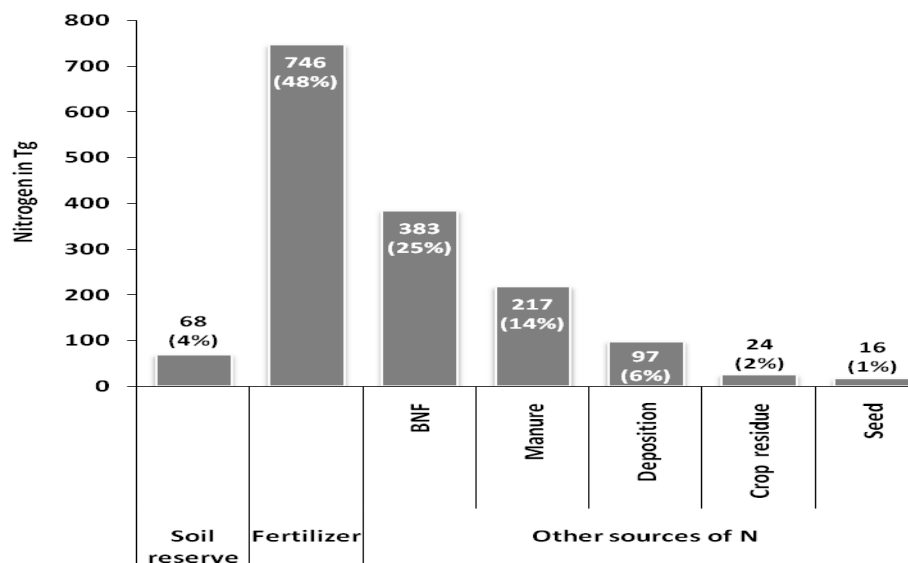

Figure. Global estimates of sources of N in crop harvest of maize, rice, and wheat production systems: total (Tg) for 50 years (1961-2010). Source Ladha et al (2016).

## REFERENCES

- Galloway J. N. et al. (2004) Nitrogen cycles: past, present, and future. *Biogeochem.* **70**, 153-226.
- Greenland DJ. & Watanabe I. (1982) The continuing nitrogen enigma. *Wither Soil Research*, Transactions of the 12<sup>th</sup> International Congress Soil Science. (New Delhi, India).
- Ladha JK et al. (2011) Role of nitrogen fertilization in sustaining organic matter in cultivated soils. *J. Environ. Qual.* **40**, 1756-1766.
- Ladha JK et al. (2016) Global nitrogen budget in cereals: A 50-year assessment for maize, rice and wheat. *Scientific Reports* 6:19355/DOI:1038/screp19355, 1-9.
- Rosenberg, M. S., Adams, D. C. & Gurevitch, J. MetaWin. Statistical software for meta-analysis (Version 2.1) (1997).

## DO AGRICULTURAL PRACTICES IMPACT CARBON, NITROGEN AND PHOSPHORUS STOICHIOMETRY IN PLANTS AND SOILS ON THE LONG-TERM?

FERCHAUD, F.<sup>1</sup>, MARY, B.<sup>1</sup>, KEUPER, F.<sup>1</sup>, MOLLIER, A.<sup>2</sup>, DENOROY, P.<sup>2</sup>, MOREL, C.<sup>2</sup>, GALLET-BUDYNEK, A.<sup>2</sup>, HOUOT, S.<sup>3</sup>, JOUANY, C.<sup>4</sup>, HEDDE, M.<sup>5</sup>, HINSINGER, P.<sup>5</sup>, JOURDAN, C.<sup>5</sup>, BERTRAND, I.<sup>5</sup>

<sup>1</sup>UR AgroImpact, Laon, <sup>2</sup>UMR ISPA, Bordeaux, <sup>3</sup>UMR ECOSYS, Grignon, <sup>4</sup>UMR AGIR, Toulouse, <sup>5</sup>UMR Eco&Sols, Montpellier

### INTRODUCTION

Carbon (C), nitrogen (N) and phosphorus (P) cycles are intimately linked in ecosystems through key processes such as primary production and litter decomposition. Ecological stoichiometry has become a common approach for exploring relationships between biogeochemical cycles and ecosystems functions in ecological science (Sterner and Elser, 2002). In agronomy, the concept of stoichiometry is far less utilized, probably because the addition of fertilizer reduced biotic interactions between the C, N and P cycles. Surprisingly, little is known about the long-term impact of agricultural practices on soil stoichiometry. Within the context of agro-ecology, however, alternative agricultural practices aim to increase nutrient recycling from plant residues, soil organic matter and inorganic reserves (e.g. legacy P), while reducing tillage or mineral fertilizer input. The success of such practices relies on the increase of soil biotic interactions and may impact C storage in soils on the long term, if soil organic matter stoichiometry is constrained (Bertrand *et al.*, submitted).

We aimed at determining the long-term impacts of alternative agricultural practices on plant and soil stoichiometry. To do so, we compiled and completed a dataset of long-term (8-49 yr) field experiments in France in which P or N fertilization rates or tillage intensity was strongly reduced.

### MATERIAL AND METHODS

Data were collected from a set of seven long-term experiments (Table 1). The dataset was completed when needed by re-analysing stored soil and/or plant samples (shoot) for their C, N or P content. Different forms of soil P were investigated: total, organic and Olsen-extractable P. A database was built and statistical analyses of C:N:P ratios were performed intra and inter-sites (analyses of variance).

Table 1: Inventory of the main experimental sites, their duration and the type of treatments

Sites and Location	Duration	Agricultural practices tested
Auzeville (near Toulouse)	1969-2018	0, 11, 22 and 33 kg P ha <sup>-1</sup> yr <sup>-1</sup> applied as superphosphate
Mant (south of Bordeaux)	1975-1991	0, 27, 79 kg P ha <sup>-1</sup> yr <sup>-1</sup> applied as superphosphate on continuous irrigated maize
Carcres Sainte-Croix (south of Bordeaux)	1972-2004	0, 44, 96 kg P ha <sup>-1</sup> yr <sup>-1</sup> applied as superphosphate on continuous irrigated maize
La Cage (Versailles)	1998-2018	4 cropping systems: conventional, low input, conservation agriculture, organic farming
SOERE QualiAgro (Grignon)	1998-2018	Organic fertilizers (4 types) x N fertilization (2 rates)
SOERE ACBB (Estrées-Mons)	2010-2018	Reduced tillage, crop residue removal and reduced N fertilization
Biomass & Environment (Estrées-Mons)	2006-2018	Crop type (perennials vs. annuals) x N fertilization (2 rates)

### RESULTS AND DISCUSSION

The main factor explaining differences in plant stoichiometric ratios (C:N, C:P, N:P) was the type of plant species. Due to their storage capacity and allocation strategy, autotrophs like plants had higher stoichiometric flexibility than is commonly observed for heterotrophs like soil microorganisms. However, agricultural practices affected the C, N and P contents of the plants and their ratios within plant species. For instance, organic farming in La Cage



produced wheat with higher C:N and lower N:P ratios than the conventional system (30.7 vs. 24.4 and 2.5 vs. 3.4 respectively).

The agricultural soils studied presented C:N and C:P ratios ranging from 8 to 14.5 and from 15 to 28 respectively, and N:P ratios ranging from 1.5 to 2.8 (total P). The site effect was significant on the soil CNP contents and ratios (one-way ANOVA,  $P < 0.05$ ). Interestingly, whereas the soil C:N ratios were constrained and not influenced by the different agricultural practices, in agreement with Zinn *et al.* (2018), the C:P and N:P were more flexible. E.g., at the Mant and Carcares Sainte-Croix sites we observed stable C:N ratios, whatever the treatment and duration of the experiments, while flexible C:P and N:P ratios were observed in response to both treatment and time (Figure 1).

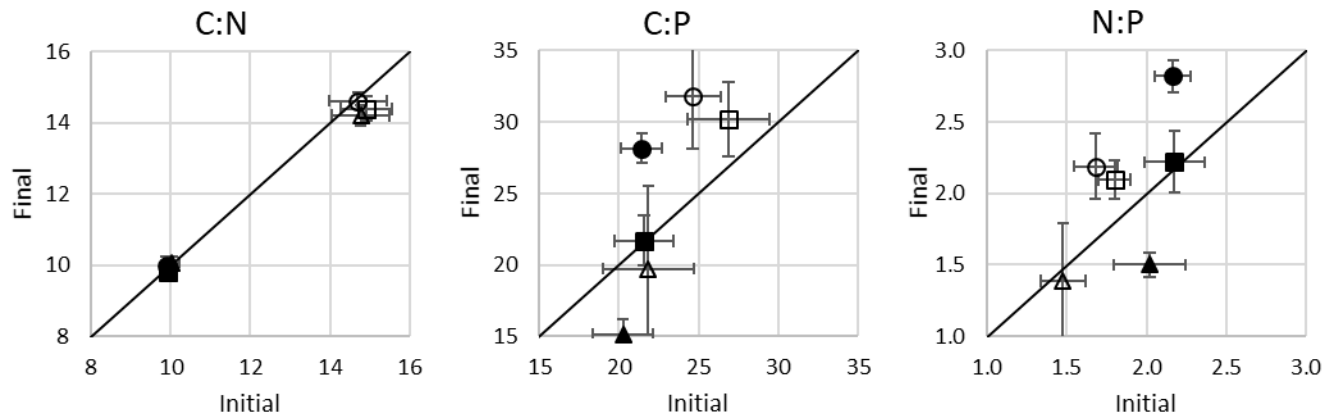

Figure 1: Initial and final C:N, C:P and N:P ratios at Mant (dark symbols, 17 years) and Carcares Sainte-Croix (light symbols, 22 years) in the 0-25 cm soil layer for three levels of P fertilization (P0: circles; P1: squares; P3: triangles)

## CONCLUSION

Overall, plant stoichiometry was less constrained than soil stoichiometry in all studied agricultural systems. Specifically, soil C:N ratios were highly constrained and not influenced by long-term agricultural practices. This stability confirms the strong association between C and N in soil organic matter and the statement by Van Groenigen *et al.* (2017) that storing C in soils will increase N-requirements. Interestingly, however, this was not the case for P, and we show here for that agricultural practices can influence soil C:P and N:P ratios.

**Acknowledgements:** The authors would like to thank the department Environment and Agronomy of INRA for its financial support.

## REFERENCES

- Bertrand, I., Viaud, V., Daufresne, T., Pellerin, S., Recous, S. Storing C while reducing nutrient inputs: Could stoichiometry limit the efficiency of agroecological practices? *Submitted*.
- Li, X., Wang, H., Gan, S.H., Jiang, D.Q., Tian, G.M., & Zhang, Z.J. (2013). Eco-Stoichiometric Alterations in Paddy Soil Ecosystem Driven by Phosphorus Application. *Plos One*, 8.
- Sterner, R.W. & Elser J.J. (2002) *Ecological Stoichiometry: Biology of Elements from Molecules to the Biosphere*. Princeton, NJ, USA: Princeton University Press, <https://doi.org/10.1093/plankt/25.9.1183>
- Van Groenigen, J.W., Van Kessel, C., Hungate, B.A., Oenema, O., Powlson, D.S., & Van Groenigen, K.J. (2017). Sequestering Soil Organic Carbon: A Nitrogen Dilemma. *Environmental Science and Technology*, 51, 4738–4739.
- Zinn, Y.L., Marrenjo, G.J., & Silva, C.A. (2018). Soil C:N ratios are unresponsive to land use change in Brazil: A comparative analysis. *Agriculture, Ecosystems and Environment*, 255, 62–72.

## IDENTIFYING NEMO: A MODEL-BASED METHODOLOGY TO IDENTIFY STRATEGIC N APPLICATION RATES FOR RAINFED CROP

PATTEY, E.<sup>1</sup>, MESBAH, M.<sup>2</sup>, JEGO, G.<sup>3</sup>

<sup>1</sup> Agriculture and Agri-Food Canada, 1Ottawa, ON, Canada; <sup>2</sup> Charlottetown, PEI Canada; <sup>3</sup> Quebec, QC, Canada

### INTRODUCTION

Identifying the right amount of nitrogen (N) fertilizer for crop production is critical for limiting N loss to the environment (Galloway et al., 2003). Applying N rates higher than the crop needs contributes to the release of reactive N in the environment through nitrate leaching, ammonia volatilization and nitrous oxide emissions. Because the optimum amount of N ( $N_{opt}$ ) applied varies not only with soil properties but also with climatic conditions, finding the appropriate N recommendation is particularly challenging for rainfed crops with high N demand such as corn (*Zea Mays* L.). Developing a methodology to account for daily and interannual climate variations in the determination of  $N_{opt}$  is a key step towards delivering an integrated decision support system for N rate recommendations that mitigate reactive N losses. Modeling is envisioned as a way to test yield response to N rates with small increments (e.g.,  $10 \text{ kg N ha}^{-1}$ ) for several climatic years (e.g., 30-60 years) and for given soil properties (dominant soil classes for the region of interest). Therefore, adapting and verifying a crop model for the region of interest is important before yields predicted by the selected model can be used to study  $N_{opt}$ . The STICS crop model (Brisson et al., 2003) met these requirements (Jégo et al. 2011, 2015) and was selected to introduce the methodology and a case study of corn production in eastern Canada. Our objectives were (1) to propose a new yield function and evaluate its performance compared to existing yield functions; (2) to propose a methodology, called Identifying NEMO, to derive  $N_{opt}$  based on the crop ecophysiology; (3) to derive recommended N rates as a function of expected yield probability, and N excess or deficit by region.

### MATERIAL AND METHODS

A slope-based method is proposed to identify, for a given region and soil, the optimum N use efficiency ( $NUE_{opt}$ ) and to determine the corresponding  $N_{opt}$  for each growing season. A case study was carried out in five 40 x 40 km regions (ON: Windsor, London, Ottawa; QC: Saint-Hubert, Quebec City) of the Mixedwood Plains ecozone of Canada, which contributes more than 90% of the corn production in Canada. At each location, 50+ years of daily climatic data were available. The three most dominant and contrasting soil textures were selected in each region by overlaying the corn cultivated areas issued from the 2013 space-based crop identification map to the soil map from the Canadian Soil Information System, as soil parameter input to the model. The simulations over the long daily climatic series using the STICS model to predict corn yields were carried out with region-specific seeding dates and corn cultivars. For each climatic year, soil and region, yields were predicted for N rates varying between 50 and 200  $\text{kg N ha}^{-1}$  by step of  $10 \text{ kg N ha}^{-1}$  except for clay and silty clay soil, for which the range was between 100 and 250  $\text{kg N ha}^{-1}$ . The case study involved more than 14800 simulations. The performance of the following yield functions was evaluated: the linear-plateau (L-P), which accounts for the fact that yield reaches plateau; Mistcherlich Baule (MB) functions, which accounts for the nonlinearity associated with yield response to N rates, both are among the most commonly used functions, and a new combination, the Mistcherlich Baule-Plateau (MB-P) function.

### RESULTS AND DISCUSSION

The choice of a proper yield function is very important as misspecification of the function could lead to misleading results. To evaluate the yield functions performance, they were fitted to the predicted yield data for each year. The three yield functions perform very well at high and medium yield years, whereas the performance of the nonlinear functions (MB, and MB-P) deteriorates at lower yield level when the response of yield to N becomes almost linear. However, when the slope of the functions at fine resolution N rate intervals were compared to the

central finite difference values for predicting NUE, the MB-P function showed a slightly better performance and was thus selected for identifying  $N_{opt}$  (Mesbah et al. 2017).

The proposed method is similar to the economic approaches as it analyzes the slope of yield function to N rate. However, the optimum slope and corresponding N rate is defined based on the crop ecophysiological performance. This  $NUE_{opt}$  is identified by evaluating the linearity of the relationship between yield and  $N_{opt}$ , and the reduction in yield compared to maximum achievable yield for a given soil and various growing seasons. The steps taken to determine the  $NUE_{opt}$  are as follows (Mesbah et al. 2017):

- 1) The selected crop model is used to simulate yield response to various N rates using fine increments in the interval of interest (i.e.,  $10 \text{ kg N ha}^{-1}$ ) for a long time series of climatic data and relevant soil properties.
- 2) A regression is performed to fit the MB-P function, to the data of fine resolution N rates and corresponding dry yield predicted by the crop model for each growing season and soil properties.
- 3) In order to identify the  $NUE_{opt}$ , a series of yield- $N_{opt}$  data are extracted over a range of NUE values. This yield- $N_{opt}$  dataset is unique for each NUE, and is generated using the fitted MB-P functions and the selected NUE.
- 4) For a given NUE, a linear regression is performed to evaluate the linearity between yield and  $N_{opt}$  data.  $NUE_{opt}$  is reached when a linear relationship is obtained.
- 5) For the given NUE, the ratios of yield at  $N_{opt}$  to maximum yield as well as the yield reduction (i.e., the difference between maximum yield and yield at  $N_{opt}$ ) are calculated for each growing season. The mean values for high yield years, and low yield years are then calculated separately and used to study the relationship between NUE and reduction in yield.
- 6) Steps 4 to 5 are repeated for all NUEs in the predefined NUE range.
- 7) A tradeoff plot is then constructed to show how yield reduction (calculated in step 5) and  $R^2$  and RMSE of linear fit (step 3) change by NUEs. The tradeoff plot can then be used to decide on an NUE that meets two criteria: (1) it leads to a good linear relationship between  $N_{opt}$  and dry yield, and (2) it leads to marginal reduction in maximum achievable yield.

For an expected level of yield and a selected NUE, the corresponding linear relationship between yield and  $N_{opt}$  is used to derive a recommended level of N rate. For the given expected yield, the distribution  $N_{opt}$  and yield predicted by the crop model is also used to calculate the chance of achieving an expected yield, as well as the N excess or deficit for the region of interest.

## CONCLUSION

The performance of the proposed methodology, Identifying NEMO, was examined via a case study of multiple regions along with the Mixedwood Plains ecozone. Our results indicated that this methodology could provide valuable information on beneficial N management practices under various climatic conditions and soil textures.

## REFERENCES

- Brisson N., Gary C., Justes E., Roche R., 2003. An overview of the crop model STICS. *Eur. J. Agron.* 18, 309–332.
- Galloway J.N., Aber J.D., Erisman J.W., Seitzinger S.P., Howarth R.W., Cowling E.B., Cosby B.J., 2003. The nitrogen cascade. *Bioscience* 53, 341–356.
- Jégo G., Pattey E., Bourgeois G., Drury C.F., Tremblay N., 2011. Evaluation of the STICS crop growth model with maize cultivar parameters calibrated for Eastern Canada. *Agron. Sustain. Dev.* 31, 557–570.
- Jégo G., Pattey E., Mesbah M., Liu J., Duchesne I. 2015. Impact of the spatial resolution of climatic data and soil physical properties on regional corn yield predictions using the STICS crop model. *Int. J. Appl. Earth. Obs. Geoinf.* 41, 11-22.
- Mesbah M., Pattey E., Jégo G. 2017. A model-based methodology to derive optimum nitrogen rates for rainfed crops – a case study for corn using STICS in Canada. *Comput. Electron. Agric.*, 142 (Part B), 572-584.

## **AMMONIA EMISSION FROM ANIMAL MANURE AND MINERAL FERTILIZER MEASURED WITH A CHEAP, RELIABLE & SIMPLE TO USE METHOD**

SOMMER, S.G.<sup>1</sup>, KURE, J.L.<sup>1</sup>, KRABBEN, J.<sup>1</sup>, DUELUND L.<sup>1</sup>, PEDERSEN, S.V.<sup>1</sup>

<sup>1</sup>University of Southern Denmark (SDU), Faculty of Engineering, Department of Chemical Engineering, Biotechnology and Environmental Technology, Campusvej 55, 5230 Odense M, Denmark

### **INTRODUCTION**

Emission of ammonia (NH<sub>3</sub>) from agriculture is a loss to the farmer, detrimental to the environment (Sutton et al., 2011) and a risk to health. Manure or fertilizers applied in the field are one of the main sources of NH<sub>3</sub> in the atmosphere, and in Europe, agriculture must reduce the emission to the levels given by the NEC Directive. The acceptance of new low emission technologies to manage manure and mineral fertilizer as so-called best available technologies relies on valid estimates of the reduction efficiency. Ammonia volatilization from plots or fields are measured using micrometeorological techniques or portable wind tunnels, and the atmospheric NH<sub>3</sub> concentration is measured with methods, that capture or absorb NH<sub>3</sub> in acids and the amount absorbed is determined with the Berthelot colouring reaction.

There is a need to measure NH<sub>3</sub> emission from manure or fertilizers applied to fields with different soil characteristics and crop cover, and at varying climate conditions. This may be impeded by costs related to existing measuring methods; therefore, there is a need for cheap and reliable measuring technologies that can be used by technicians with no experience in measuring NH<sub>3</sub> emission. We propose that a specialized center could provide the anemometers, NH<sub>3</sub> samplers and instruction to users. Passive ALPHA samplers is proposed as the NH<sub>3</sub> measuring technique; these can be prepared for measurements, be stored for long periods in closed PVC bags without being polluted and be send by post. The ALPHA method was developed for long-term exposure (weeks), and exposure periods are from 4 – 24 h in the experiments measuring NH<sub>3</sub> emission from field plots. The intention of this study is to adapt and test the samplers for measuring NH<sub>3</sub> emission from relative small field plots amended with manure or mineral fertilizers.

### **MATERIAL AND METHODS**

We examined the effect of oxalic and citric acid on the precision and reproducibility of measurements with a NH<sub>4</sub>-electrode and compared these with measurements using the Berthelot colouring method. The tests was carried out using standards containing a solution of ammonium chloride (NH<sub>4</sub>Cl) and oxalic or citric acid mimicking eluates from ALPHA samplers. A series of test with the electrode was carried out to provide instruction about use, and information about detection limit, precision and reproducibility. Precision, reproducibility and detection limit of measurements of NH<sub>3</sub> gas concentration was were determined using samplers exposed in a chamber through which air with NH<sub>3</sub> was pumped, and by measuring NH<sub>3</sub> concentration/flux with samplers exposed in the field and compared this to concentration/flux measured with Leuning flux samplers. Data are being analysed at the moment of submission this abstract and will be presented at the workshop, a few introductory results are presented here.

### **RESULTS AND DISCUSSION**

The absorbance (Berthelot colouring) was affected by the acids in solution with TAN, and reduced the reproducibility of the measurements compared to measuring TAN dissolved in water (Fig. 1A). This was not the case when measuring the signal (charge) of TAN in solutions with and without addition of acids using the electrode, indicating that the acids do not affect the ion specific electrode, if the amount of OH<sup>-</sup> added to the solution is high enough to release NH<sub>3</sub>. Further, samples from field experiments indicated that the CV of

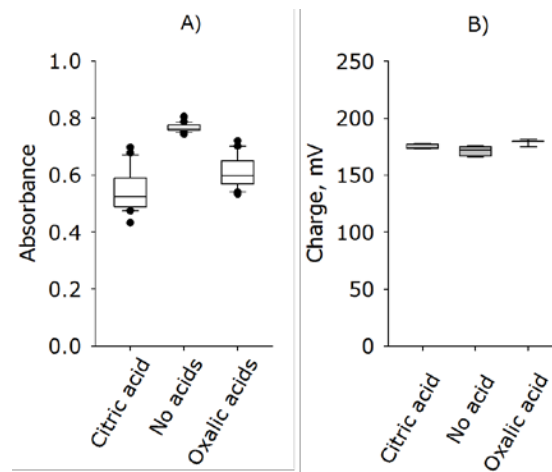

Figure 1. Reproducibility of the analysis of  $\text{NH}_4^+$  in eluate from absorbers as affected by acids in eluate (TAN  $50 \mu\text{M}$  and acid  $101 \text{ mM}$ ). A: absorbance (Berthelot color reaction) and B: charge (ammonium electrode).

the mean varied from 4 to 15% (number of replicates was 4), which is similar to that for gas washing bottles used to measure  $\text{NH}_3$  concentrations in air above plots amended manure or fertilizers.

Emission is calculated by knowing  $\text{NH}_3$  concentration and wind speed using the bLS method or by measuring the  $\text{NH}_3$  flux at the zinst height ( $H_{ZINST}$ , m) and multiplying this flux with a constant ( $K_{ZINST}$ ), which has been given for larger plots by Wilson et al. (1982). We have calculated the  $H_{ZINST}$  and  $K_{ZINST}$  for small plots (Table 1).

Table 1. The height  $H_{ZINST}$  at which normalized horizontal flux deviate little at different atmospheric stabilities. The height is calculated at Monin Obukov length 10 m, -10 m and 100000 m ( $\infty$  m) using the Windtrax model.

Surface characteristic	Surface roughness ( $Z_0$ , cm) <sup>a</sup>	Radius 5 m		Radius 20 m	
		$H_{ZINST}$ (m)	$K_{ZINST}$	$H_{ZINST}$ (m)	$K_{ZINST}$
Harrowed – no obstacles	0.5 <sup>b</sup>	No result	No result	0.9	9.5
Newly plowed, Grass 3-5 cm Wheat stubble field (5-10 cm stubble)	2	0.5	4.9	1.1	8.6

Feed lots	3.6 (2-6)	0.6	4.3	1.5	6.4
Wheat 5-10 cm	5 <sup>b</sup>	1	2.1	2	4.3
Wheat 0.5-1 m	10 <sup>b</sup>	No result	No result	2	5

---

## CONCLUSION

The diffusion samplers developed for measuring NH<sub>3</sub> concentrations over long time intervals provide precise and reproducible measurements for shorter term measuring intervals (>6 h) and for plots with a fetch of 5 m. This measuring technique can reduce cost for measuring emissions and the use of small plot provide opportunities for replicated measurements of a treatment in the same field.

## REFERENCES

- Sutton, M. A., Oenema, O., Erisman, J. W., Leip, A., van Grinsven, H. & Winiwarter, W. 2011. Too much of a good thing. *Nature - Comment* 472, 159–161.
- Wilson, J.D., G.W. Thurtell, G.E. Kidd, and E.G. Beauchamp. 1982. Estimation of the rate of gaseous mass transfer from a surface source plot to the atmosphere. *Atmos. Environ.* 16:1861–1867.

## NITROGEN USE EFFICIENCY AS AN INDICATOR OF FARM PERFORMANCE

QUEMADA, M.<sup>1</sup>, BRENTROP, F.<sup>2</sup>, RUTKOWSKA, L.<sup>3</sup>, STOUMANS, L.<sup>4</sup>, SCHULMAN, M.<sup>5</sup>, OENEMA, O.<sup>6</sup>

<sup>1</sup> Universidad Politécnica de Madrid, Spain; <sup>2</sup> Yara International, Research Centre Hanninghof, Germany, <sup>3</sup> Institute of Soil Science and Plant Cultivation, Poland, <sup>4</sup> University of Copenhagen, Denmark; <sup>5</sup> COPA COCEGA, EU; <sup>6</sup> Wageningen University, The Netherlands

### INTRODUCTION

Nitrogen management in farms aims at improving agronomic objectives and minimizing environmental impacts simultaneously. But proper management is not easy because the N cycle is complex and the risk of losses from the farm to the environment high. Therefore, indicators for the performance of farms can play a relevant role in improving N management. Nitrogen use efficiency (NUE) is commonly used to assess the relative conversion of N inputs into agricultural products [1], but there is not systematic monitoring of NUE at farm level and hence little is known about differences in NUE between farms and regions. The objective of this study was to apply N performance indicators to different farms across Europe, and to understand the factors that contribute to differences in NUE and derive possible target values.

### MATERIAL AND METHODS

Farm level data were collected through surveys in Mediterranean, Central Europe, Scandinavia and Western Europe. The data were analysed to calculate three related indicators (NUE, N output and N surplus) according to the procedure described by the EU Nitrogen Expert Panel. Briefly, N input and N output data were collected from each farm, and a farm N balance was estimated according to Table 1. In the case that animal manure was imported to the farm and other manure exported, only the net manure N input was reported as input.

For each farm, NUE was calculated as the ratio of outputs over inputs. The N output (kg N ha<sup>-1</sup>) was estimated from the amount of products harvested times the mean N content of the particular products, and is an indicator of farm productivity. The N surplus (kg N ha<sup>-1</sup>) was calculated as the difference between the inputs and the outputs, and is a commonly used indicator for assessing the potential N losses to the environment.

A simple software tool was developed in Microsoft Excel to process the collected information in a uniform way. Results of the NUE, N output and N surplus of the different farm types and regions were statistically analysed using multiple regression analysis. Finally, farm data were mapped into a two-dimensional framework of N output versus N input suggested by the EU N Panel that combines the N performance indicators.

*Table 1. Input and output items considered for the farm N balance and the calculation of NUE, N output and N surplus.*

<b>Nitrogen input items</b>	<b>Nitrogen output items</b>
Mineral fertilizers	Crop products
Feed and fodder (net)	Animals (net)
Biological nitrogen fixation	Animal products (milk, egg, wool, meat, ...)
Atmospheric N deposition	Orchard trees (net)
Compost and sewage sludge	
Seed and planting material	
Bedding material (straw, saw dust)	
Animal manure (net)	
Irrigation water	

### RESULTS AND DISCUSSION

Results show a remarkable variation in NUE and N surplus, which were mainly related to differences in farming system and management. Nitrogen output differed between regions, mainly due to differences in climate and farming systems. Arable farms had higher NUE and N output and lower N surpluses than dairy farms.

Combining NUE with indicators of productivity and environmental losses provided a reliable assessment of N performance at a farm level, as shown by arable farms from Mediterranean Europe (Fig. 1). A high NUE does not necessarily lead to a low risk of environmental impact, consequently in some highly intensive systems a large N surplus was observed. Low NUE was often related to large N losses but it may also indicate that farm productivity (N output) was compromised by other factors.

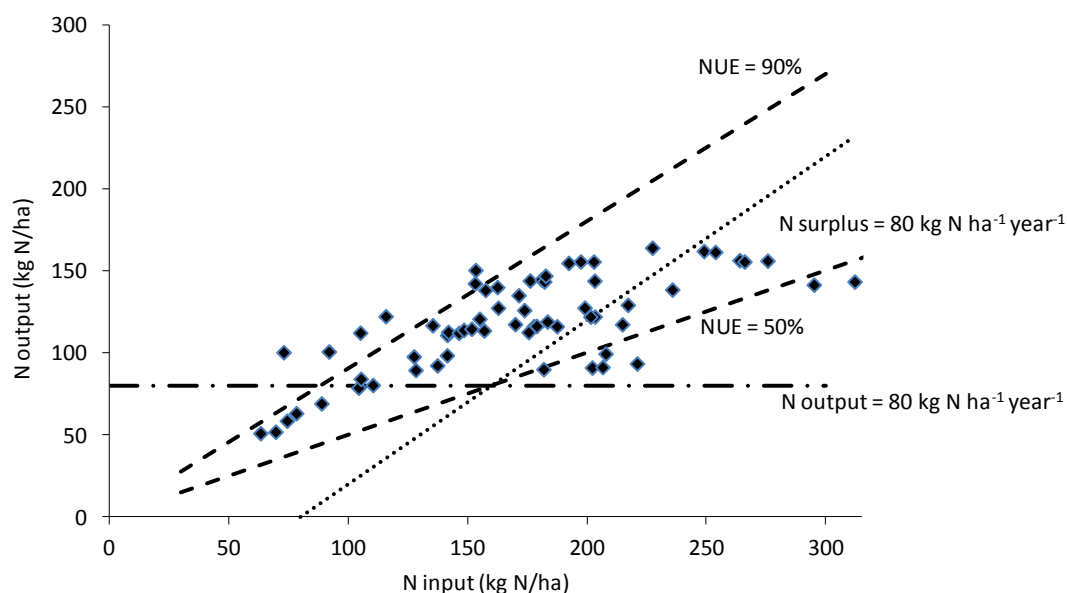

Figure 1. Example of annual N input and N output values of 64 irrigated arable farms in Central Spain mapped onto the framework proposed by the EU Nitrogen Expert Panel.

Some arable farms with  $NUE > 1$  showed a risk of soil mining. Changes in soil organic N are common following conversion of permanent grassland to arable land, changes in cultivation practices (tillage, manure application) and modifications in weather conditions. Given the relevance of soil organic N and its implications on soil C, it is recommended that reports on NUE at farm level include a discussion about potential changes in soil N stock.

## CONCLUSIONS

Optimum targets for N performance would be those aiming for high NUE while minimising N surplus without compromising productivity. Differences in NUE and N surplus between farms in Europe are mainly related to differences in farming systems and management, and less to differences in regions. Farm system specific target values for NUE, farm specific guidance, and possible linkages with the Common Agricultural Policy may create the necessary incentives to further enhance NUE at farm level.

**Acknowledgements:** Fertilizers Europe for supporting the European N Expert Panel activities.

## REFERENCES

EU Nitrogen Expert Panel, 2015. Nitrogen Use Efficiency (NUE) - an indicator for the utilization of nitrogen in agriculture and food systems. Wageningen University, The Netherlands, 47 p.



## **AQUAPONICS SYSTEM, A SOLUTION TO LIMIT NUTRIENT RELEASE BY FISH FARMING?**

JAEGER, C.<sup>1</sup>, FOUCARD, P.<sup>2</sup>, TOCQUEVILLE, A.<sup>2</sup>, NAHON, S.<sup>3</sup>, AUBIN, J.<sup>1</sup>

<sup>1</sup> INRA UMR SAS, France; <sup>2</sup> ITAVI aquaculture department, France, <sup>3</sup> INRA UMR NuMéria

### **INTRODUCTION**

In terrestrial agriculture, the use of manure as fertilizer is a sustainable way to provide nutrient to plants. Similarly, aquaponics is an integrated aquaculture system in which fish farming and soilless culture are combined to recycle nutrient. As dissolved nutrient generally released in wastewater from fish culture is recovered into edible plants thus Aquaponics System (AS) can be considered as a sustainable production system (Graber & Junge, 2009). AS is historically set up as a Recirculating Aquaculture System (RAS) for fish rearing connected to a Hydroponic System (HS) for crop cultivation, sparing use of water (Love et al., 2014). The aim of this study was to assess AS efficiency in fish waste treatment, through a nutrient budget of total Nitrogen (TN) and total Phosphorus (TP), in an operational farm.

### **MATERIAL AND METHODS**

The experiment lasted 52 days inside a single greenhouse. A total of 1001 common carp (*Cyprinus carpio*) (mean weight = 647 g) were stocked to reach a rearing fish density in accordance with usual commercial fish farming densities, and fed with commercial pelleted feed (32% crude protein, 9% crude fat and 1% phosphorus of the fresh weight). Pelleted feed was delivered at a mean ration of 1.1 kg feed/100 kg fish biomass. For the HS compartment, four culture areas of 4.8 m<sup>2</sup> each were composed of bed raft (volume = 550 l) covered by floating rafts (extruded polystyrene foam) set at a density of 16 seedlings/m<sup>2</sup>. Lettuce oak leaf and Batavia were set up in equal numbers at a four leaves stage. Water was continuously running through the bed raft (under the floating rafts) at a flow rate of 1 m<sup>3</sup>/h, then went back to a common tank. From this common tank, water was distributed between the HS, the RAS and the discharge wastewater. In the RAS, water from the 4 fish rearing tanks (3.7 m<sup>3</sup> each) was continuously running through the entire system. A rotary drum filter with a mesh of 60 µm caught the solid particles from water and sent them into a settling tank to concentrate them into sludge. Sludge was then transferred to a second tank in which flocculating agent was added, then sent into a water permeable geotextile bag. At the exit of the drum filter, filtered water entered into the common tank in which new water was added at a 6% water exchange rate per day. In the RAS, water was pumped from this common tank through a UV filter until it reached a moving bed biofilm reactor (MBBR) and finally closed the loop by return flow to the rearing tanks.

Total Nitrogen (TN) and Total Phosphorus (TP) concentrations were analysed, at the beginning and at the end of the experiment, in lettuce, sediment, leachate from sludge and water. Water samples were collected from the tap water, the common tank and the discharge waste water. TN and TP concentrations were measured using spectrophotometry, (ISO 5663:1984 and ISO 6878:2004 respectively). In pelleted feed and lettuce, TN content was determined using an Elementar Vario Pyrocube elemental analyzer (Elementar, Langensfeld, Germany). TP content was determined by the molybdate-blue/ascorbic acid method at 820 nm after mineralization and acid digestion (AFNOR, 1992). In fish, TN and TP contents were estimated according to literature available (Schreckenbach, Knosche, & Ebert, 2001). Volumes and quantities of all these compartments were recorded in order to calculate a nutrient budget for N and P.

### **RESULTS AND DISCUSSION**

Pelleted feed and stocked fish (tab. 1) were the most important inputs in N and P, equivalent to 92.5% and 96.9% of the TN and TP input respectively. N was mainly released from AS through the outlet water whereas P was mainly released through the sediment. The N budget was not well balanced as 24.5% of TN input was not recovered. N gaseous emissions might explain this result (Ru et al., 2017). The N retention rate in fish and lettuce biomass gain represented 18.7% and 0.6% of N delivered by the formulated feed respectively. The P retention rate in fish and

lettuce biomass gain represented 19.9% and 0.7% of TP delivered by the formulated feed respectively. As P is a conservative element and according to uncertainties of measurement and sampling, we consider that the nutrient budget for this element is well balanced. Indeed, 6.6% of P input was not recovered.

*Table 1: quantities of nitrogen and phosphorus, inputs and outputs, in the different compartments of the aquaponics system used for nutrient balance calculation of nitrogen and phosphorus.*

Compartments	Nutrient (g)	
	Nitrogen	Phosphorus
<b>Inputs</b>		
Feed	25 047	4 403
Stocked fish	16 613	3 108
Circulating water at beginning	2 592	213
Inlet water	496	5
Lettuce seedlings	21	2
<b>Outputs</b>		
Harvested fish	21 292	3 984
Outlet water	7 549	975
Circulating water at end	2 427	324
Sediment	2 076	1 741
Harvested lettuce	174	32
Leachate	254	166
Unaccounted: Input-Output	10 997	509

## Conclusion

Considering the very low N and P uptake by plants, we can conclude that AS ability to recover nutrients in plant biomass is limited. Nevertheless, it seems necessary to reconsider the design of the AS in order to maximize the bioremediation potential through optimization of the plants/fish ratio.

**Acknowledgements:** The present work was performed within the French project APIVA (AquaPonie Innovation Végétale et Aquaculture). We thank the RATHO team, for providing the space in their horticultural greenhouse; Philippine Sotteau and Manon Lorriaux for their involvement in the data collection; and A. surget (INRA, NuMeA) for her collaboration in Phosphorus analyzes.

## REFERENCES

- Graber, A., & Junge, R. (2009). Aquaponic Systems: Nutrient recycling from fish wastewater by vegetable production. *Desalination*, 246(1-3), 147-156.
- Love, D. C., Fry, J. P., Genello, L., Hill, E. S., Frederick, J. A., Li, X. M., & Semmens, K. (2014). An International Survey of Aquaponics Practitioners. *Plos One*, 9(7).
- Ru, D. Y., Liu, J. K., Hu, Z., Zou, Y. N., Jiang, L. P., Cheng, X. D., & Lv, Z. T. (2017). Improvement of aquaponic performance through micro- and macro-nutrient addition. *Environmental Science and Pollution Research*, 24(19).
- Schreckenbach, K., Knosche, R., & Ebert, K. (2001). Nutrient and energy content of freshwater fishes. *Journal of Applied Ichthyology*, 17(3), 142-144.

## **A COMPARATIVE NITROGEN BALANCE OF NOVEL CROPPING SYSTEMS FOR FEEDSTOCK PRODUCTION TO FUTURE BIOREFINERIES: THE ROLE OF PERENNIAL GRASSES AND GRASS-LEGUMES**

MANEVSKI, K., LÆRKE, P.E., JØRGENSEN, U.

Arhus University Centre for Circular Bioeconomy (<http://cbio.au.dk/en/>)

### **INTRODUCTION**

Amid the “bio-based” reindustrialisation of the EU, agricultural lands are subject to changes for a variety of economic and environmental reasons. Understanding the effects of new cropping systems on soil nitrogen (N; and carbon, C) dynamics is crucial to evaluate crop production and quality, as well as environmental impacts, and these are yet to be studied. This work reports the first N balances for novel cropping systems optimised for high production to target biomass supply to future biorefineries, under north-European pedo-climatic settings.

### **MATERIAL AND METHODS**

In a three-years study (2013-2015), two types of novel systems, *i*) an optimised rotation with annual crops (maize, beet, hemp/oat, triticale as main crops, and winter rye and oilseed rape as second crops) and *ii*) perennial grasses: highly fertilised (festulolium, reed canarygrass, tall fescue and cocksfoot), low-fertilised (miscanthus) and unfertilised (grass-legume mixtures), were compared with traditional systems (continuous maize or triticale, and a cereal crop rotation) on sandy loam and coarse sand soil in Denmark. Harvested biomass N, soil nitrate dynamics and model-supported nitrate leaching, atmospheric N fixation and apparent soil N balances (inputs minus outputs) of the systems were compared (Manevski et al., 2018).

### **RESULTS AND DISCUSSION**

Relative to continuous maize, the most production-competitive traditional system, fertilised grasses doubled biomass N, and unfertilised grass-legume mixtures yielded similar biomass N, whereas nitrate leaching was reduced by 70-80% (Fig. 1). These perennial systems have been documented to enhance radiation utilisation and biomass production (Manevski et al., 2017), perform well in life cycle assessments (Parajuli et al., 2017) and have higher contents of protein (with better quality, e.g., high lysine and methionine contents) than traditional crops (Solati et al., 2018), making them particularly interesting to substitute the environmentally costly imports of soya bean protein. The optimised crop rotation supplied 70% more biomass N with 40% less nitrate leaching on coarse sandy soil, whereas on sandy loam soil it yielded about 10% less biomass N but leaching was halved, relative to continuous maize. Double-cropping (main and second crop), as well as planting dates, irrigation and N management, are crucial to increase radiation interception, N uptake and high yields (Manevski et al., 2017).

The soil N balance indicated soil N mining for festulolium and continuous maize on sandy loam soil (Fig. 1); on coarse sand soil, lower yield and larger N leaching indicated overfertilisation or unsynchronised irrigation. Inclusion of soil layers down to 1 m will clarify if and how much soil C and N have accumulated beneath the perennial systems based on 5 years (2012-2017), and may explain the apparent discrepancy between the N balance results (soil N mining; Fig. 1) and the soil C/N change (no apparent change for some systems; Table 1)

### **CONCLUSION**

The results may support management of economic and sustainable feedstock production for biorefineries where biomass N can be produced and refined to valuable products. While additional soil C and N data will come, the experiment continues on sandy loam soil site, in addition to a clayey soil site established in 2015 in Denmark.

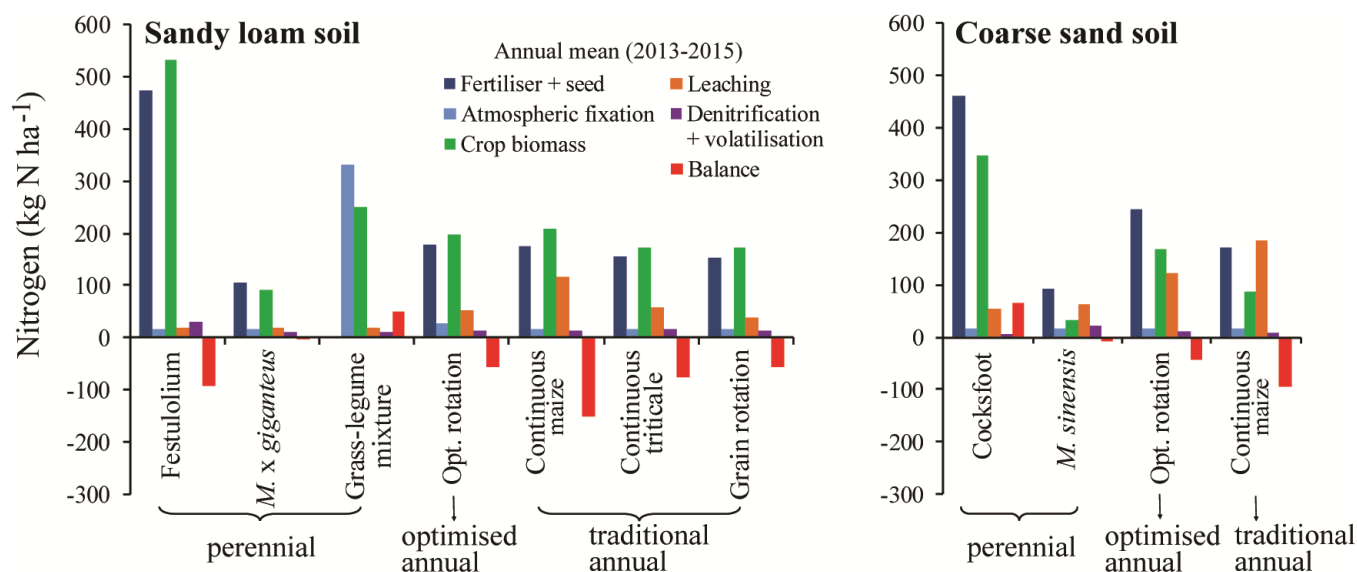

Figure 1. Nitrogen (N) inputs, outputs and balance for the studied systems in Denmark. Festulolium and cocksfoot are proxy for fertilised perennial grasses at their respective sites. Grass-legume mix on sandy loam soil is proxy for coarse sand soil. All fertiliser is mineral (N-P-K). Detailed description of all systems can be found in Manevski et al. (2017; 2018).

Table 1. Topsoil (0-20 cm) carbon (C) and nitrogen (N) amounts (mean, n=4, std. dev. in brackets) for selected study systems. Results are only for sandy loam soil site. Festulolium is a proxy for fertilised perennial grasses.

System	Crop	C/N		C (ton ha <sup>-1</sup> )		N (ton ha <sup>-1</sup> )	
		2012	2017	2012	2017	2012	2017
Perennial (novel)	Festulolium	12.3 (0.2)	12.4 (0.6)	43.7 (2.2)	44.8 (2.7)	3.6 (0.2)	3.6 (0.3)
	<i>Miscanthus x giganteus</i>	12.2 (0.4)	12.5 (0.5)	41.9 (2.0)	41.4 (3.8)	3.4 (0.3)	3.3 (0.3)
	Grass-legume mixture	12.5 (0.3)	12.1 (0.7)	40.0 (3.2)	43.5 (2.9)	3.2 (0.2)	3.6 (0.3)
Annual (novel)	Optimised rotation	12.0 (0.1)	11.7 (0.6)	42.9 (2.3)	40.3 (2.0)	3.6 (0.2)	3.5 (0.2)
Annual (traditional)	Continuous maize	12.7 (0.3)	12.0 (0.3)	43.3 (3.2)	40.8 (3.4)	3.4 (0.3)	3.4 (0.3)
	Continuous triticale	12.4 (0.5)	11.3 (0.7)	42.2 (3.3)	40.8 (2.6)	3.4 (0.4)	3.6 (0.3)
	Grain rotation	12.3 (0.6)	11.9 (0.5)	41.0 (2.7)	41.5 (2.7)	3.3 (0.3)	3.5 (0.3)

**Acknowledgements:** This study was funded by BioValue - Strategic Platform for Innovation and Research on value added products from biomass (<http://biovalue.dk>), which is co-funded by Innovation Fund Denmark.

## REFERENCES

- Manevski K., Lærke P.E., Olesen J.E., Jørgensen U., 2018. Nitrogen balances of innovative cropping systems for feedstock production to future biorefineries. *Sci. Total Environ.* 633, 372-390.
- Manevski K., Lærke P.E., Jiao X., Santhome S., Jørgensen U., 2017. Biomass productivity and radiation utilisation of innovative cropping systems for biorefinery. *Agric. For. Meteorol.* 233, 250-264.
- Parajuli R., Knudsen M.T., Birkved M., Djomo S.N., Corona A., Dalgaard T., 2017. Environmental impacts of producing bioethanol and biobased lactic acid from standalone and integrated biorefineries using a consequential and an attributional life cycle assessment approach. *Sci. Total Environ.* 598, 497-512.
- Solati Z., Manevski K., Jørgensen U., Labouriau R., Shahbazi S., Lærke P.E., 2018. Crude protein yield and theoretical extractable true protein of potential biorefinery feedstocks. *Ind Crops Prod.* 115, 214-226.

## MULTI-MODEL ASSESSMENT OF MITIGATION OPTIONS FOR GHG EMISSIONS IN CROPLANDS

CAROZZI, M.<sup>1</sup>, EHRHARDT, F.<sup>2</sup>, BRILLI, L.<sup>3</sup>, BELLOCCHI, G.<sup>4</sup>, BHATIA, A.<sup>5</sup>, DE ANTONI MIGLIORATI, M.<sup>6</sup>, DOLTRA, J.<sup>7</sup>, DORICH, C.<sup>8</sup>, DORO, L.<sup>9</sup>, FITTON, N.<sup>10</sup>, GRACE, P.<sup>6</sup>, GRANT, B.<sup>11</sup>, GIACOMINI, S.J.<sup>12</sup>, LÉONARD, J.<sup>13</sup>, LOUBET, B.<sup>14</sup>, MASSAD, R.S.<sup>14</sup>, MULA, L.<sup>9</sup>, PATTEY, E.<sup>11</sup>, SHARP, J.<sup>15</sup>, SMITH, P.<sup>10</sup>, SMITH, W.<sup>11</sup>, ZHANG, Q.<sup>16</sup>, RECOUS, S.<sup>17</sup>

<sup>1</sup>Agroscope, Zurich, Switzerland; <sup>2</sup>INRA, Paris, France; <sup>3</sup>University of Florence, Florence, Italy; <sup>4</sup>INRA, UREP, Clermont-Ferrand, France; <sup>5</sup>Indian Agricultural Research Institute, New Delhi, India; <sup>6</sup>Queensland University of Technology, Brisbane, Australia; <sup>7</sup>Cantabrian Agricultural Research and Training Centre, Muriedas, Spain; <sup>8</sup>Natural Resource Ecology Laboratory Colorado State University, Fort Collins, USA; <sup>9</sup>University of Sassari, Sassari, Italy; <sup>10</sup>University of Aberdeen, Aberdeen, UK; <sup>11</sup>Agriculture and Agri-Food Canada, Ottawa, Canada; <sup>12</sup>Universidade Federal de Santa Maria, Santa Maria,, Brazil; <sup>13</sup>INRA, AgrolImpact, Laon, France; <sup>14</sup>INRA, ECOSYS, Grignon, France; <sup>15</sup>Plant and Food Research, Auckland, New Zealand; <sup>16</sup>Chinese Academy of Sciences, Beijing, China; <sup>17</sup>INRA, FARE, Reims, France

### INTRODUCTION

The need to mitigate climate change requires the abatement of greenhouse gas (GHG) emissions and the sequestration of organic carbon (C) in cropland and grassland soils. Simulation models represent often the only possible way of extrapolating from current knowledge in both time and space, thus facilitating the construction and analysis of future scenarios. In this context, much attention is nowadays given to the assessment of uncertainties in modelling outcomes, considering that evidence provided by models can provide a solid basis for policy decisions. The IPCC revised guidelines for agricultural GHG emissions encourage the use of carefully calibrated and verified simulation models (Tier 3) to go beyond default values and country-specific emission factors (Tier 1 and Tier 2, respectively) to provide country scale estimates of emissions.

The JPI-FACCE funded CN-MIP project (C and N Models Inter-comparison and Improvement to assess management options for GHG mitigation in agrosystems worldwide), started in 2014, have the specific objective to evaluate, improve and compare the capacity of a variety of crop and grassland models (Brilli et al., 2017) to simulate the impact of combined agronomic practices in a set of cropland and grassland sites worldwide (Ehrhardt et al., 2018). Notwithstanding the mitigation options were well identified for these different systems, their degree of inclusion in the model applications is still limited, and there is a need to assess the uncertainty associated with the simultaneous simulation of production and emissions outputs. In this context, the specific objective of this work was to assess response of the ensemble of models, and associated uncertainty, for a set of management options for GHG attenuation in croplands situations, i.e., nitrogen (N) fertilisation regimes, irrigation amount and management of crop residues.

### MATERIAL AND METHODS

During a first step of the project (Ehrhardt et al., 2018), current biogeochemical models were assessed and calibrated through a blind test on five long-term field experiments with rotations of annual crops (including wheat, soybean, canola, maize, triticale, rice, oat) and assessing outputs as GHG emissions, C stocks and biomass production. Models calibration procedure consisted of five stages, gradually providing all the observed outputs to the modellers. The calibrated models were then used to evaluate the effect of mitigation options on GHG emissions and biomass production. A set of options with gradual intensities were tested with respect to site-specific N fertilisation regimes (from maximum to the minimum doses ordinarily used per crop), irrigation amounts (from +50 to -50% of the baseline values) and management of crop residues (exported or returned in the field), while keeping the parameter settings resulting from site-specific calibration. To do so, a simulation protocol provided to the modellers a set of maximum 60 scenarios per site, combining three strategies of management. The experimental data and simulated practices were applied to multiple years rotations from five sites (India, France, Australia, Canada and Brazil). A set of 13 process-based models contributed to the simulations: APSIM 7.6, Agro-C 1.0, CERES-EGC, DailyDayCent, DAYCENT (v4.5.2013, v4.5.2010, v4.5.2006), DNDC CAN, DSSAT GHG, EPIC 0810, FASSET v2.5, INFOCROP v2.1 and STICS v.831. Multi-model ensemble medians are used to interpret the individual responses and improve the accuracy of the assessment.

## RESULTS AND DISCUSSION

This overall assessment suggests that a reduction of N inputs toward minimum site/crop-specific requirements is able to significantly reduce GHG emissions while maintaining satisfying crop productivity. From the five sites N<sub>2</sub>O emissions can be mitigated up to 45% ( $\sim 0.3 \text{ kg N}_2\text{O-N ha}^{-1} \text{ y}^{-1}$ ) when the fertilisation is reduced to 80% from the site-specific maximum levels, while a reduction of 5% in the aboveground biomass production (AGB) is projected ( $\sim 0.6 \text{ t DM ha}^{-1} \text{ y}^{-1}$ ). Irrigation management produces site-specific effects on N<sub>2</sub>O emissions. High N doses combined with high irrigation volumes (up to +50% from the baseline) produces only a slight increase in N<sub>2</sub>O (+2-3%) accompanied by an equally increase in AGB. Reducing irrigation volumes down to -50% from the baseline and under low N doses causes a reduction of up to 60% in N<sub>2</sub>O emissions respect to the high N input, though there is an 18% reduction in AGB. No significant effects were observed from the crop residues management, whether exported or returned in the field, in combination with the other two production factors, N and water.

Although the response of the ensemble of models displays a degree of variability for each N dose (Figure 1), a proportional reduction of the N<sub>2</sub>O/AGB ratio is observed for each of the five sites with decreasing doses of N. This means that a reduction of N fertilisation is accompanied by more than a proportional decline in the emitted N<sub>2</sub>O with respect to the reduction of the biomass produced. This ratio highlights a contrasting variation of uncertainties among sites, with a strong dependency to N dose in some of them.

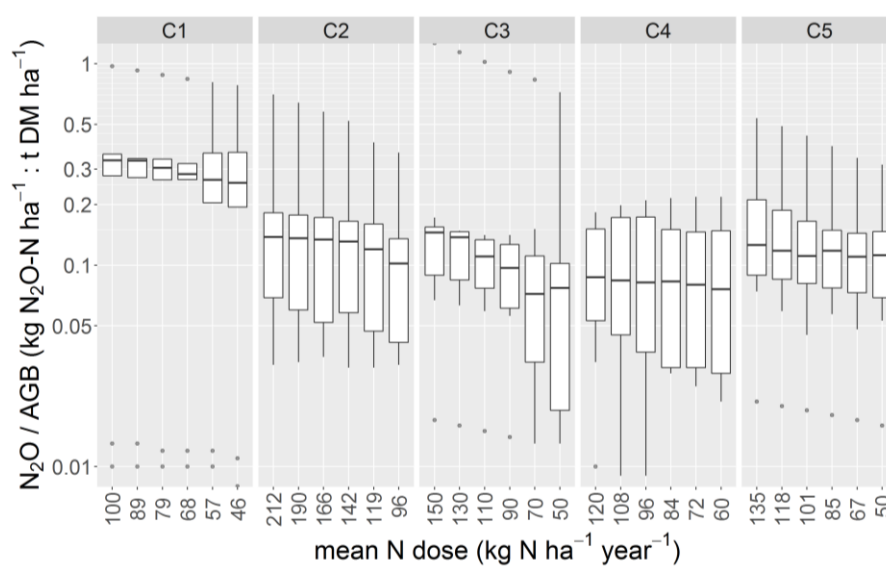

Figure 1. N<sub>2</sub>O to above ground biomass (AGB) ratio in the five contrasted pedoclimatic sites (C1 to C5) with N input reduction from maximum (left values on x axis) to minimum (right values). Boxplots report the response of the model ensemble. Black lines show multi-model median, boxes are 25<sup>th</sup> and 75<sup>th</sup> percentile, whiskers 10<sup>th</sup> and 90<sup>th</sup> percentile, circles indicate outliers.

## CONCLUSION

This work demonstrates the capability of using multi-model ensemble to quantify the impact of mitigation options on N<sub>2</sub>O emissions, such as reductions in fertiliser rates, and provides an estimate of uncertainties associated with the assessment.

## REFERENCES

- Brilli L., et al., 2107. Review and analysis of strengths and weaknesses of agro-ecosystem models in representing C and N fluxes. *Sci Total Environ.* 598, 445-470.
- Ehrhardt F., Soussana J-F., Bellocchi G., et al. 2018. Assessing uncertainties in crop and pasture ensemble model simulations of productivity and N<sub>2</sub>O emissions. *Glob. Change Biol.*; 24(2):e603–e616.

# 20<sup>th</sup> Nitrogen Workshop

## Coupling C-N-P-S cycles

June 25-27, 2018

Le Couvent des Jacobins, Rennes – France

### **Session IV: Studies and mitigation options at the farm level - Highlighted posters**

## FINETUNING ABATEMENT OF AMMONIA EMISSIONS FROM LIVESTOCK HOUSING ACCORDING TO IMPACT ON PROTECTED HABITATS

de Pue, D.<sup>1</sup>, Bral, A.<sup>1</sup>, Buysse, J.<sup>1</sup>

<sup>1</sup> Department of Agricultural Economics, Faculty of Bioscience Engineering, Ghent University, Belgium

### INTRODUCTION

94% of the ammonia (NH<sub>3</sub>) emission in Europe are caused by agricultural activities. Much of this ammonia pollutes nature areas through atmospheric dispersion, causing eutrophication and acidification of terrestrial ecosystems (Erisman *et al.*, 2013). This process poses a major threat to biodiversity and conservation goals in Natura 2000 sites, the EU conservation network aimed at assuring the long-term survival of Europe's most valuable species and habitats. In Flanders, this problem is controlled by a spatially differentiated licencing policy. A Significance Score is calculated for each new environmental permit application involving reactive nitrogen emissions. This score is a measure of the impact on the location where the damage caused by the new project is presumed to be highest. The Significance Score is based on the critical load of the protected habitats that are impacted by the emission source, with the critical load defined as a level of deposition below which no significant harmful effects on the environment are expected according to current knowledge (Ferm, 1998). Depending on the Significance Score, projects are subdivided in significance classes. Above 5%, authorization is only possible if an 'appropriate assessment' rules out significant deterioration of the protected sites. This type of policy is only partially effective, because the biggest share of ammonia deposition is attributable to sources with a Significance Score below 5% (Cools *et al.*, 2015). The Significance Score reflects the impact in the habitat that is most affected by the ammonia emissions. However, one could also choose for an indicator that aggregates the impact on all the habitats that are affected by the source. Such an Aggregate Deposition Score is a better reflection of the total damage caused by airborne ammonia emissions in nearby Natura 2000 sites (De Pue *et al.*, 2017). To reduce their contribution to critical deposition in protected habitats, farmers could apply ammonia-emission abatement techniques and measures. The goal of our research was twofold. Using an integrated policy assessment, we evaluated the efficiency and effectiveness of the current Flemish ammonia policy that is based on Significance Scores. Secondly, we modelled spatially optimal situations, whereby the mixed integer linear programming framework allowed to identify the optimal stable type and ammonia abatement measure depending on farm type, farm gross margin and, crucially, the location.

### MATERIAL AND METHODS

#### Data sources and processing

The simulations are performed on a dataset of all livestock facilities in Flanders, as provided to us by the Flemish Land Agency. The data consist of anonymous exploitation and stable numbers, maximally permitted animal numbers per stable and the animal housing systems for the year 2015. The location of the exploitations are only known up to the level of the municipality where the exploitation is located. For our spatially-explicit model, more precise location characteristics (X- and Y-coordinates) were needed. Therefore, for all municipalities in Flanders, we randomly assigned all exploitations within the municipality to pairs of coordinates from a map with all livestock facilities in that municipality. Next, for all these locations, the Significance Score and Aggregate Deposition Scores were calculated, with the methodology described by De Pue *et al.* (2017). Then, the exploitations were classified in different farm types, according to the animals present. Exploitations can consist of multiple farm types (eg Dairy and Pig Fattening), each of them modelled as independent units. All animals are characterized by an emission factor that depends on both the type of animals as the type of housing system and the presence of additional emission abatement measures. For the allocation of gross margins to all exploitations, we made use of accounting data provided to us by the Flemish Department of Agriculture and Fisheries. The data consist of farm type specific average gross margins for the years 2009-2015, along with their standard deviations. We use these data to acquire



a gross margin per farm type per exploitations, by sampling from a normal distribution. Yearly costs of stable types and abatement measures (operational costs and capital costs) were obtained from KWIN ([www.kwin.nl](http://www.kwin.nl)).

### Model description

We implemented a Mixed Integer Linear Programming (MIP) model in GAMS (General Algebraic Modeling System). The emission of a stable depends on the type of stable and the presence of additional abatement measures, two discrete variables in our model. In all models, the overall benefit is calculated by summing up the gross revenue for all farms, minus the cost of emission abatement for all farms. The overall ammonia emission is also calculated, as well as the total impact on protected habitats (the total Aggregate Deposition Scores) of all farms combined. Furthermore, no farm can have more animals than the maximum number of animals for which the farm has an environmental permit. We discern the following 5 scenario's in our model (Table 1). **FC (Full capacity)**: This scenario assumes the maximum number of animals allowed in every single farm, with every stable built according to the present stable type. In other words, we don't allow the model to choose low ammonia emission stables or other abatement measures. This scenario can be considered to be 'worst case'. **CP1 (Current Policy 1)**: In this scenario, the overall economic benefit is maximized, provided that no single exploitation can have a significance score higher than 5%. Just as in FC, we don't allow the model to choose new stable types. The model can only reduce animal numbers in order to comply with the 5% Significance Score rule. **CP2 (Current Policy 2)**: This scenario is the similar to Ref, with the only difference that in Sc1, the model can choose emission abatement techniques and low ammonia emission stables. **SO1 (Spatial Optimization 1)**: In this scenario, the overall impact is minimized, while constraining the result as such that the overall economic benefit should be the same as in CP2. There are no individual impact constraints imposed on the exploitations. **SO2 (Spatial Optimization 2)**: In this scenario, the overall benefit is maximized, while the overall impact cannot be higher than the impact obtained in CP2. Just as in SO1, no individual impact constraints are imposed.

Table 6: Scenario description

Name	Description
FC	Full Capacity, no stable choice or additional emission abatement
CP1	Current Policy (SS < 5%), no stable choice or additional emission abatement
CP2	Current Policy (SS < 5%), including stable choice and additional emission abatement
SO1	Spatially optimal, minimal impact with benefit in same range as CP2, no individual impact constraints. Rabbits, other poultry, ostriches and horses are fixed to maximum.
SO2	Spatially optimal, maximal benefit, impact similar as in CP2, no individual impact constraints. Rabbits, other poultry, ostriches and horses are fixed to maximum.

### RESULTS AND DISCUSSION

Overall results of the 5 model scenarios are displayed in table 2. The current policy of restricting the individual significance score to 5% (Ref) results in a decrease of total impact of 26.1% compared to FC, with a relatively modest decrease in total economic benefit (-5.4%). Allowing the switch to other stable types and the adoption of

emission abatement measures (CP1), the impact decreases with 2.3% compared to Ref, while the total benefit increases slightly (+1.0%). However, in the spatial optimal scenario of SO1, the impact decreases with 40.2% compared to CP2, with equal total benefit, highlighting room for improvement of the effectiveness of the spatially-differentiated policy (obtaining the best environmental quality at the same cost). The room for improving the efficiency (obtaining the same environmental quality at lower cost, or higher total benefit) is more limited: in SO2, the benefit increases with 3.4% compared to Sc1, with equal impact as in CP2.

Table 7: General results of model simulations

	FC	CP1	CP2	SO1	SO2
<b>Total NH<sub>3</sub> emission (kton/yr)</b>	35.7	33.3	32.7	24.1	31.1
<b>Total Impact (<math>\Sigma</math> ADS)</b>	28976	21416	20924	12510	20924
<b>Number of closed stables</b>  (max 44540)	0	698	644	4156	2121
<b>Number of closed exploitations</b>  (max 23408)	0	117	117	1710	918
<b>Total benefit (billion €)</b>	1.230	1.164	1.183	1.178	1.224

Figure 1 shows the choice of emission abatement technique for all exploitations with the farm type Pig Fattening, in the most strict scenario (SO1). The choice is plotted in function of income and impact quantiles (figure 1A) and mapped (figure 1B). Figure 1A only shows the stables that are operated at full capacity in scenario 2. Stables with a very high impact and a very low income (lower right corner) are missing from the plot, because these are either empty or operated below full capacity. For Pig Fattening stables, no stables stick to the low emission variant, because LAES-type V\_4\_6 has no additional cost compared to the non-LAES-type, while having a lower emission factor. The graph shows a clear pattern from left to right. The stables within the 75% lowest impact adopt stable type V\_4\_6 (Manure pits with water- and manure ditches, with curved pit walls and grid with elevated manure throughput). The stables with the 25% highest impact have to adopt an additional measure (PAS\_V, balance balls in the manure pit), while some of the farms even have to install chemical air scrubbers (S\_2). When we look at the distribution of emission abatement techniques on the map of Flanders, we see a clear difference between the West and the East of the region. In the west, with relatively few protected habitats, the model advises to adopt V\_4\_6 without additional measures, except for locations in the immediate vicinity of Natura 2000 sites. To the contrary, in the East, the model advises to adopt the additional PAS\_V measure next to stable type V\_4\_6. Similar patterns were obtained for other farm types (Dairy, Pig Rearing, Laying Hens, Broilers, etc.)

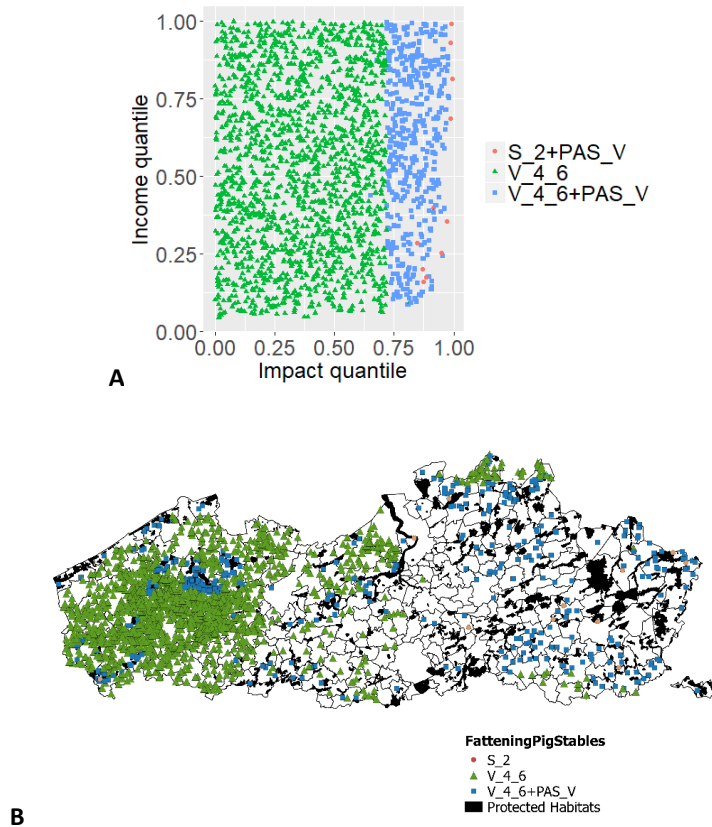

**Figure 1:** Choice of emission abatement technique for Fattening Pig Stables in Flanders, SO1. **(A):** Plotted in function of income quantile (based on gross margin) and impact quantile (based on Aggregate Deposition Score). **(B):** Plotted on the map of Flanders, showing the locations of protected habitats. V\_4\_6: Manure pits with water- and manure ditches, with curved pit walls and grid with elevated manure throughput. PAS\_V: Balance balls in the manure pit. S\_2: Chemical air scrubber.

## CONCLUSION

Our simulations indicate that there is substantial room for improvement in terms of environmental effectiveness of the Flemish ammonia policy, by reducing the overall impact on protected habitats without reducing the total economic benefit. Secondly, the MIP modelling framework allowed to identify the optimal stable types and ammonia abatement measures for all livestock exploitations in Flanders. Both conclusions help policy makers to improve the spatially-differentiated policy: the first by letting go or loosening the restriction by Significance Score, the second by differentiating advice and/or subsidies to farmers in the direction of the desired emission abatement techniques.

**Acknowledgements:** We would like to thank the Flemish Land Agency (VLM) and the Department of Agriculture and Fisheries for supplying us with data on livestock exploitations in Flanders.

## REFERENCES

- Cools, N. et al. (2015) Atmosferische stikstofdepositie en Natura 2000 instandhoudingsdoelstellingen in Vlaanderen . Verkennde gewestelijke ruimtelijke analyse van de ecologische impact , van sectorbijdragen en van de bijdrage. Brussel.
- Erismann, J. W. et al. (2013) 'Consequences of human modification of the global nitrogen cycle.', Philosophical

transactions of the Royal Society of London. Series B, Biological sciences, 368(1621), p. 20130116. doi: 10.1098/rstb.2013.0116.

Ferm, M. (1998) 'Atmospheric ammonia and ammonium transport in Europe and critical loads: A review', *Nutrient Cycling in Agroecosystems*, 51(1), pp. 5–17. doi: 10.1023/A:1009780030477.

De Pue, D. et al. (2017) 'Mapping impact indicators to link airborne ammonia emissions with nitrogen deposition in Natura 2000 sites', *Atmospheric Environment*. Elsevier Ltd, 166(X), pp. 120–129. doi: 10.1016/j.atmosenv.2017.07.020.

## NITRATE LEACHING RISK ASSESSMENT AFTER INCORPORATION OF FERTILIZED CATCH CROPS

DE WAELE, J.<sup>1</sup>, RADAM, E.D.<sup>2</sup>, DE VliegHER, A.<sup>3</sup>, VANDECASTEELE, B.<sup>3</sup>, DE NEVE, S.<sup>1</sup>

<sup>1</sup> Ghent University, Department of Environment, Belgium, <sup>2</sup> Philippine Rice Research Institute, Philippines, <sup>3</sup> Research Institute for Agriculture, Fisheries and Food (ILVO), Plant Sciences Unit, Belgium

### INTRODUCTION

Stimulating farmers to grow catch crops by increasing N input limits is one of the recurrent measures to reduce the contribution of agriculture to elevated nitrate concentrations in groundwater and surface waters. In some cases, farmers are even allowed to apply a limited N dose to the catch crops themselves, particularly after early harvested preceding crops such as winter cereals. This fertilization stimulates catch crop growth and therefore enhances the yield-related effects of growing catch crops. Uptake of fertilized N by the catch crop is assumed to prevent additional nitrate leaching during autumn and winter. After incorporation of the catch crop in spring, its easily decomposable N is mineralized and is expected to become available for the following crop. However, incorporation of catch crop biomass with a high C:N ratio may initially induce N immobilization, resulting in lower N availability for the following crop. Furthermore, remineralisation of immobilized N might be too late to be still taken up by the crop. For higher catch crop yields due to fertilization, the effect of N immobilization might be more pronounced. Our main research questions for this study were: (1) Are crop yields reduced after incorporation of catch crops with high C:N ratios? (2) Could fertilization of catch crops with high C:N ratios lead to additional nitrate leaching one year after application?

### MATERIAL AND METHODS

#### Incubation experiment

Aboveground biomass of white mustard (WM), Italian ryegrass (IR), black oat (BO) and a grass-clover mixture (GC) was collected on a field in Belgium in January 2012. Fresh yields were weighed and subsamples were taken to determine dry matter (DM) yield and C and N content. Subsamples were first dried at 60°C for 3 days. C and N content were then determined with a CN analyzer. Residual moisture content was determined by drying for 12 hours at 105°C in order to obtain DM yield. Catch crops were cut in small pieces of about 0.5 cm<sup>2</sup> and incorporated according to their yields in a sandy loam and a silt loam soil. The soil was brought at a bulk density of 1.4 g cm<sup>-3</sup> and maintained at a water filled pore space of 50%. Samples were incubated at 15°C for 98 days and every 2 weeks, some samples were destructed. Soil mineral N content (SMN) was determined with a continuous flow analyzer after extraction in a 1:5 soil:solution ratio with 1 M KCl. Microbial biomass carbon (MBC) was determined at day 0, 28 and 98 according to the chloroform fumigation method (Voroney et al., 1993).

#### Field experiment

Maize (*Zea mays*) was sown on a sandy loam soil in Belgium on May 1<sup>st</sup> 2013 and received a pig slurry fertilization of 133 kg total N ha<sup>-1</sup> topped up with 30 kg N ha<sup>-1</sup> of NH<sub>4</sub>NO<sub>3</sub>. The strip-plot experimental design with four replications consisted of two catch crop species incorporated to the soil in early spring: WM and BO, which had both demonstrated N immobilization in the incubation experiment. These catch crops were sown after winter barley on two different dates: August 1<sup>st</sup> and 30<sup>th</sup> 2012. Catch crops had received a pig slurry application at sowing at rates of 57 and 114 kg total N ha<sup>-1</sup>. Fallow treatments and non-fertilized catch crops were included. DM yield and C and N content of aboveground parts of WM and BO were determined as described for the incubation. Maize development was assessed 64 days after sowing by measuring maize plant height and the number of fully developed leaves for ten randomly chosen plants per plot. Fully developed leaves were determined according to the leaf collar method (Abendroth et al., 2011). The plant height was measured from the base up to where the last fully developed leaf was connected to the stem. Maize grain yield was determined 300 days after sowing by harvesting 4 randomly chosen rows per plot, corresponding to an area of 4.5 m<sup>2</sup>. Maize grain yield was only

determined on plots incorporated with early sown catch crops and on fallow plots. Soil samples were taken before catch crop incorporation in April, in July, in September and in November at 0-30, 30-60 and 60-90 cm and analyzed for SMN. Microbial biomass carbon (MBC) was determined on the 0-30 cm soil samples in September. Both SMN and MBC were determined as described for the incubation.

## RESULTS AND DISCUSSION

### Incubation experiment

The relative amount of N mineralized after 3 months was in the order  $GC > IR > WM > BO$  and was negatively correlated with the C:N ratio of the catch crops (respectively 17, 20, 34 and 40). N mineralization was for each catch crop higher on sandy loam than on silt loam. N immobilization was prominent and long lasting for BO, which was supported by a significantly higher MBC than for the bare soil treatment throughout the incubation period.

### Field experiment

C:N ratio of catch crops in spring 2013 differed from the incubated samples collected in 2012: it was 33 to 42 for WM and 17 to 20 for BO, indicating that N immobilization under maize would probably be more prominent on plots incorporated with WM than on plots incorporated with BO.

Before incorporation in April, SMN over the total sampling depth was significantly higher on plots under WM and BO than on fallow plots and it was positively correlated with fertilization. These effects on SMN were clearly observed at all depths under late sown catch crops, while under early sown catch crops, they were only prominent in the 60-90 cm layer. Total SMN was each time higher under late sown catch crops than under early sown catch crops.

In July, no significant differences were observed in SMN. The number of maize leaves ranged from 5 to 6 and was equal for all treatments. However, maize plants were significantly taller on plots incorporated with BO (13.7 cm) compared to plots incorporated with WM (12.4 cm) and fallow plots (12.5 cm), confirming that N immobilization may have been stronger on plots incorporated with WM. There was no effect of catch crop fertilization or sowing date.

In September, total SMN was equal for all treatments. Only in the 60-90 cm layer we did observe a significantly higher SMN on fallow plots than on plots incorporated with catch crops, while on fallow plots SMN was also positively correlated with fertilization. At the onset of autumn, this indicates a higher nitrate leaching potential on fallow plots. MBC in the 0-30 cm layer was significantly higher on plots incorporated with WM (59 mg kg<sup>-1</sup> dry soil) and BO (56 mg kg<sup>-1</sup> dry soil) than on fallow plots (51 mg kg<sup>-1</sup> dry soil), but only for late sown catch crops. Maize development was not assessed in September.

In November, no significant differences were observed in SMN. Maize grain yields were only significantly different between plots incorporated with fertilized BO (10.2 Mg DM ha<sup>-1</sup>) and fallow plots that had received the highest fertilization dose (11.5 Mg DM ha<sup>-1</sup>). This result was contradicting with the results for plant height in July.

## CONCLUSION

An incubation experiment demonstrated N immobilization for WM and BO incorporated in soil, but this was less clear in the field. Compared to fallow soil, incorporation of BO had a beneficial effect on the maize plant height in early summer, even though this was not reflected in the final yield. As incorporation of BO and WM resulted only in a small increase in MBC (5-8 mg C kg<sup>-1</sup> dry soil) in the late summer, and not in a consistent reduction in final maize grain yields, we believe N immobilization did not last long enough to limit N uptake by the maize. It is therefore unlikely that additional nitrate leaching would occur in autumn due to incorporation of fertilized catch crops, under the condition that spring fertilization of the main crop is reduced for the expected N release from

the catch crop. Growing catch crops seemed furthermore promising in reducing the risk of nitrate leaching even one year after sowing them.

#### **REFERENCES**

- Abendroth, L.J., Elmore, R.W., Boyer, M.J. and Marlay, S.K., 2011. Corn Growth and Development. PMR 1009. Iowa State University Extension, Ames, pp. 760-788.
- Voroney, R.P., Winter, J.P., Beyaert, R.P., 1993. Soil microbial biomass C and N, in: Carter, M.R. (Ed.), Soil Sampling and Methods of Analysis. Lewis, Boca Raton, pp. 277-286.

## NITROUS OXIDE-NITROGEN EMISSION FACTORS FOR A BIOFUEL CROP

CANTARELLA, H.<sup>1</sup>, CARVALHO, B.G.O.<sup>1</sup>, LOURENÇO, K.<sup>1</sup>, CARVALHO, J.L.N.<sup>2</sup>, GONZAGA, L.C.<sup>1</sup>, KURAMAE, E.<sup>3</sup>, SOARES, J.R.<sup>4</sup>; CARMO, J.B.<sup>5</sup>

<sup>1</sup> Agronomic Institute of Campinas, Brazil; <sup>2</sup> Bioethanol Sci. and Tech. Laboratory, Brazil; <sup>3</sup> Netherlands Institute of Ecology, the Netherlands; <sup>4</sup> University of Campinas, Brazil; <sup>5</sup> São Carlos Federal University, Brazil

### INTRODUCTION

Ethanol sustainability indicators are important, as this fuel replaces other fuels of fossil origin. Nitrogen fertilizers account for more than 20% of the energy spent to produce sugarcane in the field (Boddey et al., 2008) and for about 40% of the greenhouse gases (GHG), mostly as nitrous oxide (N<sub>2</sub>O), emitted to produce ethanol (Lisboa et al., 2011), depending on the N<sub>2</sub>O-N emission factor considered. Approximately 10 Mha of sugarcane is grown in Brazil, half of which is used for ethanol production, which comprises 40% of the fuel used in light vehicles in that country. However, very little published information was available on GHGs emission for sugarcane cultivation in that country, which is the largest producer of sugarcane and ethanol from sugarcane in the world. The objective of this study was to obtain solid estimates of N<sub>2</sub>O emission for Brazilian sugarcane production, of interest for calculations of the GHGs balance of ethanol.

### MATERIAL AND METHODS

A survey of the international literature was used to gather information on N<sub>2</sub>O emission from N fertilizer and from important by-products of the sugarcane and ethanol production, recycled in the field as part of the fertilization of this crop. In addition, we added data from recent research, still unpublished, produced by our group, to draw a map as complete as possible of emissions associated with sugarcane production under field conditions in Brazil. We collected data from experiments in which mineral N fertilizers were applied to a variety of fields representative of the most relevant growing areas. In addition, we obtained data about N<sub>2</sub>O emission factors of by-products such as filter cake, the residue of sugarcane filtration, and vinasse, the residue of ethanol distillation. The former is applied at rates between 5 and 40 t ha<sup>-1</sup> and the latter, between 50 and 100 m<sup>3</sup> ha<sup>-1</sup>.

### RESULTS AND DISCUSSION

The N<sub>2</sub>O EF found in most field experiments (mean value 0.52%) were below the 1% value, used as default value by the IPCC (Table 1) and far below the figures reported in studies conducted in other regions of the world (Lisboa et al., 2011). These low EF values are usually credited to the good drainage properties of the deep Oxisols, where sugarcane is commonly cultivated in Brazil. The low N<sub>2</sub>O emissions were found in different soil types, management conditions, and N sources. Emissions are lower with ammonium nitrate (NA) than with urea (UR) (Table 1). A very low EF was found for calcium nitrate; the authors attributed that to the prevalence of nitrification over denitrification as the main cause of N<sub>2</sub>O emission in that study (Soares et al., 2016). There is few information about N<sub>2</sub>O EF for sugarcane residues in the literature and the data available is all from recent publications. The results of our survey were highly variable but, in general, the values were relatively low, except for vinasse (EF 1.72%) (Table 2). However, the rates of N applied as vinasse are usually below 50 to 60 kg N ha<sup>-1</sup>.

### CONCLUSION

The relatively low N<sub>2</sub>O EF values for sugarcane found in a wide variety of field experiments contribute to decrease the GHGs emissions when ethanol replaces fossil fuels.



Table 1. Data from experiments in Brazil for N<sub>2</sub>O emission factors (EF) of different N sources applied to sugarcane. SA: ammonium sulphate; NA: ammonium nitrate; UR: urea, CAN: calcium ammonium nitrate.

Source	N <sub>2</sub> O-N EF (% of N)	Observation	Reference
SA	0.27 – 0.36	Clay soil	Vargas et al. (2014)
NA	0.55 – 0.74	Clay soil	Vargas et al. (2014)
SA	0.07 – 0.10	Medium textured	Vargas et al. (2014)
NA	0.19 – 0.25	Medium textured	Vargas et al. (2014)
UR	0.69; 0.75, 1.68	Bare soil, ratoon	Soares et al. (2015; 2016)
Calcium nitrate	0.04	Bare soil, ratoon	Soares et al. (2016)
UR	1.11	Plant cane cycle	Carmo et al. (2013)
NA	0.68 – 0.96 (x = 0.80)	Ratoon, straw	Carmo et al. (2013)
NA	0,21	Bare soil	Pitombo et al. (2016)
NA	1,06	Straw	Pitombo et al (2016)
NA	0.07 – 0.12 (x=0.10)	Wet season; straw	Lourenço et al (submitted)
NA	0.51	Dry season, straw	Lourenço et al (submitted)
UR	0.3 – 2.3 (x = 1.1)	Plant	Soares et al (submitted)
CAN	0.1 – 0.7 (x = 0.4)	Plant	Soares et al (submitted)
UR	0.9 – 1.4 (x = 1.1)	Ratoon, straw	Soares et al (submitted)
CAN	0.1 – 0.7 (x = 0.4)	Ratoon, straw	Soares et al. (submitted)
NA	0.24 – 0.44 (x = 0.34)	80 and 120 kg/ha	Siqueira Neto et al (2015)
UR	0.52 – 0.83 (x = 0.68)	80 and 120 kg/ha	Siqueira Neto et al (2015)
UR	0.20	Ratoon, straw	Paredes et al. (2014)
SA	0.58	Ratoon, straw	Paredes et al. (2015)
NA	0.05 – 0.16	Straw	Silva et al. (2017)
AS	0.14 – 0.81 (x= 0.50)	Dry season, straw	Gonzaga et al (submitted)
AS	0.12 – 1.44 (x = 0.75)	Wet season, straw	Gonzaga et al (submitted)
<b>N = 23</b>	<b>X = 0.52</b>		

Table 2. N<sub>2</sub>O emission factor of by-products of sugar and ethanol production, applied to sugarcane fields.

By-product	N <sub>2</sub> O-N EF (% of applied N)	Reference
Filter cake	0.10 – 0.17 (0.13)	Siqueira Neto et al (2015)
Vinasse	1.86 – 2,75	Pitombo et al (2016)
	0,01 – 0,79 (0,30)	Lourenço et al. (submitted)
	0.86 – 1.84 (1.35) Dry season	Lourenço et al. (submitted)
	1.15 – 4.59	Silva et al. (2017)
	1.04-2.20	Paredes et al. (2015)
	2.50	Paredes et al. (2014)
	0.54 – 0.77 (0.65)	Siqueira Neto et al. (2015)
	0.44 – 0.78 (0.56)	Oliveira et al. (2013)
	<b>X = 1,72</b>	
Concentrated vinasse	0.18 – 0.34 (0.27) Wet season	Lourenço et al. (submitted)
	0.43 – 0.56 (0.50) Dry season	Lourenço et al. (submitted)
	1.36 – 1.68	Pitombo et al. (2016)
	<b>X = 0,95</b>	

## REFERENCES

- Boddey, R. M., Soares, L. H. B., Alves, B. J. R., and Urquiaga, S. (2008). Bio-ethanol production in Brazil. In "Renewable Energy Systems: Environmental and Energetic Issues" (D. Pimentel, ed.), pp. 321-356. Springer, New York.
- Lisboa, C. C., Butterbach-Bahl, K., Mauder, M., and Kiese, R. (2011). Bioethanol production from sugarcane and emissions of greenhouse gases - known and unknowns. *Global Change Biology Bioenergy* **3**, 277-292.
- Soares, J. R., Cassman, N. A., Kielak, A. M., Pijl, A., Carmo, J. B., Lourenço, K. S., Laanbroek, H. J., Cantarella, H., and Kuramae, E. E. (2016). Nitrous oxide emission related to ammonia-oxidizing bacteria and mitigation options from N fertilization in a tropical soil. *Scientific Reports* **6**, 30349.

**ILLUSTRATIVE MODELLING OF NITRATE LEACHING FROM FERTILISER AND MANURE NITROGEN APPLICATIONS**

HUTCHINGS, N.J.<sup>1</sup>, SØRENSEN, P.<sup>1</sup>

<sup>1</sup> Dept of Agroecology, Aarhus University, Denmark

**INTRODUCTION**

Fertiliser and manure can contribute to nitrate leaching (Cameron et al., 2013) but whereas all fertiliser nitrogen (N) is immediately available to crops, the manure organic N must first be mineralised. If this occurs outside the growing season, this can increase nitrate leaching. Here we use a simple model to illustrate the main processes and how they contribute to differences between nitrate leaching from fertiliser, manure and digestate.

**MATERIAL AND METHODS**

The soil model contains three types of organic matter (OM); crop residues, manure OM and humus. The OM is described in terms of C and N (Fig 1). The OM from crop residues is easily degradable ( $E_{crop}$ ; kg) whereas that in manure is partitioned between easily degradable ( $E_{man}$ ; kg) and the more resistant humus ( $H$ ; kg). Easily degradable OM in crop residues and manure decay at different rates ( $k_{C1}$  and  $k_{C2}$  year<sup>-1</sup>, respectively). However, the same proportion ( $h$ ) of the C in both types of OM is converted to humic OM, when easily degradable OM is decomposed. The C:N of the humic OM ( $C_{nHUM}$ ) is constant, so a given amount of humic C will always bind the same amount of N. The N in degraded OM not bound in the new humic material is mineralised and added to the mineral N ( $Min_N$ ; kg). The humic OM will itself be decomposed, albeit at a much slower rate ( $k_{C3}$ ; year<sup>-1</sup>), and all associated N is mineralised.

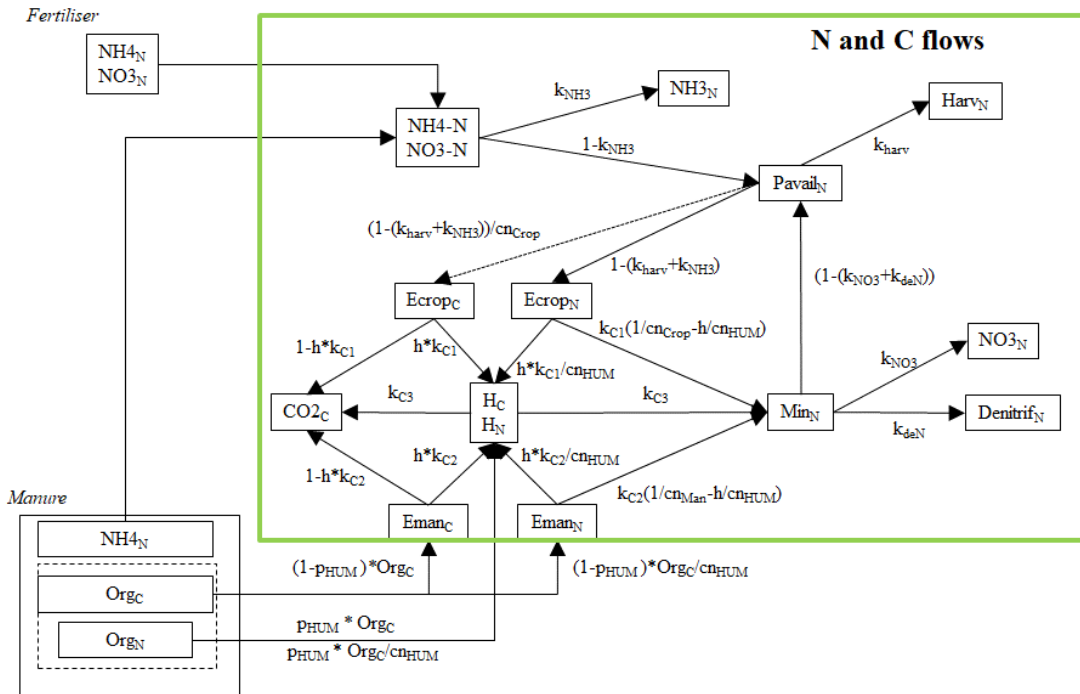

Figure 1 Schematic of the C and N flows in the model

A proportion ( $k_{NH_3}$ ) of the mineral N input in fertiliser or manure is lost as  $NH_3$  and the remainder is considered plant available ( $P_{avail-N}$ ; kg). A proportion ( $k_{harv}$ ) of  $P_{avail-N}$  is removed by harvesting and the remainder is partitioned to crop residues ( $E_{crop-N}$ ; kg). The associated addition of C to the crop residue C ( $E_{crop-C}$ ; kg) is calculated using an assumed C:N ratio ( $C_{nCrop}$ ). A proportion ( $p_{HUM}$ ) of the C in the manure organic matter is added directly to the humic C ( $H_C$ ; kg). The remaining manure C is added to the easily degradable manure C ( $E_{man-C}$ ; kg). Since the C:N ratio of the

humic material is constant, the manure organic N added to the humic N ( $H_N$ ; kg) can be calculated. The remainder is partitioned to the easily degraded manure N ( $E_{\text{manN}}$ ; kg). The N mineralised is partitioned between nitrate leaching ( $k_{\text{NO}_3}$ ), denitrification ( $k_{\text{deN}}$ ) and plant available N ( $1 - (k_{\text{NO}_3} + k_{\text{deN}})$ ). The flows are calculated for two periods in the year; in and outside the growing season. In the simulations here,  $100 \text{ kg ha}^{-1}$  of fertiliser or cattle slurry N was applied at the start of the first year. Gaseous N emissions were set to zero. The model was run for 10 years, with harvested N set at 65% of plant-available N in each year. The mineral and organic N still in the soil after 10 years was assumed to be partitioned between harvested material and nitrate leaching in the same proportions as that found in the 10<sup>th</sup> year.

## RESULTS AND DISCUSSION

The dynamics of the soil OM N pools are shown in Fig 2a. During the year of application, all fertilizer N that enters the soil is incorporated into plant material. Some is harvested and the crop residues are largely decomposed, with the organic N either mineralized or converted into humus N. Some of this N is leached during the first winter and the remainder incorporated into plant material the next season. This is repeated in subsequent years, with the remaining N from the fertilizer mainly being immobilized in humic OM, where it slowly decomposes and is gradually depleted by harvesting and leaching (Fig 2b). When N is applied as manure or digestate, the mineral N

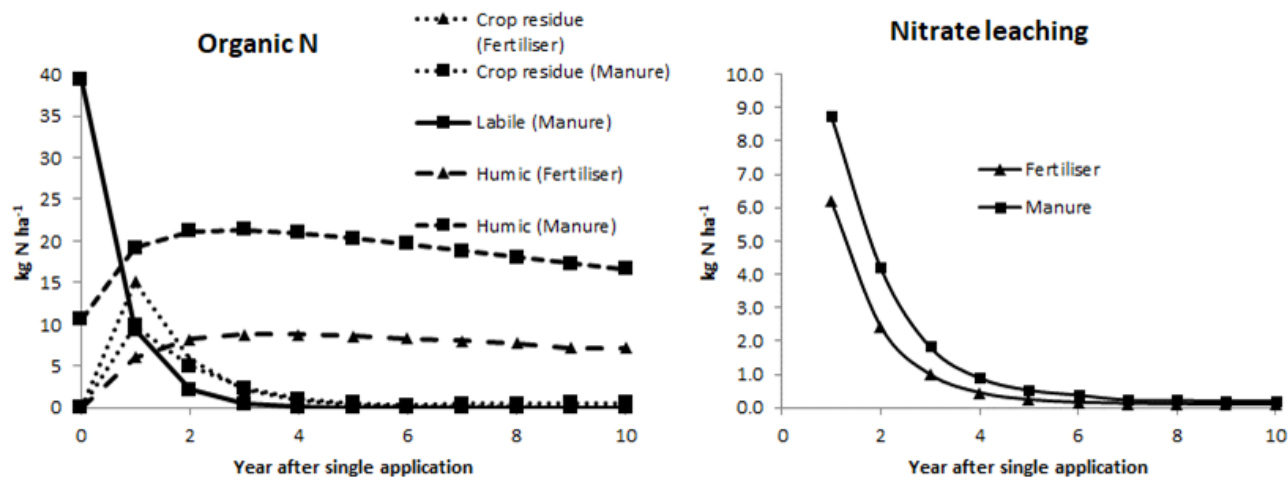

Figure 2 The organic N and nitrate leaching dynamics from the same total N added as fertilizer or manure

component behaves as fertilizer N. Most manure OM N enters the labile pool and the rest enters the humic pool. More labile and humic OM is present over winter than when fertilizer is the N source, fueling higher nitrate leaching. , Over a 15 year period, 83 and 67% of the N applied in fertilizer and manure was harvested respectively, while 11 and 19% respectively was leached.

## CONCLUSION

This model allows the N dynamics following the application of various N sources to be followed over time. Despite its conceptual simplicity, it appears capable of simulating the major processes fairly realistically.

**Acknowledgements:** This work was supported by the Strategic Research Alliance DNMARK ([www.dnmark.org](http://www.dnmark.org)).

## REFERENCES

Cameron, K.C., Di, H.J., Moir, J.L., 2013. Nitrogen losses from the soil/plant system: a review. *Annals of Applied Biology* 162(2), 145-173.

## NITROGEN SUPPLY BY ROLLER-CRIMPED AGRO-ECOLOGICAL SERVICE CROPS IN ORGANIC CABBAGE PRODUCTION

HEFNER, M.<sup>1</sup>, KRISTENSEN, H.L.<sup>1</sup>

<sup>1</sup> Department of Food Science, Aarhus University, Denmark

### INTRODUCTION

Agro-ecological service crops (ASC), also known as green manure, catch or cover crops, are widely used in organic agriculture. However, challenges exist in accounting for the nitrogen (N) supply from the ASC to the cash crop, as the amount of N supply depends on the species employed. Legumes have a low C/N ratio and decompose faster than cereals, whereas cereals are better in scavenging soil N than legumes. Growing a mixture of legume/cereal has therefore been proposed as the best strategy (Fageria et al., 2005). Interest in reduced tillage techniques is rising and roller-crimping the ASC provides an alternative to the traditional incorporation of the ASC as green manure. However, N shortage due to plant-soil interactions can pose a challenge in the N management of this reduced tillage system.

### MATERIAL AND METHODS

A field experiment was conducted at the Research Centre Årsløv, Denmark (10°27'E, 55°18'N) on a sandy loam (Typic Agrudalf) from October 2016 until November 2017. The experiment was a complete block design with two treatment factors, which were (1) the ASC species and (2) the termination method of the ASCs. The 6 ASC species tested were (1) winter fababean (*Vicia faba* L.), (2) winter pea (*Pisum sativum* L.), (3) winter vetch (*Vicia sativa* L.), a 50/50 mixture of (4) winter rye (*Secale cereal* L.) and winter fababean, (5) winter rye and winter pea and (6) winter rye and winter vetch. The ASC termination treatments were (1) full incorporation by tillage of the ASC as green manure and (2) roller-crimping of the ASC. Tilled bare soil served as the control. The ASC was sown on October 9<sup>th</sup>, 2016 and terminated on May 30<sup>th</sup>, 2017. White cabbage (*Brassica oleracea* L. cv. Coronet) was transplanted on June 21<sup>st</sup> and harvested on November 3<sup>rd</sup>. Measurements were conducted on ASC and cabbage biomass and N content, and soil mineral N to 2.5 m depth.

### RESULTS AND DISCUSSION

The termination of ASC by full incorporation or roller-crimping did not affect the N uptake of cabbage (data not shown), indicating that N supply for the cabbage was equal for both termination strategies, even though the N released from ASC residues left on the soil surface and from soil N mineralization was expected to be lower in the roller-crimped treatment. The three ASCs of legume/rye mixtures and the pure pea showed the highest ASC N uptake in the spring (Figure 1), whereas N uptake was lower for fababean and lowest for vetch. The low N uptake of vetch was caused by a very low biomass of vetch (data not shown), due to poor overwintering. The soil mineral N content in 0 to 2.5 m depth was highest in the bare soil, followed by the pure legume ASCs of fababean, pea and vetch and it was lowest in the legume/rye ASCs (Table 1). The low soil mineral N content correlated with a higher plant N uptake of the legume/rye ASCs (Figure 1). The N uptake of cabbage at harvest (Figure 1) followed a similar pattern as the soil mineral N in the spring (Table 1), where lowest values were obtained in the treatments with legume/rye ASCs and highest values in the pure legume ASCs and the bare soil control. The low N uptake of cabbage after the legume/rye ASCs may be a result of slower N release from the legume/rye residues left on the soil surface and pre-emptive competition, as rye took up mineral N, which was subsequently not available for the cabbage (Thorup-Kristensen et al., 2003).

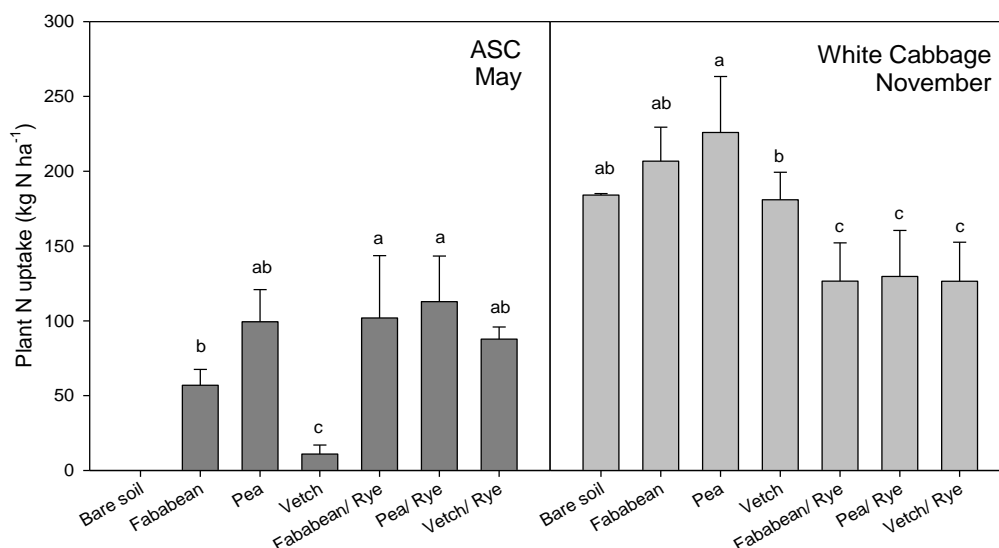

Figure 1. Plant N uptake ( $\text{kg N ha}^{-1}$ ) by the ASCs at termination (24. May 2017) and white cabbage at harvest (3. November 2017). Bars represent standard deviations,  $n=3$ . Different letters indicate significant differences at  $p<0.05$ .

Table 1. Soil mineral N ( $\text{kg ha}^{-1}$ ) at planting of cabbage (June 13<sup>th</sup>, 2017). Standard deviations are shown,  $n=3$ . Different letters indicate significant differences between ASC species at  $p<0.05$ .

Soil depth (m)	Bare soil	Bean	Pea	Vetch	Bean/ Rye	Pea/ Rye	Vetch/ Rye
0-0.25	45±5.5 <sup>a</sup>	25.7±3.6 <sup>b</sup>	23.5±2.9 <sup>bc</sup>	15.4±5.3 <sup>d</sup>	15.7±5.5 <sup>cd</sup>	15.7±3.4 <sup>cd</sup>	14.2±2.4 <sup>d</sup>
0.25-0.5	38±5.1 <sup>a</sup>	12±2.7 <sup>bc</sup>	18.7±10.2 <sup>b</sup>	10.8±4.8 <sup>bc</sup>	4.1±2.4 <sup>c</sup>	8.2±5.1 <sup>c</sup>	4.2±1.2 <sup>c</sup>
0.5-1	76.7±17.9 <sup>a</sup>	50.2±18.7 <sup>b</sup>	58.2±9.4 <sup>ab</sup>	45.1±14.8 <sup>b</sup>	15.3±4.2 <sup>c</sup>	11±5.9 <sup>c</sup>	8.3±3.3 <sup>c</sup>
1-1.5	72.1±2.9 <sup>ab</sup>	76.7±27.1 <sup>a</sup>	63.3±7 <sup>abc</sup>	70.9±20.7 <sup>ab</sup>	34.3±2 <sup>cd</sup>	24.2±13.9 <sup>d</sup>	38.6±28 <sup>bd</sup>
1.5-2	53.7±5.9 <sup>a</sup>	38.6±5.4 <sup>ac</sup>	46.8±10.7 <sup>ab</sup>	39.6±10.9 <sup>ac</sup>	40.9±16.5 <sup>ac</sup>	24.4±6.6 <sup>c</sup>	30.6±13.6 <sup>cd</sup>
2-2.5	40.2±8.2 <sup>a</sup>	19.2±6.8 <sup>bc</sup>	29.6±13.6 <sup>ab</sup>	18.2±4.1 <sup>bc</sup>	21.9±2.9 <sup>bc</sup>	16.3±4.9 <sup>bc</sup>	12.7±4.3 <sup>c</sup>

## CONCLUSION

The N uptake of white cabbage was not affected by ASC termination, indicating that roller-crimping did not hamper N supply. The legume/rye ASCs took up more soil mineral N during growth and resulted in lower N uptake by cabbage compared to pure legume ASCs. The highest cabbage N uptake was obtained following pea and fababean ASCs and in the bare soil control, showing the potential of roller-crimping of ASC as a reduced tillage system for production of organic cabbage.

**Acknowledgements:** The project was funded by the ERA-net CORE Organic PLUS, the Green Growth and Development programme (GUDP) under the Danish Ministry of Environment and Food and Aarhus University as part of the project SOILVEG.

## REFERENCES

- Fageria, N. K., Baligar, V. C., and Bailey, B. A. 2005. Role of cover crops in improving soil and row crop productivity. *Communications in Soil Science and Plant Analysis* 36, 2733-2757.
- Thorup-Kristensen, K., Magid, J., and Jensen, L. S. 2003. Catch crops and green manures as biological tools in nitrogen management in temperate zones. 79, 227-302.

## **ACIDIFICATION PRIOR TO DRYING OF DIGESTATE SOLIDS AS A BIO-BASED FERTILISER AFFECTS NITROGEN AND PHOSPHORUS UPTAKE AND FERTILISER VALUE WHEN APPLIED TO MAIZE**

LIU, JN.<sup>1</sup>, MÜLLER-STÖVER, DS.<sup>1</sup>, JENSEN, LS.<sup>1</sup>

<sup>1</sup> University of Copenhagen, Department of Plant and Environmental Science, Plant and Soil Science, Denmark

### **INTRODUCTION**

As one of the most efficient treatment technologies of biodegradable waste, anaerobic digestion could simultaneously achieve environmental pollution control and energy recovery. The process produces biogas (60–70% CH<sub>4</sub>), but also a digestate requiring further disposal, like land application or liquid-solid separation and drying of the solid fraction into a stabilized organic fertilizer product. Among waste management technologies, thermal drying is an attractive option since it's a highly effective way to reduce digestate volume/ weight by evaporating moisture and facilitate the sanitation, storage and transportation of the end product (Pantelopoulos et al., 2016). However, relative high N losses via NH<sub>3</sub> volatilization will occur during the thermal drying process, which reduces the agronomic value of the processed waste as a fertilizer and contributes to eutrophication and acidification of ecosystems. Acidification before thermal drying of digestate solids can largely mitigate NH<sub>3</sub> emissions and therefore increase the N fertilizer value of the final dried product. Concentrated H<sub>2</sub>SO<sub>4</sub> is commonly used in Denmark to acidify slurry and also documented to minimise N losses significantly during thermal drying of digestate solids (Pantelopoulos et al., 2016; Liu et al., unpublished). Acidification can also be achieved by using aluminium sulphate through hydrolysing to the aluminium hydroxide precipitate and dilute sulfuric acid solution (Rogueiro et al., 2016). Using aluminium sulphate as acidifier has also been shown to significantly reduce NH<sub>3</sub> emissions from digestate solids during the drying process (Liu et al., unpublished)

However, while the N and P fertilizing effect of the liquid fraction of digestate is well documented by previous studies, the behaviour of thermally treated digestate solids in soil and their potential for mineral N and P fertilizer substitution in crop production is so far rarely reported. There are indications that the mineralization rate of the organic nitrogen in dried products could increase (Smith and Durham, 2002) or decrease (Case et al., 2016) on account of drying induced conditioning of the organic matter. Furthermore using aluminium sulphate as acidifier has the risk of reducing P plant availability in the products by the formation of insoluble aluminium phosphate compounds (Smith and Moore, 2001).

Thus, the overall objective of this study was to evaluate the yield response and N and P uptake of maize when fertilized with digestate solids (DS) treated by drying and acidification (using concentrated sulfuric acid or aluminium sulphate as acidifier). It was hypothesized that:

- 1) Acidification using aluminium sulphate and concentrated sulfuric acid will result in higher retention of NH<sub>4</sub><sup>+</sup> in dried digestate solids and therefore lead to higher N uptake at the beginning, but the reduced organic N mineralisation will lead to a lower subsequent N uptake rate compared to non-acidified dried products
- 2) Drying and aluminium sulphate used as acidifier will result in a lower soluble fraction of P in the thermally dried products, leading to a lower P uptake of the plant after soil application, compared with applying the untreated digestate solids

### **MATERIAL AND METHODS**

#### **Sampling and treatment of solids producing**

Biogas-digestate solids (DS), i.e. the fiber fraction from mechanically (decanter centrifuge) separated biogas plant effluents, were collected freshly from Morsø biogas plant, Denmark. The input to the biogas plant includes mainly cow (70%) but also pig (20%) and chicken manure (8-9%), with some food waste (1-2%) as co-substrate. Additionally, anaerobically digested sewage sludge solids (SS) were sampled from Bjerghmarken WWTP, Roskilde, Denmark. The WWTP process includes biologic and chemical precipitation of P (incl. some  $\text{AlCl}_3$  and  $\text{Al}_2(\text{SO}_4)_3$ ). The secondary sludge is passed to a thermophilic biogas digester and processed with 15 d hydraulic retention time (HRT). Effluent is treated with flocculants (polymers) and dewatered in a screw decanting centrifuge. After collection, DS and SS were stored at  $-20^\circ\text{C}$  until further use. Acidification of DS/SS was performed prior to drying by placing 50 g (w.w) DS/SS in a glass beaker (500 ml) and gradually applying  $\text{Al}_2(\text{SO}_4)_3$  powder directly or concentrated sulfuric acid, followed by continuous stirring until acid evenly distributed on all surfaces of the solids. Based on earlier trials to maximize ammonium retention, a final pH of 7.5 (DS) or 8.0 (SS) with  $\text{Al}_2(\text{SO}_4)_3$  powder, 6.5 (DS) or 7.5 (SS) with concentrated sulfuric acid was targeted. Acidification with  $\text{Al}_2(\text{SO}_4)_3$  was done 24 h and with sulfuric acid immediately prior to drying. Drying was performed in a conductive oven at  $130^\circ\text{C}$  under ventilation ( $525\text{ml min}^{-1}$ , corresponding to a headspace exchange rate of  $286\text{ times hour}^{-1}$ ) till a final DM content of 85%.

### Experimental setup for the pot trial

Six different solid SS or DS materials (raw, raw acidified with  $\text{Al}_2(\text{SO}_4)_3$ , raw acidified with concentrated  $\text{H}_2\text{SO}_4$ , dried, dried-acidified with  $\text{Al}_2(\text{SO}_4)_3$ , dried-acidified with concentrated  $\text{H}_2\text{SO}_4$ ) were mixed into a layer in pots containing 3 kg of a sandy loam soil. Mineral fertilized reference treatments with different NP fertilization rates were set up to evaluate the yield response and N and P uptake of maize.

At harvest, all aboveground biomass above 20 mm from the soil surface was cut, and dry matter was determined after oven-drying at  $60^\circ\text{C}$  for 96 h. The dry biomass was milled and analysed for total N. Total P and other elements were determined by ICP-OES after microwave digestion of biomass samples.

## RESULTS AND DISCUSSION

Acidification significantly increased  $\text{NH}_4^+\text{-N}$  in the dried DS and SS, from 18% in the non-acidified DS control up to 113% and 134% after DS acidification with concentrated sulfuric acid and  $\text{Al}_2(\text{SO}_4)_3$ , respectively (based on initial  $\text{NH}_4^+\text{-N}$  in the control) and from 76% to 100% and 112% after SS acidification with concentrated sulfuric acid and  $\text{Al}_2(\text{SO}_4)_3$ , respectively. Moreover, drying decreased Water extractable P (WEP) compared with raw material, by 44% and 36% in dried DS and SS, respectively. Surprisingly, acidification even intensified the decrease of WEP. The maize pot trials are ongoing and will be reported in the presentation.

## REFERENCES

- Case, SDC., Gómez-Muñoz B., Magid J., Jensen LS., 2016. Increasing thermal drying temperature of biosolids reduced nitrogen mineralisation and soil  $\text{N}_2\text{O}$  emissions. *Environ. Sci. Pollut. Res.*, 14: 14383-14392
- Pantelopoulos A., Magid J., Jensen LS., 2016. Thermal drying of the solid fraction from biogas digestate: Effects of acidification, temperature and ventilation on nitrogen content. *Waste Manag.*, 48: 218–226.
- Smith, D., Moore, P., 2001. Effects of alum and aluminum chloride on phosphorus runoff from swine manure. *J. Environ. Qual.* 30, 992–998.
- Smith SR., Durham E., 2002. Nitrogen release and fertiliser value of thermally-dried biosolids. *Water Environ. J.*, 16: 121–126.
- Regueiro I., Coutinh, J., Gioelli F., Balsari P., Dinuccio E., Fangueiro D., 2016. Acidification of raw and co-digested pig slurries with alum before mechanical separation reduces gaseous emission during storage of solid and liquid fractions. *Agric. Ecosyst. Environ.*, 227: 42–51.

## **A NOVEL PLATFORM PROVIDING SERVICES IN THE MEASUREMENT OF POTENTIALS FOR AMMONIA VOLATILISATION**

GENERMONT, S.<sup>1</sup>, DECUQ, C.<sup>1</sup>, FLURA, D.<sup>1</sup>, MASSON, S.<sup>1</sup>, ESNAULT, B.<sup>1</sup>, AUTRET, H.<sup>1,3</sup>

<sup>1</sup> UMR EcoSys INRA, AgroParisTech, Université Paris-Saclay, France; <sup>2</sup> IRHS, INRA, AgroCampus-Ouest, Université d'Angers, France

### **INTRODUCTION**

Ammonia emissions from crops are a major international environmental and sanitary concern. Their prevention and mitigation require a better knowledge and quantification of sources. But ammonia emissions due to agricultural practices are highly variable and make their quantification rather difficult. At the same time, the demand in reliable characterisation of ammonia volatilisation is growing: manufacturers are formulating new N fertilisers less susceptible to volatilisation; the quantity and variety of organic products are increasing, in relation with the increasing use in agriculture of a large variety of wastes in alternative ways of waste-disposal landfill or incineration and the emergence of new products in connection with industrial processes (e.g., energy production from biomass, agrofood industries).

There was a lack of reliable method adapted to the acquisition of references on ammonia volatilisation. That is the reason why we designed a laboratory volatilization set-up aiming at precisely characterizing the ability of any soil, commercial fertilizer or organic manure to volatilize in well controlled conditions, and thus aiming at helping decision making concerning its use in field for plant fertilisation. We are now able to propose a commercial offer for potentials of ammonia volatilisation in the novel platform of INRA Transfer, at EcoSys.

### **MATERIAL AND METHODS**

The laboratory set-up is based on the classical dynamic enclosures (Génermont et al., 2014). Volatilization is calculated following the mass balance principle: flux is the product of the sweeping air flow rate and the difference in ammonia concentration between the input and the output of the enclosure, divided by the experimental area. The originality and the advantage of this set-up compared to the existing ones are that it incorporates controls on most important parameters and has been automated for routine use.

First, the enclosure was specifically designed in order to (i) host either intact soil cores or reconstituted soils or even organic product alone and (ii) ensure the homogeneous contribution of the whole experimental surface. The substrate is contained in a 15 cm diameter ring leading to an experimental surface area of 177 cm<sup>2</sup>. Height can be adjusted from a few mm to several 10 cm. Experiments and numerical simulations were performed to design the head-space, optimising mass transfers, flow fields and exchange processes in laminar flow.

Then, emission conditions are controlled. The measurement enclosures are maintained at constant temperature in a thermostated incubator. The air which sweeps the enclosures is (i) purified (3 filters), (ii) brought to chosen a moisture (steam generator) and (iii) controlled to a desired flow rate 0-10 L min<sup>-1</sup>. For routine measurements, air temperature (15°C), humidity (95%) and flow rate (3.5 L min<sup>-1</sup>) were chosen as a better compromise between their known influence on ammonia volatilisation variation and technical constraints: particularly, humidity was chosen close to saturation to avoid substrate surface drying and artificial volatilisation reduction.

The concentration at the output is measured by trapping ammonia in acid solution in a continuous or sequential way to reduce the interventions. The analysis of the solutions is carried out later on at the laboratory.

The tests performed on the laboratory set-up show: (i) no ammonia contamination by the materials chosen, (ii) an acid trap bubbler efficiency of 100% and (iii) a recovery of ammonia of 97% ± 5%.



Fifteen enclosures are used simultaneously to characterize 4 substrates with 3 replicates per substrate, and carry out 1 reference treatment for quality control. The duration of a measurement is of a few days to a few weeks, depending on the duration of the volatilization event, with typically 5 sampling periods.

## RESULTS AND DISCUSSION

Measurements have been continuously carried out on various organic products and fertilizers from mid-2013. Ammonia volatilisation magnitude measured in the laboratory set-up is in the same order as the one measured in the field. The volatilisation dynamics is also well rendered. The set-up is well adapted to characterise various kinds of products and sort the potential of volatilisation, from very low ones (less than  $1 \text{ kg ha}^{-1}$ ) to very high ones (several  $100 \text{ kg ha}^{-1}$ ).

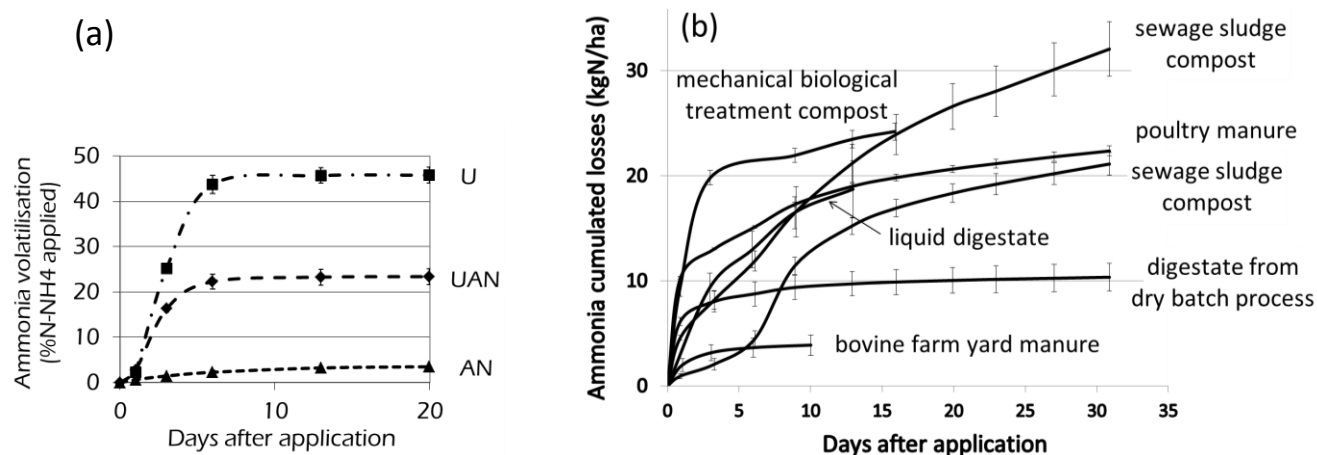

Figure 1. examples of results obtained using the laboratory set-up in case of (a) commercial mineral fertilisers on an alkaline reconstituted soil at  $18^{\circ}\text{C}$  or (b) various organic products on intact soil cores at  $15^{\circ}\text{C}$

## CONCLUSION

This set-up is thus well adapted to the objectives purchased i.e. the acquisition of references for new organic materials and mineral fertilisers. Measurements are being continuously carried out in order to produce references and typologies as regards volatilisation. The following step is to add to this set-up an integrated tool which will allow calculating the ammonia volatilisation encountered in real field conditions, useful for diagnosis, decision making and emission factor updating.

**Acknowledgements:** The work was partially granted within the “Volatilisation standard” project (Predicting ammonia volatilisation after fertilizer or organic manure application in the field: solving scientific and technical issues) by the French Agency for Environment and Energy ADEME (n° convention INRA - ADEME 1081C0030). Romain Cresson (INRA Transfert) is the manager of the commercial unit and leads the transfer process.

## REFERENCES

- Génermont S., 2014. Ammonia volatilisation after application of fertilisers and organic products: Potential for updating emission factors. In: Proceedings International Fertiliser Society 762, IFS International Fertiliser Society (no ISSN 1466-1314), Cambridge (UK), 12/12/2014, 44 p.
- Houot S., Parnaudeau V., Le Roux C., Servain F., Damay N., Jimenez J., Patureau D., Laville P., Génermont S., Thuriès L., Morvan T., Trochard R., Laurent N., Gattin I., Benbrahim M., Recous S., 2017. Protocole de caractérisation des produits résiduels organiques au laboratoire pour prédire leur comportement au champ. – Final Report. ADEME, 195p + annexes.

## **YIELD OF WINTER CROPS WITH LEGUMES MONOCROPPED AND INTERCROPPED WITH GRASSES: EFFECTS ON A SUBSEQUENT MAIZE CROP IN A DOUBLE CROPPING SYSTEM**

BÁEZ, M.D., GARCÍA, M.I., M. MELLA, GILSANZ, C.

INGACAL-Centro de Investigaciones Agrarias de Mabegondo (CIAM), A Coruña, Spain. E-mail: doloresbaez@ciam.es

### **INTRODUCTION**

In the temperate humid climate of Galicia (NW Spain), the dominant maize-Italian ryegrass double cropping system can be diversified by introducing other winter crops in the rotation (Botana *et al.*, 2016). Growing legumes such as winter pea or crimson clover can produce high dry matter yields, fix N<sub>2</sub> and positively affect subsequent crops (N'Dayegamiye *et al.*, 2015). The aims of the present study were to evaluate the performance of four winter crops in a maize forage system: monocultures of Italian ryegrass and of crimson clover, a mixture of these species and a triticale-pea mixture.

### **MATERIAL AND METHODS**

A five-year long field trial was established in the CIAM Research Centre (NW Spain), on a silt loam soil classified as Humic Cambisol. The average annual temperature in the study area is 13.3 °C and the average annual rainfall, 1128 mm (10-years average). A split plot design was used, with 4 replicates of each treatment. The main plots consisted of 4 winter treatments, R: Italian ryegrass (*Lolium multiflorum* L.), C: crimson clover (*Trifolium incarnatum* L.), a mixture of these species (R-C), and finally, a mixture of triticale (*x Triticosecale* Witt.) and pea (*Pisum sativum* L.)(T-P). The winter crops received a broadcast N fertilization (50 kg N/ha) at sowing, and only R received an additional 60 kg N/ha after the first cut (in March). The winter crops were harvested between the end of April and the middle of May. The maize crop was then planted at the end of May, and subplots were treated with two different rates of N fertilizer (0 and 160 kg N/ha) applied at maize establishment. Samples of winter crops and maize were collected at harvest for determination of dry matter (DM) yield and Kjeldahl N contents and for subsequent calculation of the N uptake by the crops. Samples of all winter crops were obtained, and subsamples of the mixtures were used to determine the proportions of grass and legumes.

### **RESULTS AND DISCUSSION**

#### **Dry matter yield of winter crops**

The DM yield of winter crops during the growth period is shown in Figure 1. In the monocultures, R produced the highest DM yield, except in the second year. Regarding the mixtures, R-C produced the highest yields. Considering the average values of the five years, C yielded 22% less than R in monoculture, and for the mixtures, T-P yielded 11% less than the R-C mixture. The N uptake in the C monoculture was on average 43.4% higher than in the R monoculture. N extraction was 23.6% higher in T-P than in R, but was not higher in the R-C mixture than in R.

#### **N uptake of maize (summer crop)**

In the maize crop, yield and N uptake were highest when the crop was preceded by C or the T-P mixture, with an increase in DM yield of 58% in treatments that did not receive N and 25% in those fertilized with 160 kg N/ha, relative to the maize crop planted after R. Similar results were observed for N uptake (Table 1): C and the T-P mixture increased the N uptake by 62% in the non-fertilized plots and by 26% in the fertilized plots. The N uptake was very low in the last two years, as a consequence of very dry weather in July.

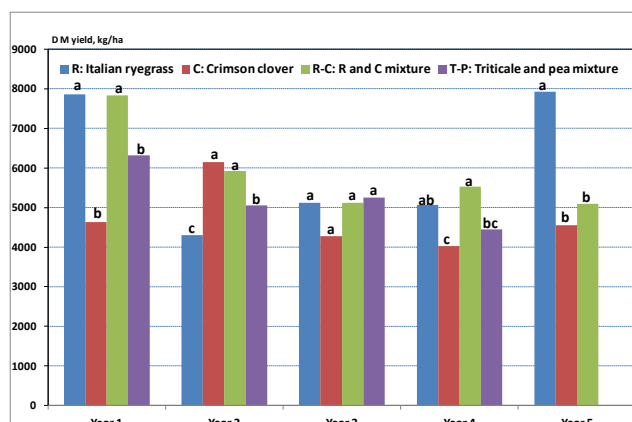

Figure 1. Dry matter yield of winter crops in each year during the field trial

Table 1. N uptake (kg N/ha) by maize crops in each year during the field trial

Preceding Winter crop <sup>1</sup>	Fertilization Maize <sup>2</sup>	N uptake, kg N/ha				
		Year 1	Year 2	Year 3	Year 4	Year 5
R	0	37.3	36.0	37.9	29.8	26.9
C	0	76.4	46.1	67.7	55.2	40.1
R-C	0	35.9	38.1	36.8	29.2	22.6
T-P	0	58.3	50.3	63.1	49.0	38.1
R	160	80.0	63.8	124.8	68.7	37.0
C	160	93.7	83.4	140.9	97.2	53.2
R-C	160	76.7	70.9	127.3	75.2	36.9
T-P	160	91.9	80.2	159.2	93.4	49.4
Significance <sup>3</sup>						
WC		**	ns	*	**	*
FM		***	***	***	***	***
WC*FM		*	ns	ns	ns	ns

<sup>1</sup>Winter crop (WC): R: Italian ryegrass, C: Crimson clover, R-C: R and C mixture, T-P: triticale - pea mixture. <sup>2</sup>Fertilization Maize (FM): Calcium ammonium nitrate 27%. <sup>3</sup>Sig.:\*\*\* (p<0,001); \*\* (p<0,01); \* (p<0,05); ns, no sig.

## CONCLUSION

The results of a medium-term experiment (five years) with intensive forage rotations based on maize as a summer crop and four winter crops showed that incorporation of monoculture legume crops, such as crimson clover or a pea-triticale mixture, during winter increased dry matter yield and nitrogen uptake in the subsequent maize crop relative to those obtained in the conventional ryegrass-maize rotation.

**Acknowledgements:** “Xunta de Galicia”: 10MRU503001PR project and actions: 2015/96, 2016/119. Spanish National Institute for Agricultural and Food Research and Technology under project: RTA2015-00058-C06-01.

## REFERENCES

- Botana A., Valladares J., Pereira-Crespo S., Díaz N., Resch C., Fernández-Lorenzo B., Dagnac T., Veiga M., Flores-Calvete G., 2016. Annual legumes mixtures can improve the productivity of the rotation italian ryegrass-forage maize. In: Báez et al (Eds.), Innovación sostenible en Pastos: Hacia una Agricultura de respuesta al cambio climático, Lugo-A Coruña 26-29 April 2016, pp. 81-86.
- N'Dayegamiye A., Whalen J.K., Tremblay G., Nyiraneza J., Grenier M., Drapeau A., Bipfubusa M., 2015. The benefits of legume crops on corn and wheat yield, nitrogen nutrition, and soil properties improvement. *Agron. J.*, 107 (5), 1653-1665.

## IMPLICATIONS OF THE COVER CROP TERMINATION DATE ON N AND WATER CYCLES

ALONSO-AYUSO, M<sup>1</sup>, QUEMADA, M<sup>1</sup>, VANCLOOSTER<sup>2</sup>, M, RUIZ, M<sup>1</sup>, RODRIGUEZ, A<sup>3</sup>, GABRIEL, J.L.<sup>4</sup>,

<sup>1</sup> Universidad Politécnica de Madrid, Spain; <sup>2</sup> Universidad catholique de Louvain, Belgium; <sup>3</sup> Universidad de Castilla-La Mancha, Spain; <sup>4</sup> INIA (INAGEA-CEIGRAM), Spain,

### INTRODUCTION

The cover crop (CC) termination date (TD) is a key management tool to enhance some of CC benefits such as soil water conservation and N recycling, and to minimize risks as the pre-emptive competition of CC with subsequent cash crops. However, the optimum date depends on annual meteorological conditions, and climate variability induces uncertainty in a decision that needs to be taken every year. One of the most important cover crop benefits is reducing nitrate leaching, a major concern for irrigated agricultural systems and highly affected by the termination date. This study aimed to determine the effects of cover crops and their termination date on the water and N balances of an irrigated Mediterranean agroecosystem under present and future climate conditions. Understanding the TD management in different scenarios and climatic conditions would be useful to achieve efficient management strategies.

### MATERIAL AND METHODS

The crop growth, water transport and nitrogen modules of WAVE model were calibrated by inverse calibration and validated with six years of soil water content and soil inorganic N data from two previous field experiments [1,2]. Simulations were performed for current climatic conditions (with a 30-year database) and for climate change projections, combining different strategies: fallow vs. winter CC with different TD (from March 1<sup>st</sup> to April 14<sup>th</sup>) and different hypothetical planting dates (HPD; April 15<sup>th</sup> and May 1<sup>st</sup>) for the main crop. Besides, other factors were combined: different initial soil water and N content in autumn; and two different planting dates of the subsequent cash crop. The cumulated biomass and CC transpiration, drainage, leaching, and N and water content in the upper soil layer previous to the cash crop planting were the variables evaluated.

### RESULTS AND DISCUSSION

The modelling errors of the observed system properties were usually smaller than the observed field variability, reinforcing the efficiency of the model for simulating the behaviour of this cropping system. The application of a validated model to the 40 agronomical scenarios and the 30-year baseline weather time series confirmed the importance of the termination date of the cover crop to maximize cover crop benefits [3]. Significant differences were found in cover crop outputs (cumulated biomass and transpiration), percolation water and leaching, and in both soil water content and  $N_{min}$  at HPD, suggesting an increase in the competition with the following cash crop (Table 1). Moreover, the CC treatments always reduced percolation of water and nitrate leaching compared to fallow treatment (Table 1). However, the simulated reduction was larger when the soil or/and the climatic conditions favoured large leaching periods. This leaching appeared to be very dependent on soil autumn conditions as values were very variable depending on the autumn soil N and water content. The scenario analysis also suggested that high nitrate leaching during the intercropping period could occur, in particular when two or more adverse situations were combined, especially high initial  $N_{min}$  and water in autumn with high rainfall in winter. The CC effect on nitrate leaching reduction was mostly produced during the first months of the CC period, because early termination dates and late HPD had a very small effect on the final nitrate leaching. So, if the effect of the termination date on nitrate leaching is small, early cover crop termination could be a valid option, allowing farmers more time for performing the required soil management, but also allowing crop residues to mineralize and the soil to reduce water and nutrient competition.

*Table 1. Effect of termination date (TD) and cash crop sowing date (HPD) on the decrease of N leaching and  $N_{min}$ /soil water content (SWC) at 20-cm seed bed and at cash crop sowing date under current climatic conditions. The values represent the 10%/90% percentile decrease with average decrease in brackets. The reference is the scenario with early HPD and no CC.*

TD	HPD	Leached N (kg N ha <sup>-1</sup> )	$N_{min}$ (kg N ha <sup>-1</sup> )	SWC (%)
early	early	33/99 (57.3)	2/14 (8.9)	5.5/3.0 (5.0)
late	early	35/112 (63.0)	5/22 (15.0)	12.3/16.8 (14.0)
early	late	31/91 (50.6)	0/11 (3)	3.3/3.0 (3.0)
late	late	35/111 (61.7)	4/20 (13.2)	8.8/12.0 (10.0)

Based on the results obtained in this study under different climate change scenarios, we conclude that cover crops tend to grow more and faster, mostly because of increasing temperature through a period where temperature is the most limiting factor. This possible biomass increase also affects both nitrate leaching (reducing) and pre-emptive competition with the subsequent cash crop (increasing), but it could also improve the weed suppression capacity and the C sequestration. With respect to the effect on nitrate leaching and pre-emptive competition, the simulated climatic change scenarios tended, in general, to increase the differences between the cover crop and fallow treatment. Therefore, the competition for N with the subsequent cash crop was not so important for most of the management scenarios. Soil water content at HPD was also affected in the climate change scenarios, but differences between fallow and cover crop treatments only increased when the temperature increased. Indeed, rainfall variation equally affects fallow and cover crop treatments. Therefore, under different climate change scenarios, fallow tends to increase pre-emptive competition with the subsequent cash crop and to increase nitrate leaching risk, while cover crops tend to be more resilient, maintaining their pre-emptive competition levels but reducing nitrate leaching with respect to the current situation. Therefore, the use of cover crops was confirmed as a meaningful strategy to climate change adaptation.

## CONCLUSION

The TD delay caused a greater CC biomass that led to a higher resources extraction, which was considered an environmental advantage by reducing the risks of leaching and drainage, but at the same time it constituted a risk by enhancing pre-emptive competition with the main crop, mainly in scenarios in which water and N were limiting soil resources. The cash crop planting date showed to be relevant, because it allowed reducing N and water competition. With climate change projections, the CC efficiency in leaching and drainage reduction was enhanced but at the same time the risk of soil depletion increased. Therefore, the CC termination date was confirmed as a key management tool and showed to have relevant implications with climate change scenario projection.

**Acknowledgements:** Project founded by Spanish Ministry (AGL2017-83283-C2), Comunidad de Madrid (S2013/ABI2717). We would also like to thank the staff from La Chimenea field station (IMIDRA).

## REFERENCES

- Gabriel, J.L., Muñoz-Carpena, R., Quemada, M., 2012. The role of cover crops in irrigated systems: Water balance, nitrate leaching and soil mineral nitrogen accumulation. *Agric. Ecosyst. Environ.* 155, 50-61.
- Alonso-Ayuso, M., Gabriel, J.L., Quemada, M., 2014. The kill date as a management tool for cover cropping success. *Plos One* 9, 12
- Alonso-Ayuso M., Quemada M., Vancloster, M., Ruiz-Ramos, M., Rodríguez, A., Gabriel J.L., 2018. Assessing cover crop management under actual and climate change conditions. *Sci. Total Environ.* 621, 1330-1341.

## FERTILIZER STRATEGIES TO IMPROVE NUE IN GRAZED DAIRY PASTURES

SMITH, A. P.<sup>1</sup>, CHRISTIE, K. C.<sup>2</sup>, RAWNSLEY, R. P.<sup>2</sup>, ECKARD, R. J.<sup>1</sup>

<sup>1</sup>The University of Melbourne, Australia; <sup>2</sup>Tasmanian Institute of Agriculture, Australia

### INTRODUCTION

Since the early 1990s there has been a significant increase in the amount of N fertilizer used by pasture-based dairy farmers in Australia. However, there is a mounting body of evidence that N fertilizer is being used inefficiently at the farm scale to produce pasture dry matter (DM) for grazing pure-grass grasslands (Gourley et al., 2012). This comes at a time when there are drastic imperatives to reduce input costs, and although N use is not regulated in Australia, there is increasing scrutiny of the potential risk for agricultural industries to pollute.

One of the avenues that has been proposed to increase the nitrogen use efficiency (NUE) of pasture (i.e. pasture produced per unit of N fertilizer relative to a zero treatment), is using agro-environmental information. It has been suggested that the use of 'sensors' available to farmers to determine how and when to apply fertilizers is *preferable* to a recipe-book approach of fixed fertilizer applications. Many farmers are sometimes overwhelmed and unconvinced by the different options, and unsure about how best to modify their fertilizer management. Therefore, they continue to use a flat rate of fertilizer across the year. The value proposition of different approaches is needed for grazed pastures. Therefore, we conducted a modelling study to compare the growth rate response, N loss and NUE of fertilizer strategies which used increasing knowledge of soil N mineralisation and environmental conditions in different ways. The working hypothesis was that applying N fertilizer using strategies based on increasing levels of environmental information and sophistication will improve NUE, reduce N losses and reduce N inputs required to maintain production.

### MATERIAL AND METHODS

This study used DairyMod v 5.7.5 (Johnson 2016) to compare 7 fertilizer strategies using a plot study grazed by dairy cows: (1) *Zero rate* (ZR): no fertilizer applied, (2) *Flat rate* (FR): a rate of 40 kg N/ha (rainfed) or 50 kg N/ha (irrigated) applied after every grazing event, (3) *Seasonally modified* (SM): The N rate varied according to season with a fixed rate across all years, (4) *Precision agriculture - soil* (Ps): N fertilizer was applied at 30 kg/ha when the soil available N concentration fell below 20 mg/kg in the top 15cm, and then was not applied for at least 21 days, (5) *Precision agriculture - plant* (Pp): N fertilizer applied at 30 kg/ha when live leaf N concentration drops below 90% of optimum (i.e. a level at which plant growth potential is 10% limited by N efficiency) and then was not applied for at least 21 days, (6) *Daily - plant* (Dp): as for Pp above except N fertilizer was applied daily, and (7) *Daily - soil* (Ds): as for Ps above except N fertilizer was applied daily. The same treatments were repeated at Terang - rainfed site - and Mt Gambier – an irrigated site. The simulations were conducted from 1997 to 2017.

### RESULTS AND DISCUSSION

There was little difference ( $18.8 \pm 0.9$  t/ha/yr;  $11.3 \pm 0.6$ ) in the long term annual DM production between the strategies on an annual basis or seasonal basis; with both locations showing similar relative differences between the strategies compare to FR. For the rainfed location, summer DM production differed most between the strategies (CV of 9%) and autumn the least (CV of 3%), whereas for the irrigated location winter (CV of 7%) and spring/summer were (4%) across all years and strategies. N fertilizer amounts applied differed between strategies; with the variation being consistently great between locations during autumn, and least during spring. In Terang, the SM strategy required 50% less N fertilizer annually than the FR strategy – at Mt. Gambier this was 30% less. The Dp strategy required the least annual N fertilizer at the irrigated location, while at the rainfed location the SM strategy required the least. Some seasonal differences existed: overall the strategies informed by soil information,

required more fertilizer (particularly in autumn) than those based on plant requirements. At the rainfed location in most years (78%) there was a need for fertilizer in summer (mostly in December) using the variable strategies; however, in autumn only one year in 18 justified N fertilizer based on Pp and about a third of the years based on Ps. Therefore, cost savings and realized opportunities occurred with the precision strategies that would not have been possible with other strategies. There were large differences in the total N losses between strategies during spring and the least differences during autumn.

In terms of NUE, all the strategies showed a significant improvement over the FR strategy (Figure 1). The SM led to large improvement in NUE of 5 kg DM/kg N in the case of Terang and 5 kg DM/kg N for Mt. Gambier. The Dp strategy was the most (or equal most) efficient across all locations overall. Across both locations, strategies informed by plant based information (i.e. Pp, Dp) were 16% efficient than based on soil information (i.e. Ps, Ds).

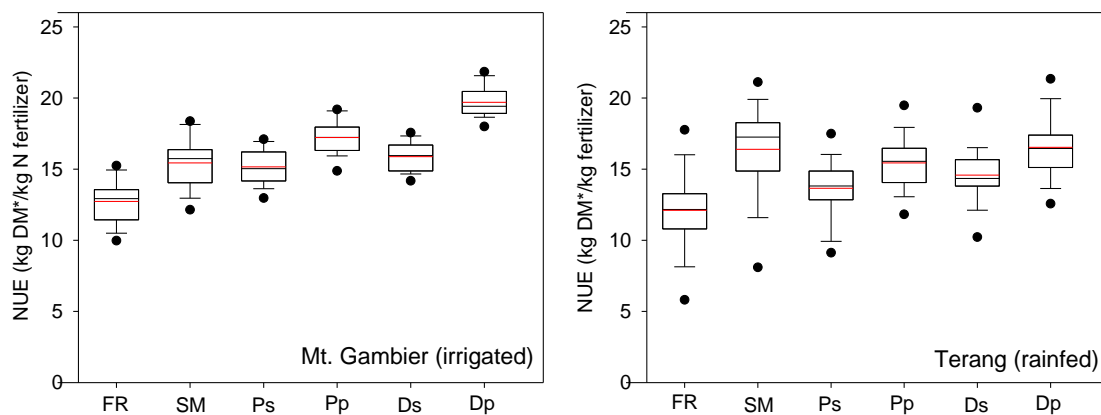

Figure 1. Long term annual NUE of 7 different fertilizer strategies at an irrigated and rainfed location (NUE; kg DM\*/kg N fertilizer). \* indicates that the response is relative to a zero-fertilizer treatment.

## CONCLUSION

Fertilising strategies developed per plant N requirements were the most efficient, however at rainfed locations the high variability of response made it difficult in some years to differentiate between responses. The use of precision fertilizer management strategies has value in terms of reducing fertilizer use and loss during autumn and to a lesser extent summer, with the least value in winter.

**Acknowledgements:** The ‘More Profit from Nitrogen: enhancing the nutrient use efficiency of intensive cropping and pasture systems’ project was supported by funding from Dairy Australia and the Australian Government Department of Agriculture and Water Resources as part of its Rural R&D for Profit program.

## REFERENCES

- Johnson IR (2016) DairyMod and the SGS Pasture Model: a mathematical description of the biophysical model structure. IMJ Consultants, Dorrigo, NSW, Australia.  
[http://imj.com.au/wp-content/uploads/2016/05/DM\\_SGS\\_documentation.pdf](http://imj.com.au/wp-content/uploads/2016/05/DM_SGS_documentation.pdf)  
 Gourley, C.J.P., Dougherty, W.J., Weaver, D.M., Aarons, S.R., Awty, I.M., Gibson, D.M., Hannah, M.C., Smith, A.P., Peverill, K.I., 2012. Farm-scale nitrogen, phosphorus, potassium and sulfur balances and use efficiencies on Australian dairy farms. *Animal Production Science* 52, 929-944.

## MODELLING THE EFFECT OF WIDE RANGING DRIP IRRIGATION REGIMES AND N-FERTIGATION RATES ON POTATO GROWTH AND PRODUCTION ON A COARSE SAND

MOTARJEMI, S.K.<sup>1</sup>, ZHOU, Z.<sup>2</sup>, ANDERSEN<sup>1</sup>, M.N., PLAUBORG, F.<sup>1</sup>

<sup>1</sup> Department of Agroecology, Aarhus University, Denmark; <sup>2</sup> Department of Agricultural Research for Northern Sweden, Swedish University of Agricultural Sciences, Sweden

### INTRODUCTION

To achieve satisfactorily high yields of potato in Denmark, high amounts of nitrogen (N) fertiliser are needed. However, studies have shown that potato production causes a high-risk of N loss by nitrate leaching not only after harvest, but also during the growing season when heavy rainfalls occur (Haverkort and MacKerron, 2000). To mitigate this risk, drip irrigation and N-fertigation offer a more precise allocation of both water and N. Potentially high water and N use efficiencies might be achieved, if predictive tools such as crop models can estimate the need for water and N accurately. Hence, the objective of this study was to set up the Daisy model (Hansen et al., 2012) and to test the model performance using data from a field experiment on drip irrigated and N fertigated potatoes.

### MATERIAL AND METHODS

Data from a field experiment with multiple treatments in drip and N fertigated potatoes (Zhou et al., 2016) was used. However, this paper only allowed presentation of results on crop growth and soil water content from two of the treatments in 2013 and 2014. The high input treatment (I1N4) was fully irrigated (determined from TDR measurements) with a N input of 180 kg N ha<sup>-1</sup> applied as split N, 40 kg N (NPK) at planting of the mother tubers and then seven times 20 kg N ha<sup>-1</sup> every week (NH<sub>4</sub>NO<sub>3</sub> and CaNO<sub>3</sub>, N ratio 1:2). The low input treatment (I0N0) had no input of irrigation water and nitrogen. The Daisy model calibration (Heidmann et al., 2008) was improved as measured leaf area index (LAI) development has been taken into account by calibration on data from 2014. The need for calibration of effective hydraulic parameters (Djurhuus et al. 1999), especially, the saturated hydraulic property and the form of the unsaturated hydraulic conductivity curve (the I parameter in Van Genuchten-Mualem equation) were evaluated by comparing measured and simulated soil water dynamics.

### RESULTS AND DISCUSSION

Figure 1a. shows that negative I (= -0.58) for the C-horizon drained the soil (0-0.8 m layer) to a too low soil water content, and I was calibrated to 1.18. Figure 1c. shows that the old LAI equation in Daisy was in error, especially later in the growing season. Hence, another LAI equation in Daisy was parameterised by calibration resulting in a more realistic Fm parameter (photosynthetic capacity = 4.0) instead of the unrealistically high 4.8 found by

Table 1. Measured and simulated dry matter yield for tuber (Meas. DM Yield and Daisy DM Yield, respectively). Measured and simulated nitrogen yield for tuber (Meas. N Yield and Daisy N Yield, respectively)

Treatment	2014		2013	
	I0N0	I1N4	I0N0	I1N4
Irrigation (mm)	0	92.71	0	117.35
Amount of Nitrogen (kg.ha <sup>-1</sup> )	0	180	0	180
Meas. DM Yield (Mg.ha <sup>-1</sup> )	3.3	9.8	3.0	9.3
St. Error of The Mean	0.3	0.2	0.6	0.9
Daisy DM Yield (Mg.ha <sup>-1</sup> )	2.8	10.0	2.8	8.8
Meas. N Yield (kg.ha <sup>-1</sup> )	34.4	130.5	28.3	129.5
St. Error of The Mean	4.2	2.9	6.0	12.7
Daisy N Yield (kg.ha <sup>-1</sup> )	22.3	133.9	27.4	124.2



Heidmann et al. (2008). The improved Daisy model was then tested on data from the I1N4 and I0N0 treatment in 2014 (Fig. 1b,d-h) and the final DM and N yield (measured and simulated) from both 2014 and 2013 were compared (Table 1).

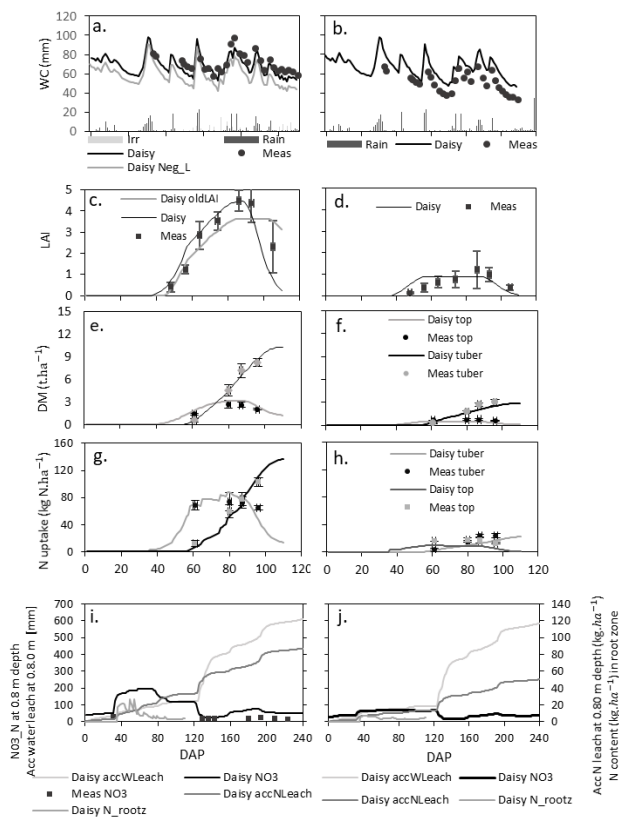

Figure 1. For I1N4 and I0N0, respectively, dynamics during the growing season of observed and simulated: a,b Soil water content. Neg\_L indicates neg. I in VG-Mualem before calibration. c,d Leaf area index. OldLAI, curve before calibration. e,f Dry matter yield in top and tuber. g,h Nitrogen yield in top and tuber. Error bars in all plots indicate the standard deviation.

## CONCLUSION

The calibration of hydraulic parameters resulted in better correlation between observed and simulated data for N uptake and dry matter production in potato during the season and final dry matter and N yield. With correct optimization of input parameters, Daisy could perform as a strong drip and N-fertigation decision support tool for farmers growing potato on coarse sand in temperate climate.

## REFERENCES

- Djurhuus, J., Hansen, S., Schelde, K., Jacobsen, O.H., 1999. Modelling the mean nitrate leaching from spatial variable fields using effective parameters. *Geoderma*. 87, 261–279.
- Haverkort, A. J. and MacKerron, D. K. L. (eds.), 2000: Management of nitrogen and water in potato production. Wageningen Pers, Wageningen, The Netherlands, 353 pp., ISBN 90-74134-77-7
- Heidmann, T., Tofteng, C., Abrahamsen, P., Plauborg, F., Hansen, S., Battilani, A., Coutinho, A.J., Doležal, F., Mazurczyk, W., Ruiz, J.D.R., Takác, J., 2008. Calibration procedure for a potato crop growth model using information from across Europe. *Ecol. Model.* 211, 209–223.
- S. Hansen, P. Abrahamsen, C.T. Petersen, M. Styczen, 2012. Daisy: model use, calibration, and validation. *Trans. ASABE*, 55, pp. 1315-1333.
- Zhou, Z., Andersen, M.N., Plauborg, F., 2016. Radiation interception and radiation use efficiency of potato affected by different N fertigation and irrigation regimes. *Eur. J. Agron.* 81, 129–137.

## **NITROGEN INPUT MAPPING AT THE FIELD SCALE USING REMOTELY PILOTED AIRCRAFT SYSTEMS IMAGERY**

MAIRE J.<sup>1,2,3,4</sup>, GIBSON-POOLE S.<sup>2,3</sup>, COWAN N.<sup>4</sup>, RICHARDS K.<sup>2</sup>, SKIBA U.<sup>4</sup>, REES R.M.<sup>2</sup>, REAY D.S.<sup>3</sup>, LANIGAN G.<sup>1</sup>

<sup>1</sup> Teagasc Johnstown Castle, Environmental Research Centre, Co. Wexford, Y35 TC97, Ireland, <sup>2</sup> Scotland's Rural College, West Mains Road, Edinburgh, EH9 3JG, Scotland, <sup>3</sup> University of Edinburgh, Alexander Crum Brown Road, Edinburgh, EH9 3FF, Scotland, <sup>4</sup> Center of Ecology and Hydrology, Bush Estate, Penicuik EH26 0QB, Scotland

### **INTRODUCTION**

Knowledge of the spatial heterogeneity of soil nitrogen at the field scale is important when determining nitrogen loss dynamics and the spatial variability of nitrous oxide (N<sub>2</sub>O) emissions. Understanding the spatial distribution of key nitrogen inputs such as synthetic fertiliser and the randomly spaced deposition of livestock urine or dung is fundamental in assessing potential nitrogen losses. Typical apportionment values as a percentage of the deposited urinary nitrogen are estimated as: 13 % ammonia volatilization; 2% N<sub>2</sub>O emission; 20 % leaching nitrate; 41 % pasture uptake and 26 % gross immobilization (Selbie et al. 2015). However, monitoring of urine deposition at the field scale is difficult due to the fact that the urine itself is not visible in the soil. Capturing field scale variability of available nitrogen using traditional methods is labour intensive and requires costly laboratory analyses; however, urine deposition has visible consequences on growth, colour and density of the grass (Moir et al. 2011) so may serve as a useful proxy for urine and dung deposition. The grass growth response depends significantly on soil type, soil moisture content, seasonal climatic conditions and the nitrogen content of the deposition (Clough et al. 2004). The method developed in this project is based on the detection of grass growth response areas from the urine or dung deposition, which are referred to as patches. Urine and dung patch distribution have been studied before from either single short term grazing event or with intensive field work (Li et al. 2012; Misselbrook et al. 2016). The objective of this study was to exploit Remotely Piloted Aircraft System (RPAS) technology to map urine and dung deposition at the field scale without the need for intensive sampling strategies. The resulting nitrogen input was monitored to assess the impact of nitrogen input on grass growth, grass quality and potential nitrogen losses to the environment. The use of RPAS can offer images of the urine and dung patch distribution using an object detection script which is applied to construct a deposition map and to study the overlapping of patches and to monitor the evolution of each patch during the grazing season.

The main aim of this study was to determine the potential of the RPAS method to measure urine and dung patch cover over two different grazing systems (sheep and dairy cows grazed fields) and to create an indicative nitrogen input map for these systems.

### **MATERIAL AND METHODS**

#### **Field survey using RPAS**

In this project, RPAS was used to identify urine and dung patches in a 2 ha field (Johnstown Castle farm, Ireland) and in a 5 ha field (Easter Bush, Scotland), which had been grazed by dairy cows and sheep respectively. The field was surveyed regularly over the grazing season of 2017 in Ireland and in a single occasion in April 2016 in Scotland. In Scotland, the RPAS was a hexa-copter mount with a twin camera system and was used to identify urine patches in a field which had been grazed by sheep (47 ewes and 90 lambs for seven weeks) three weeks previously. The preliminary results presented in this abstract correspond to this survey only.

#### **Image object detection script**

Urine and dung patch detection on the images collected by the RPAS was completed in a three main steps: 1) stitch the pictures collected to create a unique orthoimage for each survey; 2) run the object detection code to select areas in the orthoimage corresponding to the patches; 3) aggregate data about the patches detected. This method was designed to study coverage, size, colour, and timing of the patches. The object detection code was

developed specially for this purpose in the freely available statistical software *R* (the R foundation, USA). The image analysis is based on the *Kmeans* clustering method which group together pixels of the images which have similar colour information. For more accuracy, the code was run on vegetation colour indices (such as Normalized Difference Vegetation Index, Red Excess Index and Near Infra-red) were calculated from the images taken by the RPAS.

## RESULTS AND DISCUSSION

The results were summarised to construct a map highlighting the size and colour properties of the urine patches. The imagery of four samples of approximately 50 m<sup>2</sup> areas within the field were analysed using a custom pixel based model using colour channel thresholding and *Kmeans* clustering. For a total of 210 m<sup>2</sup> of grassland, 4.12 % of the total area was considered influenced by urine events, with 82 individual patches. The urine patch coverage has been used for a simple interpolation of N<sub>2</sub>O emissions using IPCC Tier 1 emission factor (EF) for urine deposition ((EF = 1 % of nitrogen deposited) and fertiliser Ammonium Nitrate (EF = 2 % of nitrogen amended). In this equation, two urine nitrogen loadings were used, with a minimum value of 500 kg N.ha<sup>-1</sup> for the area touched by urine and a maximum value of 1089 kg N.ha<sup>-1</sup> as reported by Selbie et al. 2015. The total N<sub>2</sub>O emissions for this period were estimated between 1.19 kg N<sub>2</sub>O.ha<sup>-1</sup> and 1.78 kg N<sub>2</sub>O.ha<sup>-1</sup> based on the reported emission factors.

## CONCLUSION

Mapping nitrogen deposition at the field scale enable farmers to adapt their practices to improve nutrient management and optimise production with a reduced environmental impact. However, low-cost accessible tools are required to provide farmers with the information required to make these management decisions. RPAS imagery can deliver for a low cost and in a limited time an accurate tool to study and manage field nutrient input; however, in the case of grazed grasslands the challenge is bigger due to the high spatial variability of the terrain. The preliminary results of this study showed a high potential to create precise images of urine and dung patches, which account for much of the spatial variability of nitrogen deposition in grazed pasture. This method shows potential to aid automatic and fast determination of patch cover at the field scale, providing information which is essential for a better spatial modelling of available nitrogen and ultimately reducing nitrogen losses in agriculture.

**Acknowledgements:** The authors gratefully acknowledge the University of Edinburgh farm manager Wim Bosma for allowing access to the Easter Bush study field and to Johnstown Castle technical staff in the management of the livestock throughout the trial. Valuable assistance was also provided by the Biomathematics and Statistics Scotland, BioS. Funding for this study was provided by the Walsh fellowship program by Teagasc, Ireland.

## REFERENCES

- Clough, T.J. et al., 2004. Lime and Soil Moisture Effects on Nitrous Oxide Emissions from a Urine Patch. *Soil Science Society of America Journal*, 68(5), pp.1600–1609.
- Li, F.Y. et al., 2012. Effects of nitrogen load variation in animal urination events on nitrogen leaching from grazed pasture. *Agriculture, Ecosystems and Environment*, 159, pp.81–89.
- Misselbrook, T. et al., 2016. Agriculture , Ecosystems and Environment Automated monitoring of urination events from grazing cattle. *“Agriculture, Ecosystems and Environment”*, 230, pp.191–198.
- Moir, J.L. et al., 2011. The spatial coverage of dairy cattle urine patches in an intensively grazed pasture system. *The Journal of Agricultural Science*, 149(2011), pp.473–485.
- Selbie, D.R., Buckthought, L.E. & Shepherd, M.A., 2015. *The Challenge of the Urine Patch for Managing Nitrogen in Grazed Pasture Systems*, Elsevier Ltd.

## **MANURE N PLAYS A DUAL ROLE IN C STABILIZATION AND N SUPPLY SOIL FUNCTIONS – EVIDENCE FROM LONG-TERM FIELD STUDIES**

CHANTIGNY, M.H., ANGERS, D.A.

<sup>1</sup> Agriculture and Agri-Food Canada, Québec Research and Development Centre, Canada

### **INTRODUCTION**

The potential contribution of agricultural soils in mitigating climate change through carbon (C) sequestration has recently received much interest. However, sequestering more C requires nitrogen (N) input to meet stoichiometric balances. Considering the general consensus that we must learn to grow more food with lower reactive N inputs, an apparent paradox appears between expected soil functions of mitigating climate change (C storage function) and growing food (N supply function). Recent research suggests that both functions may actually co-exist in integrated crop-livestock systems through efficient use of manure nutrients. For instance, it has recently been suggested that microbial peptidic N plays a central role in C stabilization in mineral-organic associations (MOAs) (Knicker, 2011; Kopittke, 2017). The presence of microbial metabolites in manure could therefore foster C accumulation in soils. In parallel, it is recognized that repeated manure application leads to the accumulation of organic N in soils that is eventually restituted and may become a major source of N for crops (reviewed by Webb et al., 2013). More field-based evidence is however required to determine whether and how livestock manure can actually sustain C storage and N supply soil functions at the same time.

### **MATERIAL AND METHODS**

A conceptual model was constructed, based on findings in previous long-term field experiments (>15 y), to propose possible C and N flows and mechanisms underlying C and N accumulation and restitution in soils fertilized with or without manure (Fig. 1). The long-term studies used either <sup>15</sup>N-labelling/tracing techniques to determine the soil N supply capacity (e.g., Nyiraneza et al., 2010), or physical fractionation schemes to explore the physical location of accumulated C and N (e.g., Maillard et al., 2015).

### **RESULTS AND DISCUSSION**

#### **Soil N supply capacity – Nyiraneza et al., 2010**

Results showed that, after 28 y of cropping history, plant N uptake was 50 kg ha<sup>-1</sup> greater in arable soils receiving mineral fertilizers plus 20 m<sup>3</sup> ha<sup>-1</sup> yr<sup>-1</sup> dairy manure than in soils with mineral fertilizers only (same amounts of available N). This difference increased to 150 kg N ha<sup>-1</sup> in cropping systems including a grassland phase, indicating that the legacy effect of past manure applications provided a substantial portion of crop N requirements. Inefficient use of this legacy N is likely to increase emissions of reactive N through leaching and greenhouse gas emissions, stressing the need to better predict its contribution to crop N uptake and adjust fertilizer recommendations accordingly (Webb et al., 2013).

Nyiraneza et al. (2010) also demonstrated that in manured soils, the legacy effect increased disproportionately compared to the gain in soil total N, and that a gain of 20 to 50% in soil total N was associated with a 200 to 400% increase in the soil N supply capacity. This finding suggests that the nature or location of accumulated N is not homogeneous in soil. It is hypothesized that N accumulated in manured soils, and contributing to the legacy effect, may be concentrated in a specific fraction of soil organic matter.

#### **Physical localization of stored C and N in soils – Maillard et al., 2015**

The results showed that more C and N accumulate in soils amended with liquid dairy cattle manure than with mineral fertilizers. This finding calls for a specific role of manure C and N. In agreement with Knicker (2011) and

Kopittke (2017), we suggest that the fraction of manure organic N comprised of microbial metabolites is directly involved in the formation of MOAs (Fig. 1).

Using a soil physical fractionation scheme, Maillard et al. (2015) found that while a major portion of C and N accumulated in fine (silt+clay) MOAs, differences between mineral fertilizer and manure were especially large in the coarse (sand-size) MOAs. Carbon and N found in coarse MOAs could conceptually be seen as more labile than in fine MOAs. We hypothesize that while C and N found in fine MOAs is stable [physically recalcitrant], coarser MOAs represent a smaller but more dynamic portion of soil C and N directly involved in the soil N supply capacity (Fig. 1). By extension, it can be hypothesized that manure N compounds play a dual role depending on their origin (e.g., N in mineral forms, in undigested feed and beddings, or in microbial/digestive tract excreta) and physical location in either fine (C stabilization) or coarse (N supply) MOAs.

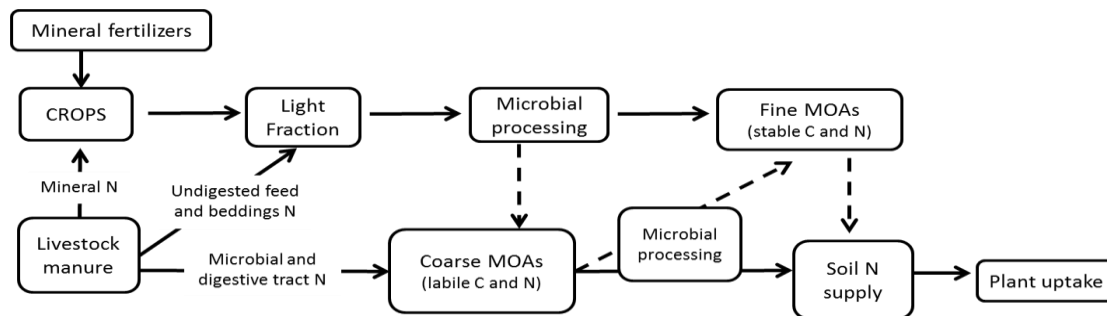

Figure 1. Conceptual model on possible mechanisms and role of manure N in C Storage and N supply soil functions. Solid lines represent primary paths; dashed lines represent secondary paths.

## CONCLUSION

The results indicate that repeated use of dairy cattle manure favors the accumulation of C and N in soil. We suggest that C and N located in coarse MOAs are more dynamic and directly involved in the legacy effect and soil N restitution to crops, whereas C and N located in fine MOAs are more stable. More work is needed to confirm these hypotheses and to explore the influence of manure type, and climate and soil conditions.

## REFERENCES

- Knicker H., 2011. Soil organic N – An under-rated player for C sequestration in soils? *Soil Biol. Biochem.* 43, 1118-1129.
- Kopittke P.M., 2017. Nitrogen-rich microbial products provide new organo-mineral interactions for the stabilization of soil organic matter. *Global Change Biol.* doi:10.1111/gcb.14009.
- Maillard E., Angers D.A., Chantigny M.H., Bittman S., Rochette P., Lévesque G., Hunt D., Parent L.E., 2015. Carbon accumulates in organo-mineral complexes after long-term liquid dairy manure application. *Agric. Ecosyst. Environ.* 202, 108-119.
- Nyiraneza J., Chantigny M.H., N'Dayegamiye A., Laverdière M.R., 2010. Long-term manure application and forages reduce nitrogen fertilizer requirements of silage corn – cereal cropping systems. *Agron. J.* 102, 1244-1251.
- Webb J., Sorensen P., Velthof G., Amon B., Pinto M., Rohde L., Salomon E., Hutchings N., Burczyk P., Reid J., 2013. An assessment of the variation of manure nitrogen efficiency throughout Europe and an appraisal of means to increase manure-N efficiency. *Adv. Agron.* 119, 371-442.

## CARBON AND NITROGEN SEQUESTRATION AND NITRATE LEACHING MITIGATION BY COVER CROPS

GARCÍA-GONZÁLEZ, I.<sup>1</sup>, HONTORIA, C.<sup>1</sup>, GABRIEL, J.L.<sup>2</sup> ALONSO-AYUSO, M.<sup>1</sup>, QUEMADA, M.<sup>1</sup>

<sup>1</sup> Universidad Politécnica de Madrid, Spain; <sup>2</sup> INIA-INGEA-CEIGRAM, Spain

### INTRODUCTION

Integrating cover crops (CC) into crop rotations presents an opportunity to increase soil C and N sequestration and provides other important ecosystem services such as erosion control and nitrate leaching mitigation (Lal, 2015). In Mediterranean areas with low biomass production, increasing soil organic carbon (SOC) is particularly challenging. If irrigation is available, the production of biomass can be greatly increased, but the challenge of increasing SOC remains due to rapid mineralization rate. Moreover, in irrigated areas CC have been suggested as an economical approach to maintaining soil and water quality without reducing agricultural production (Gabriel et al., 2012). The objective of this work was to study the effect of replacing the traditional winter fallow by CC in crop rotations of irrigated semi-arid areas on C and N sequestration, and nitrate leaching during a 10-year period.

### MATERIAL AND METHODS

The study was conducted in the central Tajo river basin near Aranjuez (Madrid, Spain) from April 2006 to November 2016. The soil, mapped as *Haplic Calcisol*, was highly calcareous with moderate organic matter content. The field experiment consisted of a 10-year crop rotation, with or without a winter cover crop between consecutive main summer crops (maize or sunflower). The three different winter treatments were barley and vetch CC and fallow, and were replicated four times.

The cumulative biomass produced was calculated by adding the aboveground biomass of main crops at harvest and that of the CC at termination from each year. Cumulative C and N input by main crop residues and CC was also obtained for each plot.

Soil organic nitrogen (SON) and SOC were determined from the 0-5 cm and 5-20 cm horizons in samples collected at the beginning of the experiment and after harvesting the main crop every two years. At the end of the experiment, a trench was dug in each of the fallow and barley plots to obtain a profile of inorganic N distribution according to depth in the 0-4 m soil profile. The N surplus was calculated for each plot as the difference between N inputs and N exported by the crop.

### RESULTS AND DISCUSSION

The main crops produced most of the biomass, and after 2015 cumulative biomass become larger for the vetch than for the fallow treatment. The C input was larger for both CC than for the fallow treatment from March 2007 on, reaching 12 Mg ha<sup>-1</sup> in barley and 8 Mg ha<sup>-1</sup> in vetch treatments.

Soil organic C content increased with time, being larger for both CC treatments than for the fallow after 2010 (Fig. 1a). Those differences were notable only in the top 0-5 cm soil layer. The increase was equivalent to 10.7 Mg C ha<sup>-1</sup> in both CC treatments. The suppression of inverted tillage explains the increased SOC in the top layer of the fallow treatment. A similar behavior was obtained in the SON content (Fig. 1b). In the top 20 cm of soil, the rate of C sequestration in the CC treatments was 420 kg ha<sup>-1</sup> year<sup>-1</sup> and reduced to 180 kg ha<sup>-1</sup> year<sup>-1</sup> when the tillage effect was removed. The rate of N retention in the CC treatments was 38 kg N ha<sup>-1</sup> year<sup>-1</sup> and reduced to 14 kg N ha<sup>-1</sup> year<sup>-1</sup> when the tillage effect was removed.

The inorganic N content in the top 4 m of the soil profile was larger for the fallow treatment than for the barley CC (Table 1). Differences in the top 1 m were not significant but appeared in the 1 to 4 m depth, showing the

potential of barley CC to mitigate nitrate leaching. The difference in N surplus in the last four years between the barley and the fallow (62 kg N ha<sup>-1</sup>) was close to the difference in N-NO<sub>3</sub><sup>-</sup> content in the full 4 m soil profile.

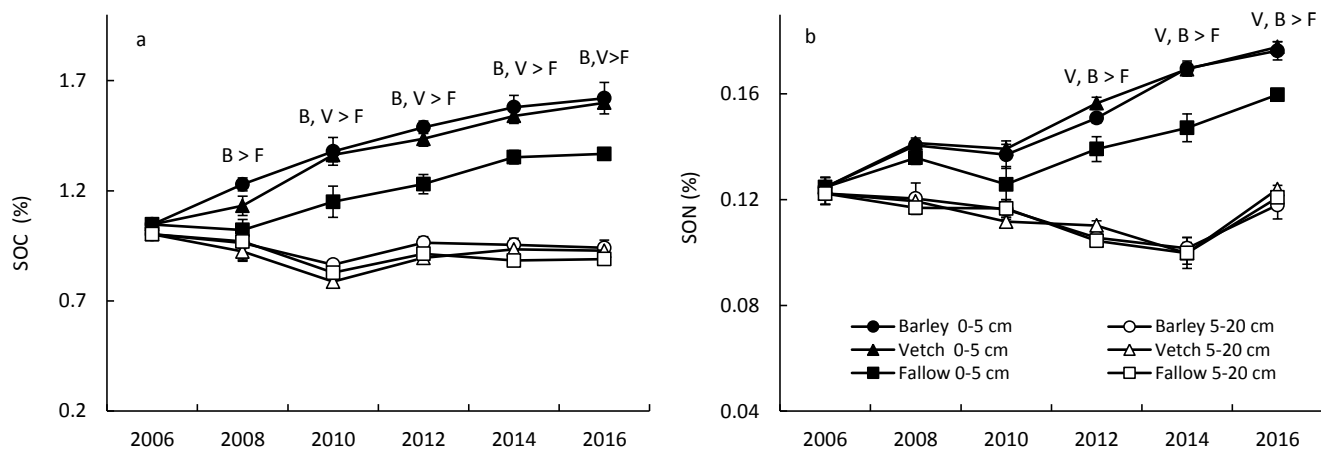

Figure 1. Temporal evolution of soil organic carbon (SOC) and soil organic nitrogen (SON) expressed as concentration (%). Significant differences between the treatments at a 0.05 probability level are indicated over each sampling time and depth by using treatment initials (B for barley, V for vetch, F for fallow).

Table 1. Soil inorganic N content distribution according to depth at the end of the experiment (2016) for the barley and fallow treatments. Different letters show significant differences between treatments and depths at a 0.05 probability level.

Depth	Soil inorganic N content (kg N ha <sup>-1</sup> )	
	Fallow	Barley
0-1 m	16.7 (6.3)	17.1 (8.4)
1-4 m	83.5 (7.8) a	38.1 (11.2) b
0-4 m	100.2 (5.8) a	55.2 (15.2) b

## CONCLUSION

Replacing the winter fallow in a crop rotation in an irrigated semi-arid area by a grass or a legume CC promoted C and N sequestration. Compared to the fallow, the soil C stocked in the 0-20 cm top layer increased by 1.6 Mg ha<sup>-1</sup> in a ten-year period, and the soil N increased by 0.12 Mg N ha<sup>-1</sup>. Adding the reduced tillage effect increased the retention rates. The capacity of barley CC to mitigate nitrate leaching was evident from the reduction in the inorganic N content in the soil profile with respect to the fallow, and the N surplus was a good indicator.

**Acknowledgements:** Spanish Ministry of Economy and Competitiveness (AGL201452310R) and Comunidad de Madrid (S2013/ABI2717). Staff of La Chimenea field Station and C. Gómez-Paccard.

## REFERENCES

- Gabriel, J.L., Muñoz-Carpena, R., Quemada, M., 2012. The role of cover crops in irrigated systems: Water balance, nitrate leaching and soil mineral nitrogen accumulation. *Agr. Ecosyst. Environ.* 155, 50-61
- Lal, R., 2015. Soil carbon sequestration and aggregation by cover cropping. *J. Soil Water Conserv.* 70, 329-339

## GRAIN YIELD AND NITROGEN USE EFFICIENCY (NUE) RESPONSE IN OLD AND NEW DURUM WHEAT GENOTYPES TO DIFFERENT FERTILIZATION TIMING

GIOACCHINI, P.<sup>1</sup>, PALUMBO, M.<sup>2</sup>, SCIACCA, F.<sup>2</sup>, VIRZÌ, N.<sup>2</sup>, ALLEGRA, M.<sup>3</sup>, ROCCUZZO, G.<sup>3</sup> CIAVATTA, C.<sup>1</sup>

<sup>1</sup> Department of Agriculture and Food Sciences, University of Bologna, Italy; <sup>2</sup> Council for Agricultural Research and Economics, Research centre for cereal and industrial crops - Acireale, Italy; <sup>3</sup> Council for Agricultural Research and Economics, Research Centre for Olive, Citrus and Tree Fruit - Acireale, Italy

### INTRODUCTION

Management of nitrogen (N) is the key for sustainable and profitable wheat production in low N soils. In order to optimize N fertilization, it is crucial to meet N availability with the period of maximum uptake by the plant, thus increasing N use efficiency of fertilizer and reducing the risk of N losses from the system. Therefore, the time of fertilization can strongly affect crop uptake of N fertilizer (Garrido-Lestache, 2005). The use of <sup>15</sup>N labelled fertilizer allows to follow this pattern in the plant-soil system and to quantify N uptake and distribution of this specific N source in the different organs of the plant. The N use efficiency (NUE) can thus be calculated more accurately. However, different genotypes of wheat can have different needs in terms of N demand, and the optimum fertilization timing might change when several genotypes are compared (Ortiz-Monasterio, 1997). In this study, the effect of three periods of N fertilizer supply was investigated on four genotypes of durum wheat in terms of production of grain, total amount of N in the grain and NUE.

### MATERIAL AND METHODS

The experiment was carried out in the 2013-2014 growing season in Sicily (37°32' N; 14°34' E; 189 m a.s.l.), in a typical area of cereals production characterized by Mediterranean climate with dry spring-summer period. The annual precipitation, about 400 mm, is concentrated in autumn and winter. The experimental design was a "split-plot" with two factors (principal factor: fertilization time; secondary factor: genotypes) with three replicates. A not fertilized control (F1) and three N fertilization timing were compared: F2 – the entire N rate at the beginning of stem elongation; F3 - 67% of N dose at the beginning of stem elongation (BBCH 30) and 33% at early boot stage (BBCH 41); F4 - the entire N rate during the stem elongation (BBCH 33). The total amount of fertilizer N was 90 kg ha<sup>-1</sup>, distributed as NH<sub>4</sub>NO<sub>3</sub>. In 3 m<sup>2</sup> subplots the fertilizer was labelled in both N atoms at 2.8 atom % of <sup>15</sup>N. The four genotypes used in the experiment have different traits: Aureo is characterized by a high gluten and protein content in the caryopsis; Iride and Simeto are high yielding and widely cultivated in the Mediterranean environment; Timilia is an old Sicilian landrace characterized by high plant and low yield. After harvest, grain yield was assessed, then grains were dried, milled and analysed for N content and isotopic composition by CF-IRMS (Continuous Flow Isotope Ratio Mass Spectrometry DeltaV Advantage Thermo Fisher Scientific) to determine the total amount of N, the N derived from fertilizer (N<sub>dff</sub>) and the NUE in the grains. Data for each trait were analyzed by STATISTICA (Statsoft Inc. 1995) and an analysis of variance (ANOVA) was conducted to test significant differences among genotypes and fertilization treatments.

### RESULTS AND DISCUSSION

The four genotypes pointed out different responses to fertilization time in terms of crop yield. The lowest grain yield (about 3 t ha<sup>-1</sup>) was obtained with the landrace Timilia. N addition never caused a significant increase of grain production with respect to the control. A similar behavior was observed also for Aureo that showed higher grain yield than Timilia (about 4.5-5 t ha<sup>-1</sup>) but no significant increase following the addition of N fertilizer, compared to the control. The highest grain yields were measured for Iride and Simeto and a significant increase in the production compared to the control was obtained with the addition of N fertilizer, in spite of the fertilization time. A similar behavior was observed for the total amount of N in the grains. Since Timilia had the lowest grain yield, this landrace also showed the lowest amount of N in the caryopsis. The other three cultivars had higher N content



compared to Timilia, but only Iride and Simeto showed a significantly higher amount of grain N in the fertilized treatments compared to the control.

The use of  $^{15}\text{N}$ -labelled fertilizer allowed to follow N derived from fertilizer in crop yield and to distinguish between the two N sources, soil and fertilizer. In the four genotypes, fertilization time affected Ndff in the grains. This content was lowest in the F2 treatment (about 20%), whereas the F3 and even more the F4 treatments caused a similar and significant increase of Ndff with values double than those of F2 treatment. Therefore, the NUE was also affected by the fertilization time, with the lowest NUE for F2 treatment with values ranging from 15% in Timilia to 27% in Simeto. The other two fertilization treatments strongly improved NUE, with F3 ranging from 35% in Timilia up to 49% in Iride; slightly higher values were measured in all the cultivars with F4 treatment. However, the landrace Timilia showed the lowest NUE in all the treatments compared to the other cultivars.

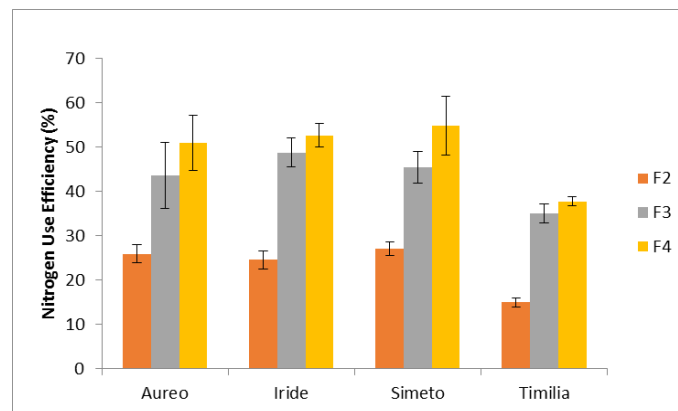

Figure 1. Nitrogen use efficiency (NUE) of the three fertilization treatments measured in the grain yield of the four genotypes. Bars are standard errors (n=3)

## CONCLUSION

Our study shows that the response of grain yield and caryopsis N content to the amount and timing of N fertilization depends on the genotype. In particular old landraces respond less than the new cultivars to N addition. However, the isotopic technique highlighted that the NUE mainly depends on the fertilization time and that the highest NUE can be obtained when the fertilizer is given during the stem elongation phase. A higher NUE also means less N remaining in soil at harvest and reduced risk of N losses from the system.

**Acknowledgements:** The authors are grateful to PON01\_01145 "ISCOCEM" Project (Sviluppo tecnologico e innovazione per la sostenibilità e competitività della cerealicoltura meridionale) for the financial support. The authors also acknowledge Stefania Licciardello and Antonio Leonardi for the valuable help provided in managing the field experiments.

## REFERENCES

- Garrido-Lestache E., Lopez-Bellido R., Lopez-Bellido L. 2005. Durum wheat quality under Mediterranean conditions as affected by N rate, timing and splitting, N form and S fertilisation. *Eur. J. Agron.* 23, 265-278.
- Ortiz-Monasterio J.I., Sayre K.D., Rajaram S., McMahon M. 1997. Genetic progress in wheat yield and nitrogen-use efficiency under four nitrogen rates. *Crop Sci.* 37, 892-898.

## DECISION RULES FOR ENVIRONMENT-FRIENDLY WHEAT N FERTILIZATION: COMBINING CROP MODEL AND VIABILITY THEORY

JEUFFROY, M.-H.<sup>1</sup>, LENOIR, A.<sup>1</sup>, RAVIER, C.<sup>1,2</sup>, SABATIER, R.<sup>3</sup>, MEYNARD, J.-M.<sup>4</sup>

<sup>1</sup> INRA UMR Agronomie, France; <sup>2</sup> Arvalis-Institut-du-végétal, France; <sup>3</sup> INRA UR Ecodéveloppement; <sup>4</sup> INRA UMR SADAPT, France

### INTRODUCTION

Current fertilization practices on wheat in France often result in low N use efficiency (NUE) and high N losses to the environment. One of the main reasons is that all existing methods and tools supporting fertilizer-N management aim at maintaining the crop in an optimal crop N nutrition status, i.e. with a Nitrogen Nutrition Index (NNI) not significantly lower than 1, during all the crop cycle. Yet, recent studies showed that some early N deficiencies do not lead to a decrease in yield or grain protein content, and even result in improved NUE (Ravier et al., 2017), and reduced N losses. Moreover, crop N demand and soil N supply, both influencing crop N uptake dynamics, are highly dependant on weather, thus questioning the current recommendations of applying N fertilizer at precise stages. To maximize crop N uptake, N application should be preferred when soil moisture is high enough, or when a rainfall is shortly following fertilizer application. Based on innovative design methods, Ravier et al. (2018) proposed to manage N applications throughout the crop cycle, based on the regular monitoring of the crop NNI (NNI-based method). Therefore, N management decision rules that favour periods of acceptable N deficiency need to be provided, to ensure high N use efficiencies and high crop performance.

### MATERIAL AND METHODS

The method was developed on one case study, in a luvisol in Normandy, and maize as preceding crop. For each of the past 20 years, the optimal days for N application were identified between the end of winter and booting stage: either a positive cumulative P-ETP in the 5 days preceding N application, or cumulative rainfall exceeding 10 mm in the three days following the application. Then, fertilization strategies were defined: each optimal day, five N rates were tested (0, 40, 60, 80, 100 kgN.ha<sup>-1</sup>). Then, the Azodyn crop model (Jeuffroy & Recous, 1999) was used to simulate NNI dynamics for each N fertilization strategy and each year. Following viability theory (Aubin, 1991), two constraints were defined to sort the simulated strategies: (i) the simulated crop NNI had to be above the minimum NNI path from tillering until flowering (defined by Ravier et al., 2017), (ii) N losses, indirectly assessed as the non-recovered fertilizer N, had to be lower than 20 kgN.ha<sup>-1</sup>. Then, robustness of each strategy was calculated, as the proportion of years for which there is at least one fertilization strategy that allows the stochastic dynamic system to match both constraints. Finally, a comparison between current recommendations and NNI-based method was implemented, based on Azodyn simulations.

### RESULTS AND DISCUSSION

For early crop stages, robustness of N fertilization strategies decreased with increased N rates, while it increased for later stages (Figure 1). Moreover, at this late stage, the lower the crop NNI, the higher the N rate with the highest robustness. For some conditions (low NNI at late stages), robustness was far from 1 (maximal value): for example, at Z31, for a plant NNI of 0.6, robustness only reached 0.5 (Figure 1), indicating that, for such a NNI level, the fertilizer rates that prevent yield losses often result in N losses outreaching 20 kgN.ha<sup>-1</sup>.

For each stage and each NNI level, the minimum N rate resulting in the maximum robustness was indicated in the table of recommended decision rules, diffused among farmers (Table 1). Applying these rules in the case study resulted in a lower mean total N rate applied than the current one, estimated by the balance sheet method (130 kgN.ha<sup>-1</sup> vs 200 kgN.ha<sup>-1</sup>). The NNI-based method resulted in a delay, between 30 and 70 days, in the first N application, compared to the current recommendation. This delay allowed to increased NUE, due to a higher crop

growth rate at the application date. Mean yields were not significantly different between the current ( $8.7 \text{ t}\cdot\text{ha}^{-1}$ ) and the NNI-based ( $8.4 \text{ t}\cdot\text{ha}^{-1}$ ) methods. The NNI-based method resulted in a strong decrease of simulated N losses (from  $55 \text{ kg N}\cdot\text{ha}^{-1}$  with current recommendations until  $5 \text{ kgN}\cdot\text{ha}^{-1}$ ). Finally, while only 50% of the cases reached 11.5% as grain protein content with the balance-sheet method, this proportion increased to 70% with the NNI-based method.

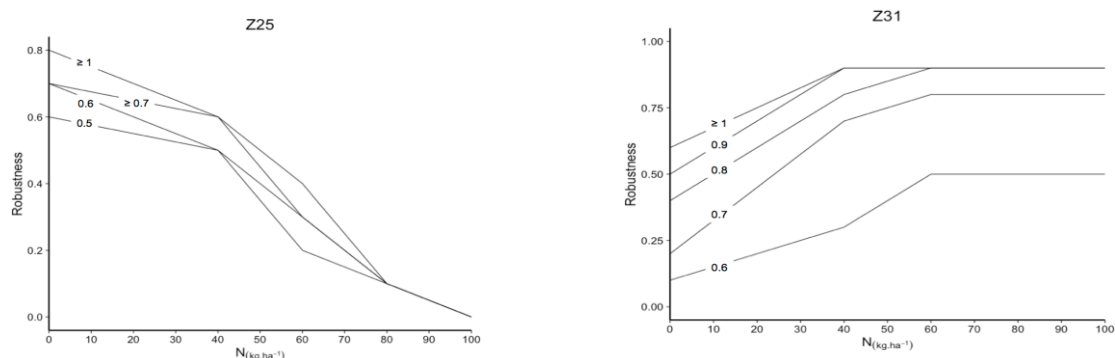

Figure 1. Robustness of the fertilizer application options (N rate) for different values of NNI (curves) for two stages, Zadoks 25 (Z25) and Zadoks 31 (Z31).

Table 1. N fertilizer rates that yielded maximum robustness while respecting both viability constraints.

Growth stages	Z25	Z29	Z31	Z32	Z37	Z40
$\leq 0.4$						
0.5	0	0				
0.6	0	0	60			
0.7	0	0	60	100		
0.8	0	0	60	80	80	40
0.9	0	0	40	60	40	40
1	0	0	40	40	40	40
$> 1.1$	0	0	40	40	0	0

## CONCLUSION

Viability theory provides an original and powerful framework, never used before for the development of a decision support system for N fertilizer management based on a soil-crop model. Field experiments are now required to analyze the ability of the NNI-based method to support farmers' change in N fertilizer management, and to confirm the high agronomic and environmental performance of this innovative method.

## REFERENCES

- Aubin J.-P., 1991. Viability Theory. Birkhäuser Boston, Boston.
- Jeuffroy M.-H., Recous S., 1999. Azodyn: a simple model simulating the date of nitrogen deficiency for decision support in wheat fertilization. *Eur. J. Agron.* 10, 129–144.
- Ravier C., Meynard J.-M., Cohan J.-P., Gate P., Jeuffroy M.-H., 2017. Early nitrogen deficiencies favor high yield, grain protein content and N use efficiency in wheat. *Eur. J. Agron.*, 89, 16-24.
- Ravier C., Jeuffroy M.-H., Gate P., Cohan J.-P., Meynard J.-M., 2018. Combining user involvement with innovative design to develop a radical new method for managing N fertilization. *Nutr. Cycl. Agroecosyst.*, 110, 117-134.

## CONSERVING CARBON STOCKS AND MITIGATING NITROUS OXIDE EMISSIONS BY USING A FORAGE CROP ROTATION INSTEAD OF CONTINUOUS MAIZE CULTIVATION

LOGES, R.<sup>1</sup>, BUNNE, I., HERMANN, A.<sup>1</sup>, TAUBE, F.<sup>1</sup>

<sup>1</sup> Grass and Forage Science / Organic Agriculture, CAU Kiel, 24118 Kiel

### INTRODUCTION

The development of mitigation strategies for climate change is one of the major environmental challenges of the 21st century. A major contributor to anthropogenic greenhouse gas (GHG) emissions is agriculture. Particularly livestock farming is responsible for roughly 12-17% of all European (EU-27) GHG emissions, with methane (CH<sub>4</sub>) emissions from enteric fermentation from ruminants being the largest contributor, accounting for 36% of these emissions (Bellarby et al., 2013). With emissions from enteric fermentation being difficult to control, two possibilities to offset GHG emissions from ruminant agriculture are increments in carbon sequestration, or reductions from nitrous oxide (N<sub>2</sub>O) emissions. Hence, this work compared a perennial system (i.e. grassland, GR), a complex annual system (i.e. crop rotation, CR) and a simple annual system (i.e. continuous maize, MA) for the development in belowground carbon stocks and the N<sub>2</sub>O emissions that resulted from these production systems.

### MATERIAL AND METHODS

The field experiment was established in the North of Kiel (N 54°27'55 E 9°57'55; 15 m a.s.l.) in autumn 2010, with measurements being conducted for ANPP and BNPP in two periods, namely between April 2012-March 2013 (P<sub>I</sub>) and April 2013-March 2014 (P<sub>II</sub>). The production systems were maintained after this time, however, to observe the long-term carbon impact by annual soil carbon measurements. Production systems included a perennial grassland (GR), a maize monoculture (MA) and a crop rotation (CR). The crop rotation consisted of grass-clover, followed by maize and winter wheat (with grass clover undersown). Each of the three production systems existed both as unfertilized treatments, as well as fertilized with 240 kg N ha<sup>-1</sup> derived from cattle slurry, with the exception of the clover-grass in the crop rotation, which was not fertilized due to the large clover share. Belowground biomass growth was analysed using the ingrowth core method, with a sampling interval of four weeks throughout the growing season and one core for the winter period. Long-term changes in the soil carbon stocks were determined using the C-model of Petersen *et al.* (2005). Carbon input in annual systems was defined as the amount of roots and stubbles that were incorporated by ploughing, while excluding potential pre-harvest losses of senesced leaves. Since no ploughing was conducted in the grassland system in addition to carbon derived by roots, a shoot turnover (leaf litter and standing dead) of 28% was assumed (from Schuman, *et al.*, 1999). Biomass production is reported as organic matter, due to the large differences in ash content particularly in the belowground biomass.

### RESULTS AND DISCUSSION

The net primary production (NPP) was comparable among production systems with mean values of 13.3 t organic matter (OM) ha<sup>-1</sup> in the grassland compared to 12.2 t OM ha<sup>-1</sup> for continuous maize and 12.7 t OM ha<sup>-1</sup> in the crop rotation. However, the harvestable aboveground biomass was lower (P < 0.01) in the grassland with 7.1 t OM ha<sup>-1</sup> compared to 9.7 t OM ha<sup>-1</sup> and 9.3 t OM ha<sup>-1</sup> for continuous maize and the crop rotation, respectively. Resulting from the year round soil cover, together with the reduced requirement for ploughing, with the complex annual system requiring ploughing only every second year due to the winter wheat cultivation with the undersown grass-clover, the effect on the soil carbon stocks increases substantially. As a result, in our model the soil carbon content after 100 years was predicted to increase by 44 t C ha<sup>-1</sup> under fertilized grassland cultivation, and by 18 t C ha<sup>-1</sup> for the unfertilized grassland, contrary to a depletion of soil carbon stocks by 7 t C ha<sup>-1</sup> or 18 t C ha<sup>-1</sup> for fertilized and unfertilized maize, respectively. The crop rotation, however, showed increments in soil carbon stocks by 3 t C ha<sup>-1</sup>, and decreased by 7 t C ha<sup>-1</sup> in the fertilized and unfertilized treatments, respectively. However, constant

management practices yield and environmental conditions are assumed, leading to potential errors in the long-term prediction, even though soil carbon measurements showed a good fit to predicted soil carbon stocks (Figure 1).

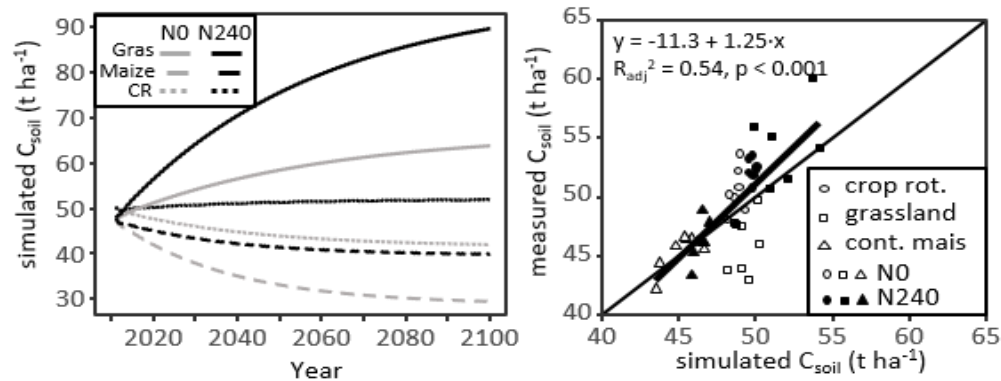

Figure 1: Modelled C stocks in soil for the Grassland (GR), continuous maize (MA) and crop rotation (CR), both without (ON) or with fertilization using cattle slurry (N240). Model validation was performed using soil C measurements from 2011-2017.

Biological N fixation was high, independent of the N-fertilization, particularly in the first experimental year, with  $202 \text{ kg N ha}^{-1}$  in the grassland, and  $234 \text{ kg N ha}^{-1}$  in the grass clover stand of the crop rotation. However, while the grass-clover system even increased the N-fixation to  $324 \text{ kg N ha}^{-1}$  in the second experimental year, the grassland reduced its potential to  $67 \text{ kg N ha}^{-1}$ , due to the decreased clover share. Cumulative nitrous oxide emissions were generally lowest in the grassland, with on average  $0.7$  and  $0.8 \text{ kg N}_2\text{O ha}^{-1} \text{ a}^{-1}$  for the unfertilized and fertilized grassland, respectively. This compared favorably to both the crop rotation, with  $2.6$  and  $3.9 \text{ kg N}_2\text{O ha}^{-1} \text{ a}^{-1}$  or the continuous maize, with  $3.0$  and  $3.9 \text{ kg N}_2\text{O ha}^{-1} \text{ a}^{-1}$ , for unfertilized and fertilized treatments, respectively. However, despite the  $\text{N}_2\text{O}$  emissions being equal between the crop rotation and the continuous maize, the crop rotation would have lower overall emissions, due to the biological nitrogen fixation, which results in lower mineral fertilizer inputs, as well as due to the higher carbon inputs.

## CONCLUSION

The grassland resulted in higher carbon inputs and lower nitrous oxide emissions, thus making it the best solution from a climate smart agriculture perspective. The crop rotation, however, managed to obtain comparable harvestable biomass to the continuous maize, while having an improved impact on the soil carbon content relative to the continuous maize and the additional benefit of the biological nitrogen fixation.

**Acknowledgements:** These investigations were supported by the European Commission (Project ID: 289328, Funded under: FP7-KBBE, CANTOGETHER (Crops and ANimals TOGETHER) project).

## REFERENCES

- Bellarby, J., Tirado, R., Leip, A., Weiss, F., Lesschen, J.P., and Smith, P. (2013). Livestock greenhouse gas emissions and mitigation potential in Europe. *Global Change Biol* 19, 3-18.
- Petersen, B.M., Berntsen, J., Hansen, S., and Jensen, L.S. (2005). CN-SIM—a model for the turnover of soil organic matter. I. Long-term carbon and radiocarbon development. *Soil Biology and Biochemistry* 37, 359-374.
- Schuman, G.E., Reeder, J.D., Manley, J.T., Hart, R.H., and Manley, W.A. (1999). Impact of grazing management on the carbon and nitrogen balance of a mixed-grass rangeland. *Ecological Applications* 9, 65-71.

# 20<sup>th</sup> Nitrogen Workshop

## Coupling C-N-P-S cycles

June 25-27, 2018  
Le Couvent des Jacobins, Rennes – France

### **Session IV: Studies and mitigation options at the farm level Posters**

## A SPATIAL FRAMEWORK TO FACILITATE TESTING AND ADOPTION OF NEW TECHNOLOGIES

GRASSINI, P, RATTALINO EDREIRA, JI, CASSMAN, KG

University of Nebraska-Lincoln, NE, USA

### INTRODUCTION

Ensuring adequate food production in systems that protect environmental quality and conserve natural resources requires acceleration in the rate of crop yield gains on existing farmland. Meeting this challenge will be difficult without a robust spatial framework that facilitates rapid evaluation and adoption of currently available and emerging technologies. Here we developed a global spatial framework to delineate ‘technology extrapolation domains’ (TEDs) based on key climate and soil factors that govern crop yields and stability.

### MATERIALS AND METHODS

The spatial framework we delineated utilizes four biophysical factors to delineate TEDs: (i) annual total growing degree-days, which in large part determines length of time during the year that crop growth is not limited by cold temperature; (ii) aridity index, which largely defines the degree of water limitation in rainfed cropping systems; (iii) annual temperature seasonality, which differentiates between temperate and tropical climates; (iv) and plant-available water holding capacity (PAWHC), which determines the capacity of a soil to store water to support crop growth during rain-free periods. We assessed the robustness of the TEDs by evaluating average yields and temporal yield variability (quantified with the coefficient of variation, CV) of maize across the US Corn Belt under the hypothesis that a robust spatial framework will adequately represent yield differences across a wide range of climate and soil types. Average yield and CV were evaluated across a group of selected counties in two dimensions: (i) a transect with different climate but with similar PAWHC, and (ii) a transect with soils with different PAWHC within the same climate. We demonstrated applications of the TEDs by showing how to maximize coverage of crop production with a minimum number of testing locations for an existing field trail network conducted to evaluate a product that improves nitrogen (N) fertilizer use efficiency of maize.

### RESULTS AND DISCUSSION

Results showed that differences in average yields and CVs varied in a manner consistent with expectations due to climate and soil type. For example, counties with similar PAWHC but located in different climates exhibited significant differences in average yield and CV across two directional transects in the US north-central region. In the NW-SE direction, both average yield and yield stability increased towards the SE due to longer growing season and smaller aridity index (i.e., greater water supply). In the SW-NE direction, yields and yield stability likewise increase due to smaller aridity index. Similarly, counties located in the same climate, but with different PAWHC, exhibited increasing yields and decreasing CVs in TEDs with greater PAWHC. These results suggest that the TED scheme is robust for capturing the influence of key biophysical factors on crop yields and its variability and, by extension, to also capture differences in crop response to management practices that depend on amount and reliability of water supply and length of growing season.

Given the high cost of time and labor to implement replicated field studies in commercial production fields, the TED framework presented here can help (i) optimize the number of environments covered by a field trial to maximize the crop area coverage in unique TEDs for a given number of sites or, alternatively, to reduce the number of sites without sacrificing crop area coverage in unique TEDs, (ii) select specific environments for testing a technology where it is most likely to have the greatest impact based on biophysical attributes of the selected TEDs, (iii) delineate the extrapolation domain for specific field trials, allowing up-scaling of expected impact from trial locations to TEDs in which the trials were conducted, and (iv) facilitate technology transfer across analog TEDs located in different geographic regions. Potential to improve efficiency of a field testing program is illustrated in Figure 1. The curvilinear line represents the crop production area coverage for a given number of field trials if each

site is located in a unique TED, starting from the origin with TEDs that include largest crop production area to those with smallest area to the right (**Fig. 1A**). Hence, any set of field experiments can be compared against this ‘efficiency frontier’ line to identify opportunities for greater coverage of crop area within unique TEDs. To illustrate this point, we evaluate maize area coverage by a set of 96 field experiments conducted in 2015 and established in farmer fields to evaluate a product thought to improve nitrogen fertilizer efficiency of maize. The 96 sites were located within 19 TEDs (**Fig. 1B**) which accounted for 42% of total US maize area. In contrast, strategic reallocation of each field experiment in a unique TED with greatest crop area would achieve the same coverage with only 11 field studies (**Fig. 1C**), or double the coverage if each of the 96 trials would be reallocated in a unique TED (**Fig. 1D**).

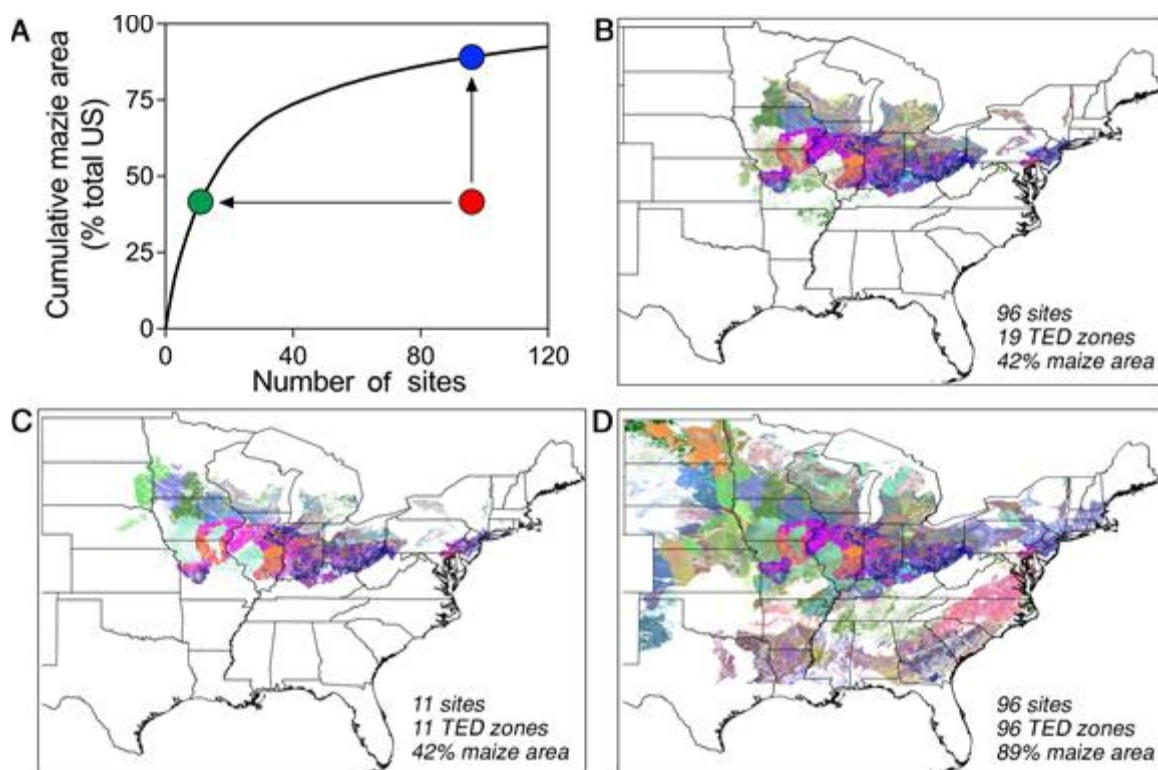

**Figure 1.**

*Strategic location of field experiments to maximize coverage of unique TEDs based on a network of 96 experiments conducted in 2015 and located in farmers’ fields to evaluate a product that improves N fertilizer use efficiency of maize. Each color in the maps represents a unique TED. (A) The efficiency frontier shown by the curvilinear line representing maximum maize crop area coverage for a given number of sites if each experiment was allocated in a unique TED unit, starting from the TED with largest crop area on the left and sequentially smaller crop area to the right. Mapping the 96 sites showed that many were located in the same TED such that only 19 unique TEDs and 42% of total maize area was covered as indicated by the red dot in (A). TEDs in which field trials were located are shown in (B). Strategic placement of field experiments such that each was located in a unique TED reduces the number of trials by 90% to give the same crop area coverage within unique TEDs as shown in (C) and the green dot in (A), while the same number of field experiments would more than double the crop area coverage as shown in (D) and the blue dot in panel (A).*

## CONCLUSION

Results from evaluation of the TED framework presented here show promise for capturing effects of dominant climate and soil factors responsible for variation in rainfed crop yields, and for facilitating greater efficiency in testing of new technologies and gaining adoption of those that improve yields, yield stability, profits and reduce negative environmental impact through delineating the area where they are likely to work best.

## REFERENCES



Rattalino Edreira JI, Cassman KG, Hochman Z, van Ittersum MK, van Bussel L, Claessens L, Grassini P (2018) Beyond the plot: Technology extrapolation domains for scaling out agronomic science. Environmental Research Letters 13, 054027. An online version of the TEDs is available at: <http://nutrientstar.org/ted-framework/>

## SHADE TREE SPECIES IMPACTS ON SOIL FAUNA AND C, N, P CYCLES IN COSTA RICAN ORGANIC AND CONVENTIONAL COFFEE AGROFORESTRY SYSTEMS

SAUVADET, M.<sup>1</sup>, VAN DEN MEERSCHE, K.<sup>2,3</sup>, ALLINNE, C.<sup>3,4</sup>, GAY, F.<sup>2,3</sup>, VIRGINIO FILHO, E.DE.M.<sup>3</sup>, CHAUVAT, M.<sup>5</sup>, BECQUER, T.<sup>1</sup>, TIXIER, P.<sup>6</sup>, HARMAND, J-M.<sup>2,7</sup>

<sup>1</sup> IRD, UMR Eco&Sols, France; <sup>2</sup> CIRAD, UMR Eco&Sols, France; <sup>3</sup> CATIE, Costa Rica; <sup>4</sup> CIRAD, UMR System, France; <sup>5</sup> Université de Normandie, Ecodiv, France; <sup>6</sup> CIRAD, UPR Geco, France; <sup>7</sup> ICRAF, Cameroon

### INTRODUCTION

Coffee is a major export product for developing countries that provides the livelihoods of tens millions of people (Pendergrast, 2009). Coffee is traditionally grown under shade trees to decrease physiological stress and provide additional services to the farmers as food or material supply (fruit trees, timber trees) (Tscharntke et al., 2011). However, agricultural intensification in Central America led to conversion of shaded to unshaded coffee systems to increase short-term income, but may have direct consequences on soil biological fertility (Perfecto et al., 2007). An important stake nowadays is to find the right compromise between decent yields and synthetic inputs reduction through promotion of soil biological activity.

Our objective was thus to determine how two common shade trees in coffee agrosystems, *Terminalia amazonia* and *Erythrina poeppigiana*, would impact on soil C, N, P cycling in association with soil fauna.

### MATERIAL AND METHODS

We worked in an experimental site from Turrialba (Costa Rica), where various management levels and shade tree associations in coffee plantation were continuously compared since 2000 (Haggar et al., 2011). We compared in August 2017 soil fertility from two management levels (organic and conventional, Table 1), both management being declined in three shade trees association: unshaded, shaded by *Terminalia amazonia* (timber tree), shaded by *Erythrina poeppigiana* (N<sub>2</sub>-fixing service tree).

Table 1: Organic and conventional system annual management.

	Organic	Conventional
Fertilization	5 t ha <sup>-1</sup> coffee pulp: 66 kg N ha <sup>-1</sup> , 2 kg P ha <sup>-1</sup> , 44 kg K ha <sup>-1</sup>	Mineral fertilizers: 150 kg N ha <sup>-1</sup> , 10 kg P ha <sup>-1</sup> , 75 kg K ha <sup>-1</sup>
Phytosanitary Control	Regular mowing	5 Herbicides applications 1-4 fungicides/insecticides as required

Total C, total N, inorganic N and Olsen P contents, along with pH (H<sub>2</sub>O) were analyzed on the top soil layer (0-10 cm) in August 2017. A bioassay (biomass production of maize in pots for 45 days) was done from each combination of management and shade trees associations. Soil nematodes and microarthropods communities were extracted, counted, identified and separated into functional groups.

### RESULTS AND DISCUSSION

Shade tree impacts on soil fertility depended on tree- species. The association with *Erythrina* increased soil inorganic N content and bioassay (Fig. 1a), but not Olsen P. *Terminalia* impacts depended more on the system management. Moreover, association with shade trees had higher impacts on soil fauna than on soil fertility, with a large increase of its density and diversity compared to the unshaded systems excepted under *Terminalia* in organic system (Fig. 1b). *Erythrina* had higher positive effects on soil fauna (both for density and diversity) than *Terminalia*. Specific relationships between soil community structure and soil fertility were studied in this work and

showed positive correlation of nematodes functional groups with soil inorganic N content, while soil Olsen P was more linked to detritivores diversity.

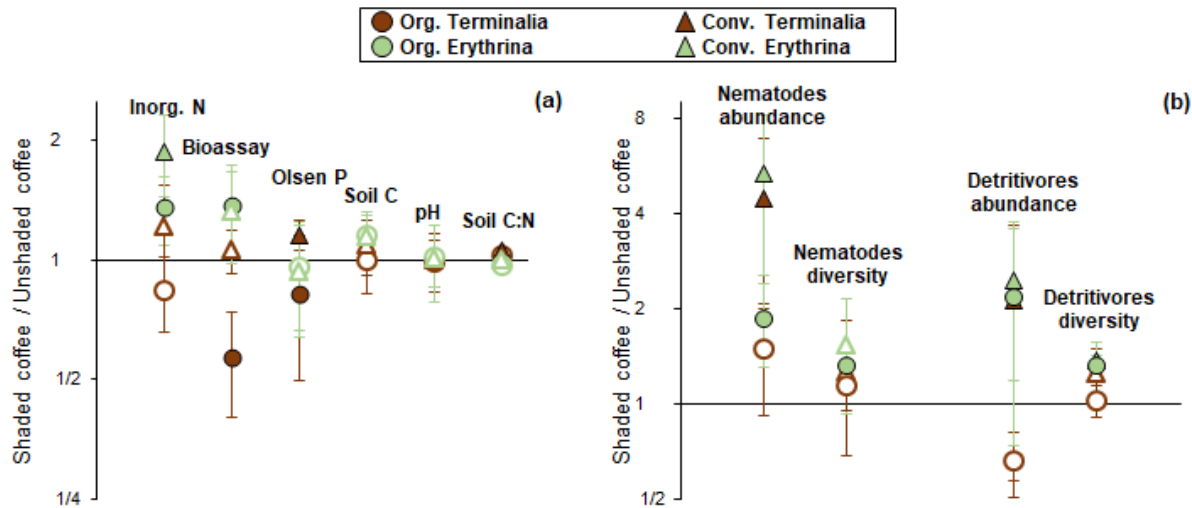

Figure 1. Shade tree impacts on soil fertility (a) and fauna (b). Non-significant data ( $P$ -Value > 0.05) were tested by ANOVAs and are represented with hollow symbols. Fauna diversity was represented with Shannon index calculated at respectively the genera (nematodes) and morphotype (detritivores) levels. Ratios between shaded and unshaded coffee are represented in the Y-axis with a log-2 scale. Detritivores: collembola and oribatid mites.

## CONCLUSION

Our results underscore the importance of associated shade trees in soil biological properties and in fertility of coffee systems. Part of the shade tree impacts on soil fertility were balanced by fertilizers addition in the conventional system, yet soil fauna mirrored well soil biogeochemical changes in both systems, underlining the potential of using fauna functional groups as indicators of soil biological fertility.

**Acknowledgements:** The present work was funded by Agropolis foundation with STRADIV project (n° 1504-003). The authors thank Victor Hugo Mendez Sanabria, Patricia Leandro, Nancy Rakotondrazafy, Najat Talha, Jean Larvy-Delarivière and Jean-Marc Souquet for their help with soil sampling and analyses.

## REFERENCES

- Haggar, J., Barrios, M., Bolaños, M., Merlo, M., Moraga, P., Munguia, R., Ponce, A., Romero, S., Soto, G., Staver, C., Virginio, E. de M.F., 2011. Coffee agroecosystem performance under full sun, shade, conventional and organic management regimes in Central America. *Agroforestry Systems* 82, 285–301.
- Pendergrast, M., 2009. Coffee second only to oil? Is coffee really the second largest commodity? *Tea & Coffee Trade Journal*.
- Perfecto, I., Armbrecht, I., Philpott, S.M., Soto-Pinto, L., Dietsch, T.V., 2007. Shaded coffee and the stability of rainforest margins in northern Latin America. In: *Stability of Tropical Rainforest Margins*, Environmental Science and Engineering. Springer, Berlin, Heidelberg, pp. 225–261.
- Tscharntke, T., Clough, Y., Bhagwat, S.A., Buchori, D., Faust, H., Hertel, D., Hölscher, D., Jührbandt, J., Kessler, M., Perfecto, I., Scherber, C., Schroth, G., Veldkamp, E., Wanger, T.C., 2011. Multifunctional shade-tree management in tropical agroforestry landscapes – a review. *Journal of Applied Ecology* 48, 619–629.

## N FERTILIZER VALUE OF LEGUME-BASED CATCH CROPS

DE NOTARIS, C.<sup>1</sup>, SØRENSEN, P.<sup>1</sup>, RASMUSSEN, J.<sup>1</sup>, OLESEN, J. E.<sup>1</sup>

<sup>1</sup> Department of Agroecology, Aarhus University, Blichers Allé 20, Tjele, Denmark

### INTRODUCTION

N availability is one of the main factors limiting productivity in organic arable systems (Olesen et al., 2007). Legume-based catch crops (CC) were shown to both increase main crop N yield and reduce N leaching at the crop rotation scale, but management strategies are required to stabilize their growth, such as early undersowing and a reduced competition with the main crop (De Notaris et al., 2018). The present study aims to investigate the effect of main crop manure application and row space, and CC sowing time on N accumulation in undersown CC biomass and their fertilizer value (the amount of mineral N that can be replaced) for the subsequent crop.

### MATERIAL AND METHODS

#### N fertilizer replacement value (NFRV) experiment

A CC mixture of red clover, white clover, ryegrass and chicory (commonly used by organic farmers in Denmark) was undersown in organically managed spring wheat in 2015 and 2016 at Foulumgaard Experimental Station (56° 30'N, 9° 34' E), Denmark. Three treatment factors were tested, within a fully randomized factorial design with 4 replicates: main crop manure application (with and without) and row space (12, 18 and 24 cm), and CC sowing (early May, late May and no CC). CC above- and below-ground (20 cm depth) samples were taken in late October to determine dry matter and N content. In March of the following years (2016 and 2017), the plots were harrowed (CC termination) and, 10 days later, CC biomass was incorporated in the soil by ploughing. In April, oat was sown to test the N fertilizer replacement value (NFRV) of the CC. NFRV indicates to how many kg N fertilizer ha<sup>-1</sup> corresponded the effect of the CC. Plots that had CC in the previous year did not receive any fertilization. The others were fertilized with mineral fertilizer (NS 27-4) to a rate of 0, 40 or 80 kg N ha<sup>-1</sup>, to establish oat grain N yield mineral N response curves. Regression coefficients of the response curves (separately for 2016 and 2017, without and with manure) were used to calculate the NFRV of CC (Jensen, 2013).

Statistical analyses were performed using R (R Core Team, 2016). Analysis of variance (ANOVA) tests were performed to assess the effect of main crop manure and row space, and CC sowing time on CC N and NFRV in 2015 and 2016. The assumptions of normality and homoscedasticity were checked with the Shapiro-Wilk test and visual examination of the residuals against fitted values. For all statistical tests  $\alpha=0.05$ .

### RESULTS AND DISCUSSION

#### N in catch crops biomass and NFRV in the following year

In 2015, N harvested in CC biomass (above- plus below-ground) was significantly affected by manure application ( $p<0.001$ ) and by the interactions: manure-row space ( $p<0.01$ ) and manure-sowing time ( $p<0.05$ ). In particular, manure reduced CC biomass (and thus CC N), but early sowing and increased row space counteracted the reduction (Table 1). The NFRV in the following year (2016), measured on oat grain N yield, was on average 25 kg N ha<sup>-1</sup>. It was significantly higher in treatments with no manure in 2015 ( $p<0.01$ ) and early sowing of CC ( $p<0.01$ ), but no interaction among factors could be detected. In 2016, N accumulated in CC biomass was only significantly affected by manure application ( $p<0.001$ ). The average NFRV in the following year (2017) was 43 kg N ha<sup>-1</sup>, in the range of the highest NFRV values in 2016, with no significant difference among treatments.

N accumulated in CC biomass was positively affected by early sowing and an increased row space when the growing conditions for the CC were not favorable, like in 2015. This effect was not visible in 2016, when CC growth

was not limited. N accumulated in CC biomass varied from a minimum of 15 kg N ha<sup>-1</sup> in 2015 to a maximum of 133 kg N ha<sup>-1</sup> in 2016, whereas NFRV varied from 10 to 50 kg N ha<sup>-1</sup>. This indicates how the residual effect of CC is not solely determined by N accumulation in their biomass, whose variations were not always reflected in the NFRV.

*Table 1. N accumulated in CC biomass (above- plus below-ground; Catch Crop N) and N Fertilizer Replacement Value (NFRV) in the following year (kg N ha<sup>-1</sup>) by different manure application and row space in the first-year main crop and by different sowing time of the CC. Data shown are average values (n=4). M= with manure; NM= no manure.*

Previous year treatment			2015-16		2016-17	
Catch crop sowing	Manure	Space (cm)	Catch Crop N	NFRV	Catch Crop N	NFRV
Early May	M	12	25	21	99	49
		18	65	16	100	44
		24	47	22	102	46
	NM	12	98	50	122	35
		18	74	48	115	45
		24	102	31	133	34
Late May	M	12	15	19	91	45
		18	24	10	88	39
		24	30	12	82	49
	NM	12	108	13	109	43
		18	85	24	126	40
		24	102	29	116	46

## CONCLUSION

Early CC sowing time and an increased main crop row space can help stabilize CC growth and increase N accumulation, especially when the conditions for the CC are not favorable. Despite the variations in N accumulated in CC biomass, legume-based catch crops represent a valuable source of N for the subsequent crop, with their fertilizer value being less variable than the N accumulated in CC biomass.

**Acknowledgements:** We thank Erling Nielsen for his technical support. The study was part of the RowCrop project funded under Organic RDD2 by the Danish Ministry of Environment and Food.

## REFERENCES

- de Notaris, C., Rasmussen, J., Sørensen, P. & Olesen, J. E. 2018. Nitrogen leaching: A crop rotation perspective on the effect of N surplus, field management and use of catch crops. *Agriculture, Ecosystems & Environment*, 255, 1-11.
- Jensen, L. S. 2013. Animal Manure Fertiliser Value, Crop Utilisation and Soil Quality Impacts. *Animal Manure Recycling*. John Wiley & Sons, Ltd.
- Olesen, J. E., HANSEN, E. M., ASKEGAARD, M. & RASMUSSEN, I. A. 2007. The value of catch crops and organic manures for spring barley in organic arable farming. *Field Crops Research*, 100, 168-178.
- R CORE TEAM 2016. R: A language and environment for statistical computing. R Foundation for Statistical Computing, Vienna, Austria. URL <https://www.R-project.org/>.

## **MORE PROFIT FROM NITROGEN IN AUSTRALIAN AGRICULTURE**

SMITH, A. P.<sup>1</sup>, WHITE, M.<sup>2</sup>

<sup>1</sup> University of Melbourne; <sup>2</sup> ICD Project Services, Australia

### **INTRODUCTION**

Many Australian soils are low in organic matter and nutrient deficiency is widespread therefore regular fertilization is often required to lift the productivity of many crops and pastures. Given the potential risk of reduced yields from insufficient N, coupled with the relatively-low unit cost of N fertilizer, producers in high rainfall or irrigated regions generally err on the side of over-applying N fertiliser. In drier or regions with higher climate variability, the higher production risks mean farmers may tend to under fertilise to manage financial risks. The result is poor nitrogen use efficiency (NUE) being common across agricultural industries.

Over many decades, much research in Australia has been conducted on the N requirements and management for a range of agricultural systems. The potential to improve the NUE of many modern farming systems, declining terms of trade and increasing pressure to reduce agricultural greenhouse gas emissions, means that ongoing N research remains essential. Improving NUE and balancing the productivity and environmental impacts of N use are increasing imperatives for Australian agriculture.

A new national research program in Australia called 'More Profit from Nitrogen' (MPfN) draws on a multi-institutional and cross industry unified effort to address these imperatives. MPfN is a proactive industry based initiative to improve NUE to reduce environmental impact and increase the long-term sustainability of Australian farming businesses by increasing yield, quality product and overall profitability. The agricultural industries involved in the MPfN Program share common markets that are increasingly requiring evidence of sustainability credentials of the products they produce.

### **MATERIAL AND METHODS**

MPfN is a AUD \$15.6M, 4-year program jointly funded by the Australian government through its Rural Research and Development for Profit program, each of the participating industry Rural Research & Development Corporations<sup>1</sup>, and the project research partners. This industry-led program aims to bring about increased farm profitability and reduced environmental impact by increasing NUE across the Australia's four major intensive users of nitrogenous fertilizers: cotton, dairy, sugar and horticulture. This will be achieved by generating a greater knowledge and understanding of

- the interplay of factors to optimise N formulation, rate and timing across industries, farming regions and irrigated/ non-irrigated situations;
- the contribution of mineralisation to a crop or pasture's nitrogen budget; and
- matching the formulation of enhanced efficiency fertilizers (EEF) formulations with crop or pasture's specific N requirements.

---

<sup>1</sup> Cotton Research & Development Corporation, Dairy Australia, Sugar Research Australia and Hort Innovation

## RESULTS AND DISCUSSION

Ten research projects are being delivered under the MPfN program through 23 collaborating partners. The ten projects are producing outcomes which will inform new N fertilizer formulations, application and measurement technologies, decision support tools and industry best practice guidelines. A total of 35 field based experiments have been established in the first eighteen months in various climate zones (see Figure 1). This in-field research is supported by laboratory experimentation, analysis, simulation and biophysical modelling.

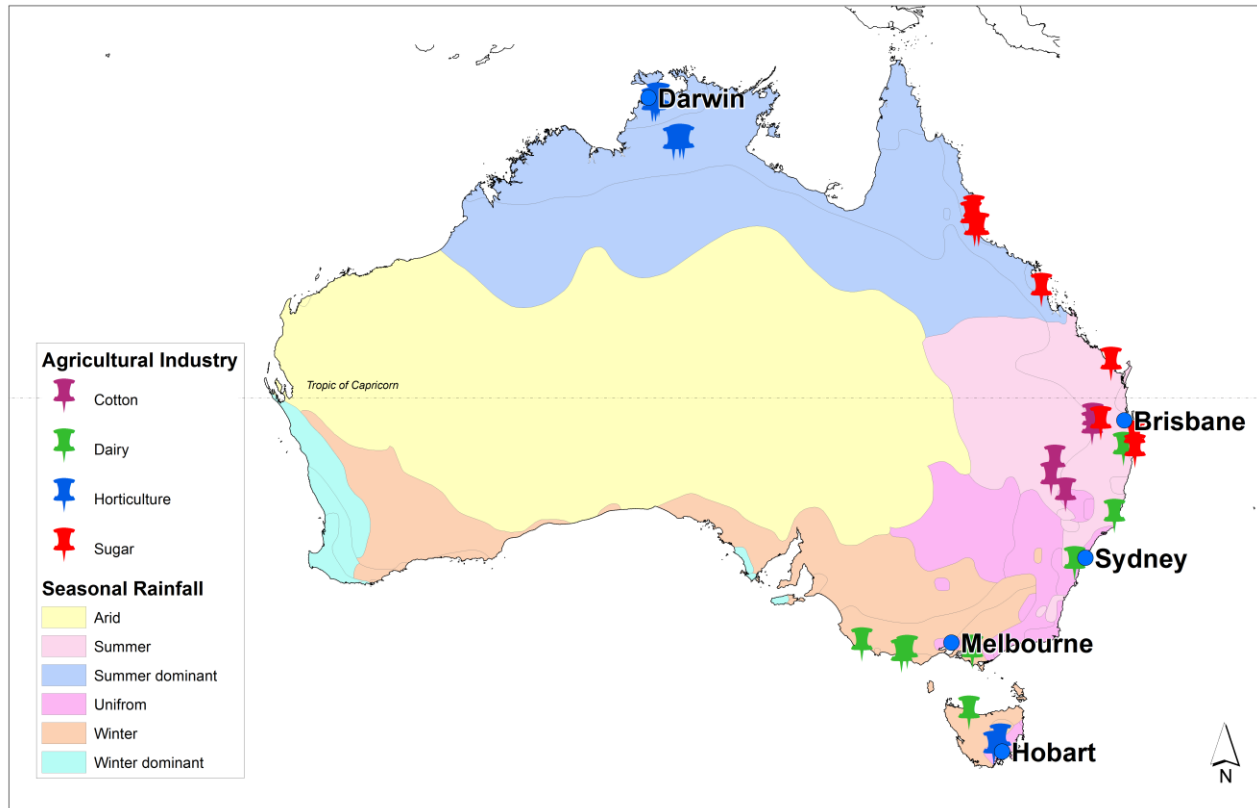

Figure 1. Locations of MPfN study sites based on agricultural industry in the different rainfall regions of Australia.

MPfN is providing a platform for cross industry collaboration on N management, the results of which is fostering unprecedented information and knowledge exchange amongst Australia's leading scientists. It is also extending research outputs to producers, leading to N best management practice adoption.

## CONCLUSION

MPfN is a proactive industry based initiative to improve NUE to reduce environmental impact and increase the long-term sustainability of Australian farming businesses by increasing yield, product quality and overall profitability. Through collaboration, the MPfN program outcomes will provide the agricultural industries involved with much needed evidence of their continuously improving performance in the pursuit of quality food and fibre production with the lowest possible environmental impact. Since commencing in 2016, the MPfN Program has already been produced information and early results which will be of widespread interest.

## BENCHMARKING ON-FARM N FOOTPRINT USING A SIMPLIFIED N-BALANCE APPROACH

TENORIO, F.A.<sup>1</sup>, MCLELLAN, E.<sup>2</sup>, EAGLE, A.<sup>2</sup>, GRASSINI, P.<sup>1</sup>

University of Nebraska-Lincoln, Nebraska, USA; <sup>2</sup>Environmental Defense Fund, Washington, D.C., USA

### INTRODUCTION

Achieving further increases in grain production will require greater nitrogen (N) uptake by crops. However, N fertilizer application can negatively impact environmental quality if not properly utilized. Meeting both productivity and environmental goals requires fine-tuning the application of external N inputs relative to crop N requirements. A number of studies have shown that magnitude of N losses is associated with the soil N-balance, that is, the difference between N inputs and harvested grain N. In other words, the magnitude of N surplus can be taken as an indicator of potential N losses. The 'N-balance' approach offers a practical way to benchmark N input use in farmer fields. Despite these potential applications, the potential of using the N-balance as a metric to benchmark and monitor N footprint across large agricultural areas remains unexploited. The goal of this study was to develop a simple N-balance method for benchmarking on-farm N use and provide proof of concept using irrigated and rainfed maize in Nebraska (USA) as a study case.

### MATERIALS AND METHODS

The framework developed here was intended to be simple, robust, and to only require a few, easily retrievable data inputs. As previously mentioned, estimation of N-balance requires information about amount of N inputs and crop N uptake. In our framework, N inputs were calculated as the sum of N applications from fertilizer and manure. In contrast to N inputs, farmers rarely record crop N uptake. Fortunately, farmers keep yield records; hence, N uptake can be estimated based on yield, assuming a constant maize grain N concentration (assumed to be 1.14% based on literature review). Our approach assumes steady state for indigenous soil N (*i.e.*, no net change over time) and that other external sources of N (*e.g.*, deposition, irrigation water) are relatively small.

This simplified N-balance is conceptually robust as (i) it accounts for major components of the N-balance in agro-ecosystems (*i.e.*, N inputs and crop N uptake), (ii) it requires a small number of data inputs for its calculation, and (iii) a small positive N-balance can be used as an attainable benchmark for farmers seeking to maximize yields and minimize N footprint. Ideally, a small positive N-balance reduces potential N losses, while maximizing yield and maintaining soil quality over time. A negative N-balance (*i.e.*, N deficit) indicates that crop N removal exceeds N replenished through fertilizer and manure inputs; hence, if this trend persists over time, there will be progressive soil mining and declining crop productivity. In contrast, a large positive N-balance (*i.e.*, N surplus) indicates that N inputs exceed crop N removal, leading to high potential N losses. In other words, a large environmental footprint associated with N inputs in agro-ecosystem is expected when too much N input is applied in relation with crop N demand.

We provided proof of concept using maize in eastern Nebraska (USA) as a study case. Farmer-reported data were available from rainfed and irrigated fields sown with maize during 2004-2015; fields were located within the same soil-climate domain. The database contained a total of 2,468 field-year observations and associated data on yield and N fertilizer rates. We calculated N-balance for each field using farmer-reported yield and N fertilizer rate. Partial factor productivity for N fertilizer (PFP<sub>N</sub>) was calculated as the yield-to-N fertilizer ratio. We evaluated the influence of water regime (irrigated versus rainfed), previous crop (maize grown after soybean *versus* maize after maize), and their interaction on yield, N-balance, PFP<sub>N</sub>, and N-balance per yield using ANOVA. LSD test was used to determine statistically significant differences ( $\alpha=0.05$ ) between water regimes x previous crop combinations.



## RESULTS AND DISCUSSION

Average on-farm irrigated and rainfed maize yield was 12.7 and 8.4 Mg ha<sup>-1</sup>, respectively (**Table 1**). These yields corresponded to ca. 85 and 75% of average yield potential estimated for irrigated (14.8 Mg ha<sup>-1</sup>) and rainfed maize (11.2 Mg ha<sup>-1</sup>) in eastern Nebraska ([www.yieldgap.org](http://www.yieldgap.org)). As a result of erratic rainfall, average rainfed yield was highly variable, as indicated by its high inter-annual coefficients of variation (CVs), which was 4x larger than for irrigated maize. Average N fertilizer rate was 50% higher in irrigated *versus* rainfed fields and 10% higher in fields sown with maize after maize *versus* maize after soybean ( $P<0.01$ ) (**Table 1**). There was a statistically significant interaction between water regime and previous crop on N-balance, with the latter ranging from 58 kg N ha<sup>-1</sup> (irrigated maize after maize) to 26 kg N ha<sup>-1</sup> (rainfed maize after soybean). Average N-balance was ca. 5x more stable in irrigated *versus* rainfed maize (CVs= 24-32 versus 106-126%), indicating a strong year x water regime interaction influencing the N-balance ( $P<0.01$ ). Despite higher N fertilizer rate, irrigated maize after soybean exhibited similar N-balance and PFP<sub>N</sub> as rainfed crops, with much higher and stable yields and lower N-balance per yield (**Table 1**).

**Table 1.** Average yield, nitrogen (N) fertilizer, N-balance, partial factor productivity for N fertilizer (PFP<sub>N</sub>; yield-to-N fertilizer ratio), and N-balance per yield for irrigated and rainfed maize fields sown after maize or soybean. Parenthetic values indicate the inter-annual coefficient of variation (in %). Yields and PFP<sub>N</sub> were expressed at 15.5% grain moisture content.

Water regime	Previous crop	Yield (Mg ha <sup>-1</sup> )	N fertilizer (kg N ha <sup>-1</sup> )	N-balance (kg N ha <sup>-1</sup> )	PFP <sub>N</sub> (kg grain kg <sup>-1</sup> N)	N-balance/yield (kg N Mg <sup>-1</sup> grain)
Irrigated	maize	12.5 (5) <sup>a</sup>	201 (8) <sup>a</sup>	58 (24) <sup>a</sup>	63 (7) <sup>b</sup>	4.6 (24) <sup>ab</sup>
	soybean	12.8 (7) <sup>a</sup>	182 (8) <sup>b</sup>	36 (32) <sup>b</sup>	71 (7) <sup>a</sup>	2.8 (34) <sup>b</sup>
Rainfed	maize	8.7 (24) <sup>b</sup>	130 (17) <sup>c</sup>	31 (126) <sup>b</sup>	69 (36) <sup>ab</sup>	4.8 (149) <sup>ab</sup>
	soybean	8.0 (29) <sup>c</sup>	118 (17) <sup>d</sup>	26 (106) <sup>b</sup>	70 (33) <sup>a</sup>	5.4 (176) <sup>a</sup>

\*DIFFERENT LETTERS INDICATE STATISTICALLY SIGNIFICANT ( $P<0.05$ ) DIFFERENCES BETWEEN WATER REGIME X PREVIOUS CROP COMBINATIONS.

Annual regional averages masked variation in yield and N-balance across farmer fields (**Figure 1**). Based on Grassini *et al* (2012), we identified fields with large N surplus as those with N-balance  $\geq 50$  kg N ha<sup>-1</sup>. Based on this categorization, ca. 53 and 27% of irrigated and rainfed maize fields exhibited a large N surplus (**Figure 1**). We found a statistically significant linear relationship between yield and N-balance for all water regime x previous crop combinations ( $P<0.01$ ). Consistent with this observation, ca. 40% and 70% of irrigated and rainfed maize fields, respectively, exhibited above-average yields with N-balance  $< 50$  kg N ha<sup>-1</sup>. This finding suggests that achieving high yields with a small N-balance and high PFP<sub>N</sub> are not conflicting goals. Indeed, the large variation in yield at the same level of N-balance highlights existing room to (i) increase yield with same N fertilizer rate, or (ii) attain same yield with less fertilizer, or (iii) both, by fine tuning crop and fertilizer practices.

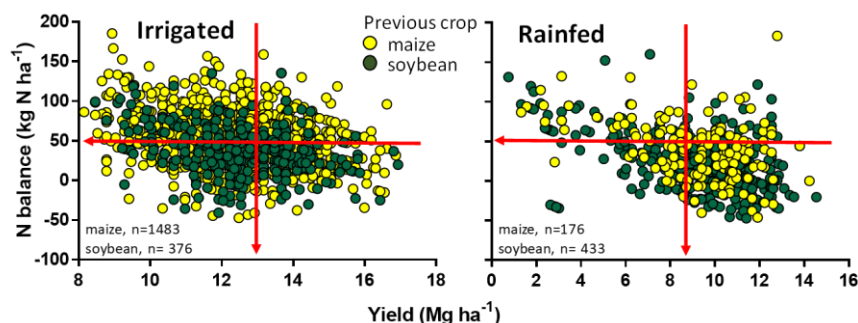

**Figure 1.** Nitrogen (N) balance in irrigated (left) and rainfed maize fields (right) plotted against grain yield. Each data point represents a field-year case. Data were disaggregated by previous crop: soybean (green) and maize (yellow). Horizontal arrows indicate N-balance = 50 kg N ha<sup>-1</sup>, which was used as a threshold to identify fields with large N surplus. Vertical arrows indicate average irrigated and rainfed maize yields. Linear regression between yield and N-balance (not shown here) was significant for all water regime x previous crop combinations ( $P<0.01$ ).

## **CONCLUSION**

This study presented a robust and generic framework to diagnose on-farm N footprint. When applied to maize fields in eastern NE, the framework showed that a substantial number of fields exhibited a large N surplus. However, there was (i) large yield variation at any level of N-balance and (ii) a negative relationship between N-balance and yield, suggesting substantial room for improving both yields and N-balance. Magnitude of N surplus depended upon water regime and crop sequence. The framework presented here can be easily extended to other cropping systems around the world as long as data on farmer yields and N inputs are available. Despite its simplicity and limitations, the N-balance approach provides farmers and a wide range of stakeholders with a clear indicators about the potential environmental footprint associated with N inputs use in agro-ecosystems.

## **REFERENCE**

Grassini, P., Cassman, K.G., 2012. High-yield maize with large net energy yield and small global warming intensity. *Proc. Natl. Acad. Sci. U.S.A.*, 109, 1074–9.

## EFFECT OF FEEDING THE GRASS FIBROUS FRACTION OBTAINED FROM BIOREFINERY ON N AND P UTILISATION OF DAIRY COWS

PIJLMAN, J.<sup>1</sup>, KOOPMANS, S.<sup>2</sup>, DE HAAN, G.<sup>3</sup>, LENSSINCK, F.<sup>4</sup>, VAN HOUWELINGEN, K.M.<sup>5</sup>, SANDERS, J.P.M.<sup>2,6</sup>, DERU, J.G.C.<sup>1</sup>, ERISMAN, J.W.<sup>1,7</sup>

<sup>1</sup> Louis Bolk Institute, the Netherlands; <sup>2</sup> GRASSA! BV, the Netherlands; <sup>3</sup> Gras- en Groenvoeders Hoogland Marrum B.V, the Netherlands; <sup>4</sup> Veenweiden Innovatiecentrum, the Netherlands; <sup>5</sup> Kennis Transfer Centrum Zegveld, the Netherlands; <sup>6</sup> Wageningen University and Research, the Netherlands; <sup>7</sup> VU University Amsterdam, the Netherlands

### INTRODUCTION

Biomass produced by intensively managed dairy grasslands on peat soils generally contains higher amounts of N and P than biomass from mineral soils, due to the relative high organic matter mineralisation under oxic soil conditions. Consequently, if these higher amounts are not compensated for in the ration by adding lower N and P feed components, dairy cows receive a dietary surplus of N and P which in turn leads to higher on farm N and P surpluses compared to farms on mineral soils (De Visser et al., 2001). Biorefinery can split grass biomass into a fibrous fraction with lower N and P concentrations, and a fraction with higher N and P concentrations. We hypothesised that substituting part of the grass silage by an ensiled grass fibrous fraction would not affect milk production but could improve cow N and P efficiency in a grass based dairy ration with a dietary surplus of N and P, which is a common situation in a dairy farming system on a peat soil.

### MATERIAL AND METHODS

On the 1<sup>st</sup> of August 2017, one half of a dairy grassland near Lelystad (the Netherlands) was harvested “conventionally” by mowing, tedding, raking and ensiling within a period of about 48h. Between 20 July and 14 August 2017, the other half of the dairy grassland biomass was refined into a N and P concentrated fraction and a fibrous fraction using a mobile installation with a refiner (GRASSA! BV, the Netherlands, 2<sup>nd</sup> prototype) followed by a screw-press (Keydollar, the Netherlands). The obtained fibrous fraction was directly ensiled. Average N and P concentrations in unrefined ensiled grass and the ensiled fibrous fraction were 37.3 vs. 29.4 and 2.8 vs. 1.9 g kg<sup>-1</sup> dry matter (DM), respectively.

In autumn 2017, a feed experiment was carried out to compare the effect of unrefined ensiled grass to the ensiled fibrous fraction of refined grass on dairy cow performance and N and P balance. The experiment was set up as a 2 x 2 Latin square, consisting of two dietary treatments (unrefined grass silage, UGS and grass fibrous fraction silage, GFS) and two experimental periods of 14 days each. Eight multiparous Holstein Frisian dairy cows were evenly assigned to each dietary treatment based on lactation number and stage. Cows in the UGS treatment received 13.0 kg DM grass silage per day, while cows in the GFS treatment received 8.0 kg DM of grass fibrous fraction silage in exchange for unrefined grass silage. Both diets were equally supplemented with 8.6 kg DM of concentrates. Average crude protein and P contents of the diets were 210 vs. 190 g kg DM<sup>-1</sup> and 3.3 vs. 3.0 g kg DM<sup>-1</sup>, respectively for treatments UGS and GFS. Diets were formulated to meet or exceed daily energy, protein and macro-mineral requirements for dairy cows (CVB, 2016).

Cows feed intake and milk production were monitored daily. During the last three days of each experimental period, feed, milk, spot faeces and spot urine samples were collected. Feed and faeces samples were analysed for DM, crude ash, acid-insoluble ash (HCl-ash), N and P content. Milk samples were analysed for protein, fat, N and P content. Fat and protein corrected milk (FPCM) was calculated as  $0.337 + 0,116 \times \text{fat percentage} + 0,06 \times \text{protein percentage} \times \text{kg milk production day}^{-1}$ . Urine samples were analysed for N, P and creatinine content. Dietary digestibility of N was determined by the HCl-ash in feed and faeces (Sales and Janssens, 2003). Total urine output was estimated assuming a fixed daily urinary creatinine excretion (De Boer et al., 2002). Differences between input

and output of N and P were assumed to be a result of retention and other losses than accounted for. Data was analysed by ANOVA using R (version 3.4.0, R core team, 2017).

## RESULTS AND DISCUSSION

Cows in the GFS treatment had a significant lower total feed intake ( $P=0.011$ ) compared to the UGS treatment (Table 1). The difference tended to be greater in the first compared to the second period ( $P=0.051$ ). Cows in the GFS treatment had a significant lower daily N intake ( $P<0.001$ ) and difference between N input and output ( $P=0.021$ ), and tended to excrete less N via urine ( $P=0.061$ ) compared to the UGS treatment. Furthermore, cows in the GFS treatment had a significant lower daily P intake ( $P<0.001$ ) and faecal P excretion ( $P=0.008$ ), and tended to have a lower daily difference between P input and output ( $P=0.089$ ) compared to the UGS treatment. Finally, the percentage of dietary N and P excreted via milk was significantly higher for cows in the GFS treatment compared to the UGS treatment ( $P=0.006$  and  $P=0.001$ , respectively). Since cows fed the GFS diet did not produce less FPCM but had a lower feed intake, it appeared that cows utilised the grass fibrous fraction more efficiently than the unrefined grass silage, although FCE was not significantly higher for the GFS treatment ( $P=0.304$ ). The significant lower N input and output difference, and tendency towards a significant lower P input and output difference for cows in the GFS treatment may have been a result of a higher daily dietary N and P surpluses, resulting in higher N and P body retentions of cows (Valk and Šebek, 1999).

Table 1. Feed intake, milk production and daily N and P balances of multiparous dairy cows fed a diet based on unrefined grass silage (UGS) versus cows fed a diet of which part of the grass silage is replaced by a grass fibrous fraction (GFS).

Parameter	Unit	Treatment		P-values		
		UGS	GFS	Treatment (T)	Period (P)	T x P
Total dry matter feed intake	kg cow <sup>-1</sup> day <sup>-1</sup>	21.5	20.0	0.011	0.697	0.051
Fat and protein corrected milk	kg cow <sup>-1</sup> day <sup>-1</sup>	30.7	30.3	0.801	0.475	0.541
Feed conversion efficiency	kg feed kg milk <sup>-1</sup>	1.39	1.49	0.304	0.979	0.320
N Intake	g cow <sup>-1</sup> day <sup>-1</sup>	721	605	<0.001	0.026	0.410
Faecal N excretion	g cow <sup>-1</sup> day <sup>-1</sup>	174	163	0.311	0.534	0.241
Milk N excretion	g cow <sup>-1</sup> day <sup>-1</sup>	162	162	0.970	0.846	0.735
Urine N excretion	g cow <sup>-1</sup> day <sup>-1</sup>	267	227	0.061	0.196	0.566
N input minus output	g cow <sup>-1</sup> day <sup>-1</sup>	117	52	0.021	0.742	0.525
P Intake	g cow <sup>-1</sup> day <sup>-1</sup>	71.0	60.4	<0.001	0.145	0.168
Faecal P excretion	g cow <sup>-1</sup> day <sup>-1</sup>	30.6	23.7	0.008	0.992	0.374
Milk P excretion	g cow <sup>-1</sup> day <sup>-1</sup>	28.4	28.0	0.783	0.666	0.521
Urine P excretion	g cow <sup>-1</sup> day <sup>-1</sup>	0.25	0.24	0.902	0.655	0.975
P input minus output	g cow <sup>-1</sup> day <sup>-1</sup>	11.7	8.5	0.089	0.434	0.389
Feed-N to milk-N	%	22.6	26.8	0.006	0.349	0.566
Feed-P to milk-P	%	40.0	46.4	0.001	0.429	0.527

## CONCLUSION

The fibrous fraction of grass obtained from biorefinery, being less concentrated in N and P than unrefined grass silage, improved dairy cow dietary N and P utilisation without affecting milk production. Biorefinery could be used as tool to reduce environmental N and P loads of dairy farms, especially in situations where diets are grass based and grass biomass is relatively rich in N and P, such as in a dairy farming system on peat soils.

## REFERENCES

- CVB. 2016. Tabellenboek Veevoeding 2016. Voedernormen Rundvee, Schapen en Geiten en voederwaarden voedermiddelen voor Herkauwers. CVB-reeks nr. 52, Federatie Nederlandse Diervoederketen, the Netherlands.
- de Boer, I. J. M., Smits, M. C. J., Mollenhorst, H., van Duinkerken, G., Monteny, G. J. 2002. Prediction of ammonia

- emission from dairy barns using feed characteristics part I: Relation between feed characteristics and urinary urea concentration. *Journal of Dairy Science* 85, 3382–3388.
- de Visser, P. H. B., van Keulen, H., Lantinga, E. A. and Udo, H. M. J. 2001. Efficient resource management in dairy farming on peat and heavy clay soils. *Netherlands Journal of Agricultural Science* 49, 255 – 276.
- Sales, J. , Janssens., G. P. J. 2003. Acid-insoluble ash as a marker in digestibility studies: a review. *Journal of Animal and Feed Sciences* 12, 383–401.
- Valk. H. , Šebek, L. B. J. 1999. Influence of long-term feeding of limited amounts of phosphorus on dry matter intake, milk production, and body weight of dairy cows. *Journal of Dairy Science* 82, 2157-2163.

## CROP RESIDUES DECOMPOSITION DYNAMICS IN FARMS PRACTISING CONSERVATION AGRICULTURE IN THE GRAND EST REGION, FRANCE

THIEBEAU, P., RECOUS, S.

FARE Laboratory, INRA, Université de Reims Champagne-Ardenne, Reims, France

### INTRODUCTION

Agriculture can contribute to attenuation of climate change, notably through the carbon sink function of agricultural soils, by promoting practices that increase soil organic matter. The reduction or suppression of tillage in so-called "conservation" farming systems modifies the restitution of crop residues within the agro-systems that apply them: they are no longer incorporated and mixed in the volume of ploughed soil, but kept on the surface in the case of direct sowing (DS), or partially incorporated into the first centimeters of soil in systems of simplified farming techniques (reduce tillage, RT). This plant biomass is thus found in the form of mulch partially in contact with the soil, which reduces its rate of degradation and increases the time required to release nutrients. Models for decomposition of organic matter should be adapted to take into account the characteristics of these residues and the fact that they decompose on the soil surface.

The objective of the work was to characterize and model the dynamics of degradation: loss of dry matter (DM), carbon (C) and nitrogen (N) of mulches of plant residues: maize (*Zea mays* L.), sunflower (*Helianthus annuus* L.), rapeseed (*Brassica napus* L.), winter wheat (*Triticum aestivum* L.) and winter barley (*Hordeum vulgare* L.), in agricultural situations practising RT or DS, from harvesting time to their disappearance from the soil surface.

### MATERIAL AND METHODS

This work was carried out with farmers belonging to a network of farmers practising conservation agriculture, in the Grand-Est region of France. The experiments took place over three years (2009 to 2011) during which contrasting climatic situations were encountered. Changes in mulches of residues on the soil have been monitored from crop harvests, according to a mulch removal protocol developed earlier by us (Thiébeau and Recous, 2016), with time intervals of one to several months between 2 samplings, depending on the nature of the residues and the time of year. The C and N concentrations of the remaining residues were determined on biomasses collected over time. The climatic conditions encountered during decomposition kinetics are expressed in number of normalized days (ND) for temperature, i. e. the time is expressed as the sum of the days at a reference temperature of 15°C (ND15), which permits to compare crop residue dynamics for the different sites and the three years.

### RESULTS AND DISCUSSION

Initial situations ranged from 400 to over 1200 g dry DM m<sup>-2</sup>. After one year, residue masses were less than 200 g DM m<sup>-2</sup> in all situations. We observed an absence of effect of the type of culture on the kinetics of mass loss. It is therefore possible to adjust these losses of DM (Fig. 1A), C (Fig. 1B) and N (Fig. 1C) of the residues according to a single function, of type:

$$Y = a \times [\text{Exp}(-b \times \sum \text{ND15})]$$

with:  $\sum \text{ND15}$  = sum of the temperatures in normalized days at 15°C

This means that the loss of mass, C and N was independent of the crop under consideration year and geographical location, and depended only on the sum of ND15. These results indicate that the temperature factor was the primary driver of residue decomposition dynamics at the soil surface for the climatic context of our study, driver more important than soil moisture and species-related chemical characteristics. This conclusion would not be valid in areas where it does not rain regularly. This is the case, for example, under tropical climatic conditions where

the rainfall regime controls decomposition even though the temperature varies little or not at all (Vanlauwe et al., 1995).

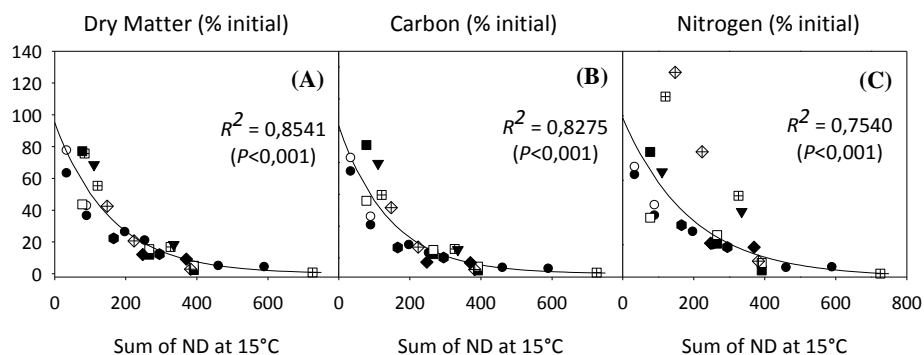

Figure 1. Dynamics of dry matter (A), carbon (B) and nitrogen (C) losses expressed (% initial) over time, expressed as a sum of normalized days (ND) at 15°C.

## CONCLUSION

These results indicate that by using simple adjustments based on a standardized time scale, it is possible to estimate the dry matter, carbon and nitrogen loss dynamics of these crop residues, and therefore for the latter element, indirectly, the supply (mineralisation) of N by soil crop residues. These results can therefore be included in simple terms, based on knowledge of the quantities returned and the average air temperatures, in decision-support tools for the management of organic matter and nutrients in agricultural systems with reduced tillage.

**Acknowledgements:** This work was funded by INRA and the PEPITES project (Ecological Processes and Technical Innovation Process in Conservation Agriculture) by ANR.

## REFERENCES

- Thiébeau P., Recous S., 2016. Une méthode pour quantifier les biomasses de résidus de récolte à la surface des sols après la moisson. Cah. Agric., 25 (4): 45001.
- Thiébeau P., Recous S., 2017. Dynamiques de décomposition des résidus de cultures sur les exploitations pratiquant l'agriculture de conservation en région Grand-Est, France. Cah. Agric., 26 (6): 65001.
- Vanlauwe B, Vanlangenhove G, Merckx R, Vlassak K. 1995. Impact of rainfall regime on the decomposition of leaf litter with contrasting quality under subhumid tropical conditions. Bio. Fertil. Soils, 20 (1): 8-16.

## AN EVALUATION OF NITROGEN BALANCES AT THE WHOLE-FARM AND FIELD SCALE ON 21 IRISH DAIRY FARMS

MURPHY, P.M.<sup>1</sup>, MURPHY, P.N.C.<sup>2</sup>, AND WALL, D.P.<sup>1</sup>

<sup>1</sup>Teagasc, Crops, Environment and Land-use Programme, Johnstown Castle, Wexford, Ireland. <sup>2</sup>School of Agriculture and Food, University College Dublin, Ireland.

### INTRODUCTION

Ireland's soil fertility: pH, P and K, has been in sharp decline since 2006 (Wall, *et al.*, 2013). As a result, approximately 10% of dairy farm soils currently have the optimum status of pH, P and K for intensive agronomic production. Differences occur between fields in management (fertiliser input and cropping) and biophysical properties (soil drainage class and topography). Such factors make maintaining soil fertility very challenging as resources become more limited. This project investigates the productive and environmental performance of individual fields using field scale nutrient balances. This paper focusses on field scale Nitrogen (N) balances as an indicator of N use sustainability. Additionally, the data collected for calculating nutrient balances were also used to model the environmental performance of these dairy farms with OVERSEER® (Wheeler, *et al.*, 2007).

### MATERIAL AND METHODS

21 farms were selected to represent different management and biophysical conditions across the south and south east of Ireland. Nitrogen balances were calculated at the field scale as follows: Nitrogen Balance = Nitrogen Inputs - Nitrogen Off-takes. Inputs were; fertiliser N, N in manure (Coulter, *et al.* 2008) and N in concentrate feed (based on protein content). Off-takes were; N in milk (based protein content), N in meat (McDonald, *et al.*, 1995). Herbage samples were also taken to determine the N concentration in the plant, but this was not used in the N balance as the N in herbage which is not exported off the farm (milk and meat), is recycled in manure. Linear regression analysis and analysis of variance (ANOVA) using R (R Core Team, 2013) was carried out to identify the most significant factors (management and biophysical) effecting field nitrogen balance. Experimentally, OVERSEER® was used to model the nutrient flows and estimate nutrient balance and N leaching in an Irish dairy farming system. A methodology was developed to parameterised and calibrate the model to typical Irish farms conditions

### RESULTS AND DISCUSSION

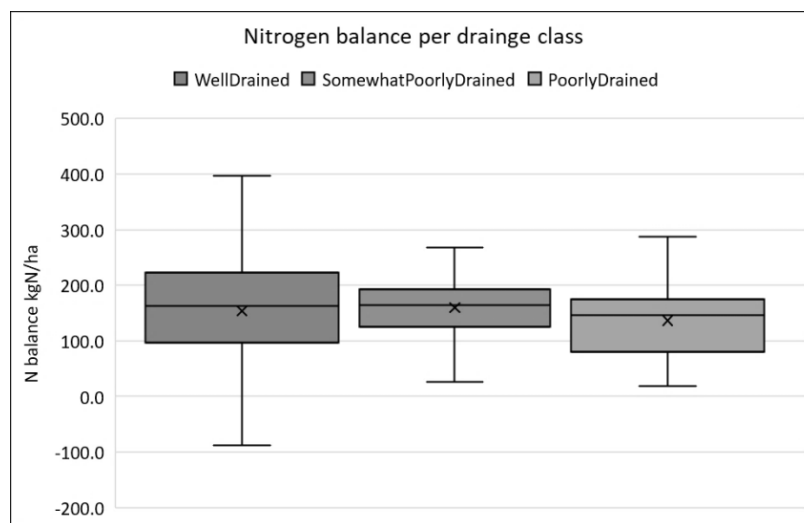

Figure 1. Field scale Nitrogen balance values (kg ha<sup>-1</sup>) for fields with three different types of drainage class.

Results are based only on fields used for the milking platform i.e. excluding fields used for beef or silage crop production. ANOVA analysis indicates that field scale nitrogen balances were significantly different between soil



drainage classes ( $p < 0.01$ ) (Fig.1.). Drainage class differences can be expected to be found across fields on every farm. Poorly drained soils are commonly water logged for long periods of time which increases the risk of N being lost in nitrate. Nitrogen inputs however are not amended to suit the different classes; total inputs are less, potentially because of poor trafficability during the growing season. Farm and sward composition (presence of *Trifolium*) also had significant effects,  $p < 0.01$  and  $p < 0.05$  respectively. Results for this study showed that N surplus was lower on fields when *Trifolium* (clover) was present. The remaining 51% of fields in this study did not contain clover and those fields had higher N balance values. This suggests the presence of clover influenced the N input in those fields. The significant difference between farms may be due to the range in stocking rate intensity and drainage characteristics of the farms selected. In terms of N balance calculations, chemical N input had a significant positive relationship with field scale nitrogen balance surplus ( $R^2 = 0.40$ ). Whereas milk exported had a negative relationship ( $R^2 = - 0.28$ ). Ways of increasing nitrogen use sustainability include reducing chemical N inputs and increasing exports of N in milk.

For the experiment with OVERSEER®, the model estimated an average  $49 \text{ kg ha}^{-1}$  N leached from the root zone on these dairy farming systems per annum. The amount of estimated N that actually reaches a waterway is unknown. Generally, the amount of N lost to water differs greatly depending on input (Ryan, M., 2002) and the ability of the soil to buffer N. This result will be further validated in a follow-up paper.

## CONCLUSION

There are significant differences between fields in both management and biophysical characteristics. Soil drainage can be overlooked; however, it is significantly influencing the nitrogen balance at the field level and ultimately farm level too. Clover presence is a sward composition factor that also influenced nitrogen balance, but the majority of fields are not managed to include clover. Management differences between farms and fields can be influenced by improved extension services. Currently fertiliser N recommendations are not anchored by any tangible field level factor or coefficient value. Field level differences are affecting the nitrogen cycle and so influence the productive and environmental performance of the fields. N recommendations customised to field level differences may improve nitrogen use sustainability. Field scale nutrient balances are an effective indicator of the impacts these factors have on nutrient use efficiency. Increased N use efficiency could be achieved by more targeted distribution of N inside the farm boundary. A fertiliser strategy that builds-in field level biophysical and nutrient requirements factors would be a progressive step towards improving the production, economic and environmental sustainability of Irish dairy systems.

## REFERENCES

- Coulter, S., Stan Lalor, Contributors Stephen Alex, Alastair Black, Andy Boland, Jim Burke, Owen T. Carton et al. "Major and micro nutrient advice for productive agricultural crops." (2008).
- McDonald, P., R. A. Edwards, J. F. D. Greenhalgh, and C. A. Morgan. "Animal Nutrition 5th." *Essex: Pearson Education Publishers* (1995): 49-127.
- R Core Team (2013). R: A language and environment for statistical computing. *R Foundation for Statistical Computing*, Vienna, Austria. URL <http://www.R-project.org/>.
- Ryan, M. "Nitrogen losses in relation to soil type." In *Proceedings of the Fertilizer Association of Ireland's Winter Scientific Meeting* (2002), no. 39, pp. 3-12.
- Wall, D. P., Philip Jordan, A. R. Melland, P-E. Mellander, S. Mechan, and G. Shortle. "Forecasting the decline of excess soil phosphorus in agricultural catchments." *Soil Use and Management* 29, no. s1 (2013): 147-154.
- Wheeler, D. M., S. F. Ledgard, and R. M. Monaghan. "Role of the Overseer® nutrient budget model in nutrient management plans." *Designing sustainable farms: critical aspects of soil and water management* (2007): 58-62.

## **UMT ALTER’N: TO STRENGTHEN THE STRATEGIC FARM ADVISORY FOR CROPPING SYSTEMS BASED ON LEGUME CROPS OR ORGANIC FERTILISERS WITH LOW NITROGEN LOSSES AND LOW DEPENDENCY TO SYNTHETIC FERTILISERS**

SCHNEIDER A.<sup>1</sup>, COLNENNE-DAVID C.<sup>2</sup>, CADOUX S.<sup>1</sup>, DROUET J.-L.<sup>3</sup>, HOUOT S.<sup>3</sup>, JEUFFROY M.-H.<sup>2</sup>, LE GALL C.<sup>1</sup>, REAU R.<sup>2</sup>

<sup>1</sup> Terres Inovia, France; <sup>2</sup> INRA Agronomie – AgroParisTech – Université Paris-Saclay, France; <sup>3</sup> INRA Ecosys France

### **INTRODUCTION**

Supported by the ministry in charge of agriculture since 2015, the 5-year programme Alter’N aims to produce resources to support strategic advice for the insertion of legumes (nitrogen fixing crops) and for the valorisation of organic fertilizers in productive crop systems with low nitrogen (N) losses. Its objective is to deliver actionable knowledge and operational resources which will help agricultural and environmental actors to diagnosis, design, assess and manage N-efficient cropping systems including legume crops and/or organic fertilisers.

The priority is to strengthen joint analysis of current state-of-the-art to deliver clear and agreed messages, and to develop specific tools and methods for designing, managing and evaluating crop systems including these “Alter’N” sources in complement (or replacement) of the industrial mineral N, so that they are productive and with low N losses.

### **INSTITUTIONS INVOLVED**

Based at Grignon, Alter’N involves Terres Inovia and two research units of INRA, UMR-Agronomie and UMR Ecosys. Its consultative Committee ensures interactions with Acta, Arvalis-Institut du Végétal and ITB as well as representatives from RMT « Fertilisation et Environnement », and RMT « Systèmes de Culture innovants ». The programme is developed in close collaboration with other R&D teams, such as the UMR INRA SAS at Rennes, UMR AgroEcologie at Dijon, UMR AGIR at Toulouse, UR AgroImpact at Laon, LEVA-ESA Angers, as well as collaborations through European and international networks.



### **THEMATIC AXES**

The programme of UMT Alter’N includes four thematic axes:

Axis 1. Build an integrative approach of N losses: in order to gain knowledge on N-losses and interactions among the different types of N losses, to develop simulation tools which are adapted to the alternative sources. Current work aims at adapting parameters of existing crop models (CERES-EGC, STICS, Azodyn), and of tools simulating all types of N losses (Syst’N), in order to better reproduce measured dynamics related to these sources and alter’n based systems.

Axis 2. Improve knowledge about specific dynamics of N from legume crops and organic fertilisers: current progress in knowledge are summarized into operational references and complemented with on-going studies.

Axis 3. Test, design and assess cropping systems including N alternative sources, by quantifying N fluxes and losses in a wide range of cropping systems: on the basis of past or current crop systems trials, data of measurements and multi-assessment outputs are discussed and simulations are investigated.

Axis 4: Make diagnosis of N losses, design and manage N-efficient crop systems with the actors from territorial authorities and value chains: collaborations with public or private partners are developed in activities at regional level or value chain scale.

## UP TO DATE ACTIONS

### The main activities developed so far are:

- ✓ Collaborations among UMT's partners, with exchanges of information (expertise, on-going activities) thanks to regular meetings (at management board or plenary levels) to share information and plan future plans ;
- ✓ Data acquisition and analyses of the dynamics of nitrogen fluxes in cropping systems issued from these specific sources (laboratory and field trials as well as modelling studies) ;
- ✓ Data acquisition and analyses of different cropping system experiments with innovative cropping systems managed under some environmental constraints or with multi-performant objectives (SIC, La Cage, Phyto-Sol, SYPPRE, sites from SOERE PRO such as Qualiagro) ;
- ✓ Development or contribution of joint projects at regional, French or European levels (ANR-Legitimes, PSDR-PROLEG, Ademe-PROTERR, ADEME-Methapolsol, Casdar-AgroEcosyst'N, Casdar-Outillage, H2020-LegValue, H2020-DiverImpacts, etc.);
- ✓ Organisation of specific thematic workshops with other groups of experts in nitrogen or cropping systems issues, to share expertise to diversify nitrogen sources and change N management in crop systems ;
- ✓ Collaboration with regional partners to share territorial analyses related to the insertion of such sources in agricultural production.

### The major plans for the future are to:

- ✓ Continue the improvement of simulation tools including nitrogen losses in the different environmental compartments: defining adapted parameters for these « Alter'N » sources and developing simulations of regional crop systems cases in (i) Syst'N tool (Casdar-AgroEcoSyst'N) and (ii) SIMEOS-AMG and STICS models ;
- ✓ Reinforce the joint analyses on grain legume N dynamics and related ecosystem services (level of system productivity, quantity of inputs, level of polluting fluxes) in order to provide operational schemes taking into account the optimal expression of their benefits in the system conception with adapted management ;
- ✓ Formalize the methodologies for territory diagnosis of water quality management and develop the territorial management of organic fertilizers or urban residual materials with regional partners;
- ✓ Share successful cases of farm systems with organic fertilisation or legume crops and further analyse the organisation of legume value chains in different French and European case studies;
- ✓ Investigate operational ways for actors to get financial value of the ecosystem services issued from harvested grain legumes into crop successions into operational territorial or value chain projects.

## REFERENCES

<http://www.terresinovia.fr/umt-altern>

## COMPARATIVE ANALYSIS OF SOME ECOSYSTEM SERVICES COMPONENTS LINKED TO NITROGEN FLUXES OF CROPPING SYSTEMS WITH GRAIN LEGUMES

SCHNEIDER A.<sup>1</sup>, ODDOS L.<sup>1</sup>, PELZER E.<sup>2</sup>, JEUFFROY M.-H.<sup>2</sup>

<sup>1</sup> Terres Inovia, France; <sup>2</sup> INRA, UMR Agronomie, AgroParisTech, Université Paris-Saclay, France

### INTRODUCTION

In the current French arable cropping systems mainly based on cereals and oilseed rape, legume crops provide both a botanic diversification and nitrogen supply, thanks to their ability to fix atmospheric N<sub>2</sub>. However, ecosystem services provided by legumes are not well characterised according to each context, preventing them to be fully valued by a large number of farmers. For instance, the effects of legume crops on the performances of following crops rely usually on i) average estimates, ii) only in cases of some couples of species, and iii) based on fragmented data (as synthesized in Jeuffroy *et al.* 2015). And the major factors explaining the variability of these effects are not known. This prevents to forecast the crop system and adapted technical management which would have led to optimal services in a given context, such as enhanced production with lower charges. In order to complement on-going analysis of a series of detailed traits in one location (Guinet 2016), our study aims to contribute of multiplying the trial contexts in order to address the comparative characterisation of some variables and related services provided by grain legume crop to the following (or intercropped) crop.

### MATERIAL AND METHODS

Several trials were carried by partners of the UMT Alter'N. The trials managed by the Technical Institute Terres Inovia aim at quantifying some services of pea, faba bean, lentil crops compared with non-legume crop (wheat, rape) in two locations (« Berry » in the Indre area since 2015, and « Grignon » in the Yvelines area since 2016) in different couple of years. Berry trial is characterized by a superficial calcareous-glay soil and a high organic matter content (3,1%) whereas Grignon trial has a deep silty soil with a rather organic matter level (between 1,3 and 1,9%). The yields of 2016 harvest were exceptionally low for all winter type crops, with strong disease damages, which occurred in May.

Several variables were analyzed: yield (quantity and quality), N fixed (%Ndfa, following 15N enrichment in the case of analytical trials), residual mineral soil nitrogen (at 3 dates), crop and grain nitrogen content, soil biological activity indicator (soil nematofauna), and, in one location, N<sub>2</sub>O emissions. Preceding crops on year n include non-legume crops (wheat and oil seed rape in both locations), and legume species (winter pea and pea-wheat intercrop in both locations, winter faba bean and spring lentil only in Berry, spring faba bean and spring pea only in Grignon). Following crops on year n+1 include wheat and oilseed rape without N fertilisation (0N) or with a suboptimal N fertilisation (N1). The objectives of the first stage analysis (on the current set of data) are (i) characterize the service of the nitrogen fixation especially through the quantity of nitrogen issued from N fixation; (ii) compare the potential of modifying the yield of the following (or intercropped) crop.

In addition, links with on-farm situations are initiated thanks to comparison with on-farm observations followed by INRA in Burgundy. In this latter, 46 farming systems have been followed during two years with three series between 2015 and 2018 (5-7 fields per legume species each year). The aim is to quantify, in farm conditions, the variability of performances of legumes (spring pea and alfalfa) and of the following wheat: yield (quantity and quality), N fixed, N balance, residual mineral soil nitrogen.

### RESULTS AND DISCUSSION

At that stage, three series of « preceding crops » (Berry16, Berry17 and Grignon17) and a single series of « following crop » (Berry17) of the analytical experiment are available to analyse variables linked to ecosystem services of harvested grain legumes. The tendencies are summarized here below for two types of services:

**« Symbiotic nitrogen entry » service**

Symbiotic fixation rates (%Ndfa) were high in Berry (compared to reference data): about 75-80% for pea and lentil (versus 60-70%) and 90% for the faba bean (versus 70-80%). In Grignon, on the contrary, %Ndfa rates were particularly low for monospecific peas, about 40%, but remained higher for the intercropped pea (75%). There is a strong inter- and intraspecific variability depending on year and location. This variability is confirmed with results from Burgundy on-farm trials, which underline that fixed N rate (and amount) was higher in fields with higher potential. According to a principal component analysis, the dispersal of individuals is mainly explained by the quantity of fixed nitrogen (QNdfa) and the dry biomass (grains + stems) at harvest. Three groups can be distinguished and associated with three different situations Berry16, Berry17 and Grignon17: low biomass and QNdfa not affected by diseases for the first group, high biomass production and high QNdfa for the second one, and high biomass production but lower QNdfa for the third one. No particular relation between the %Ndfa and the residual soil mineral nitrogen content before or after winter was observed in trials and farmers’ fields. In farmers’ fields of Burgundy, wheat yield was higher after pea when the amount of N in pea straws and the pea yield were higher.

**“nitrogen absorption by the following crop”**

The service directly derived from the preceding effect of pea enables the following wheat to absorb from 59% more than the wheat which follows a cereal and it leads to a rape which has absorbed 38% N more than rape crop which follows wheat. The trends confirm previous results of another trial (2009-10).

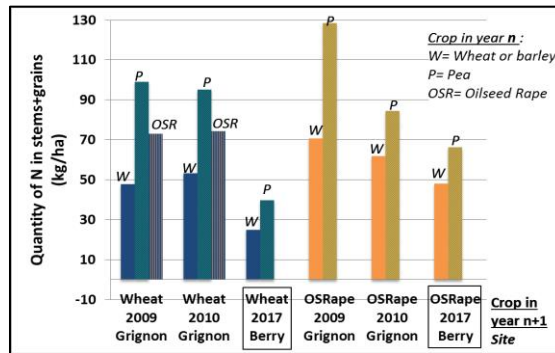

Figure 1. Quantity of nitrogen absorbed in the following non-fertilized crop (wheat or oilseed rape) according to its preceding crop.

**The « yield level of the following crop » service**

Figure 2 shows the results for the case of the year 2017, taken into account the specific conditions for the preceding crop in 2016 campaign marked by a normal growth during most of the crop cycle but strong damages before harvest. It shows that the legume crop leads to higher non fertilized wheat yields compared to a wheat as preceding crop and that the pea effect is significantly higher than the effect of lentil or pea-wheat association. The latter leads to higher yields of non fertilised rape compared with fababean, lentil or wheat, whereas the differences between the other preceding crops effects are not significant. There is a linear relation between the ON wheat yield and the amount of nitrogen (QN) in crop residues of the preceding crops, but not for the ON rape yields.

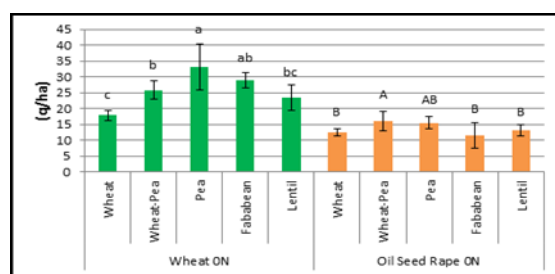

Figure 2. Yields of non-fertilised (ON) wheat or oil seed rape according to its preceding crop in Berry trial for 2017 harvest.

This first set of results will be further complemented (additional couples “year x location”, other variables and services). This will be also further compared to results issued from other partners’ trials (especially from project ANR-LEGITIMES) and from a meta-analysis (1) to enable deeper analysis on a wider set of data.

## REFERENCES

- Cernay C., 2016. Identifier des légumineuses à graines productives en Europe par synthèses quantitatives de données à large échelle. Thèse. 322 pages.
- Guinet M., 2016. Quantification of nitrogen fluxes and explanatory traits. Legumes for a sustainable World 11-14 October 2016, Troia, Portugal.
- Jeuffroy *et al.*, 2015. Performances agronomiques et gestion des légumineuses dans les systèmes de productions végétales, *In*: Les légumineuses pour des systèmes agricoles et alimentaires durables, Schneider et Huyghe, Ed Quae, pp.139-224.

This communication is associated to the working programme of the UMT Alter’N: <http://www.terresinovia.fr/umt-altern>

## OPTIMISING N-TRANSFER IN OILSEED RAPE BASED CROP ROTATIONS IN NORTHERN GERMANY

ROSE, M.<sup>1</sup>, PAHLMANN, I.<sup>1</sup>, KAGE, H.<sup>1</sup>

<sup>1</sup> Institute of Crop Science and Plant Breeding, Christian-Albrechts-University, Germany

### INTRODUCTION

Especially in regions with high precipitation rates during drainage period and in fertilizer intensive cropping systems, the risk of N losses is very high. In northern Germany, winter oilseed rape (OSR) is an important break crop in cereal crop rotations. After harvest of OSR high contents of soil mineral nitrogen (SMN) are common, typical subsequent crops such as winter wheat (WW) show little N uptake in autumn (Henke et al., 2008). Thus, there is an increased potential of N leaching after OSR and N transfer between the crops is suboptimal. Ecological and economic factors necessitate keeping N in the agroecosystem. There are different ways to decrease N leaching, e.g. optimizing N fertilization or growing catch crops (CC) during the drainage period (Constantin et al., 2010). The latter option often results in a modified crop rotation. A project of the European Innovation Partnership (EIP) compares local and adjusted crop rotations regarding improved N transfer under the environmental conditions of northern Germany.

### MATERIAL AND METHODS

The field trials were established in 2015 at three typical sites in northern Germany. At each site a local common crop rotation was compared to different adjusted crop sequences. Bristle oat (*Avena strigosa*) was used as the catch crop. The experimental design was a split-plot design with four replications. A plot contains one cultivar with five nitrogen fertilization levels (from no fertilizer to oversupply), thus the effect of preceding crop on optimum N rates ( $N_{opt}$ ) and thereby N transfer can be determined.

After harvest and during the drainage period (October to March) SMN contents were observed at intervals of about two weeks to detect SMN dynamics under differing subsequent crops. In December, destructive measurements were carried out to observe N contents in the above-ground biomass. During the vegetation period, N uptake dynamics of subsequent crops were observed non-destructively with a handheld spectrometer system (HandySpec Field<sup>®</sup>, tec5). For data processing, the statistical environment R (R Core Team, 2016) was used. Statistical significance was evaluated at  $P \leq 0.05$ .

The presented data were collected in 2016/2017 at Hohenschulen Experimental Station of Kiel University. N dynamics under WW are compared to CC following OSR (fertilized with  $210 \text{ kg N ha}^{-1}$ ) and the effect on  $N_{opt}$  of silage maize (SM) grown after OSR – CC (adjusted crop rotation) vs. a common sequence WW – bare fallow (BF) is studied.

### RESULTS AND DISCUSSION

Different SMN dynamics after OSR occurred depending on subsequent crop, similar to observations by Kramberger et al. (2009). There is evidence that these differences are partly based on higher N uptake through the grown catch crop. Bristle oat showed significantly higher N contents in above-ground biomass in December (about  $100 \text{ kg N ha}^{-1}$ ) than winter wheat (about  $25 \text{ kg N ha}^{-1}$ ). No differences occurred in N uptake dynamics from sowing to flowering of SM depending on preceding crop but  $N_{opt}$  was significantly lower in the adjusted crop rotation; there was no effect on yield (Figure 1). The difference between N uptake of CC and fertilizer N reduction in maize suggests N immobilization through CC residues. Constantin et al. (2010) showed increasing N stocks in soil organic matter through establishing CC.

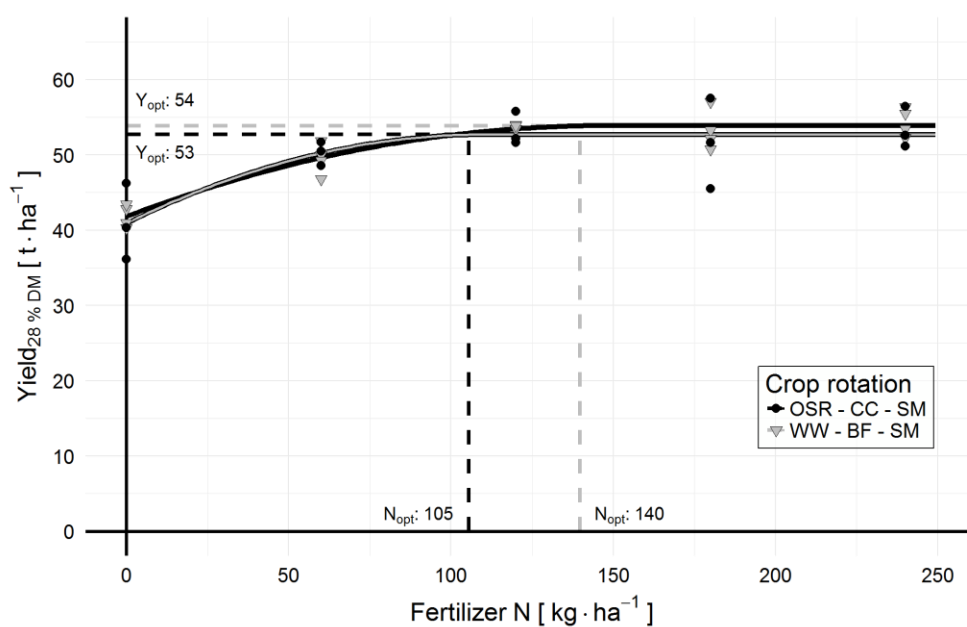

Figure 1. Quadratic-plateau yield response functions of silage maize (SM) deferring on crop rotation. Market prices are assumed to be  $0.74 \text{ € kg}^{-1} \text{ N}^{-1}$  and  $75 \text{ € t}^{-1} \text{ SM}$ , plot yields are corrected with factor 0.9.

## CONCLUSION

Field trials are still running and additional results will be included in analysis. Preliminary results show potential for improved N transfer and thereby reduced N leaching through adaption of crop rotations. But other studies suggest that establishing CC may not only result in lower optimal N rates of the subsequent crop but also in higher soil organic N stocks (Constantin et al., 2010). The collected data will be implemented in a soil-plant model to calculate N leaching of differing crop rotations.

## REFERENCES

- Constantin J., Mary B., Laurent F., Aubrion G., Fontaine A., Kerveillant P., Beaudoin N., 2010. Effects of catch crops, no till and reduced nitrogen fertilization on nitrogen leaching and balance in three long-term experiments. *Agriculture, Ecosystems and Environment*, 135, 268-278.
- Henke J., Böttcher U., Neukam D., Sieling K., Kage H., 2008. Evaluation of different agronomic strategies to reduce nitrate leaching after oilseed rape (*Brassica napus* L.) using a simulation model. *Nutr Cycl Agroecosyst*, 82, 291-314.
- Kramberger B., Gselman A., Janzekovic M., Kaligarić M., Bracko B., 2009. Effects of cover crops on soil mineral nitrogen and on the yield and nitrogen content of maize. *Europ. J. Agronomy*, 31, 103-109.
- R Core Team, 2016. R: A Language and Environment for Statistical Computing. R Foundation for Statistical Computing, Vienna, Austria.



## TOWARDS NITROGEN SELF SUFFICIENCY IN CROPPING SYSTEM OF CHALK SOILS IN CHAMPAGNE-ARDENNE AND PICARDIE (FRANCE)

CROS, C.<sup>1</sup>, DUPARQUE, A.<sup>2</sup>, REAU, R.<sup>3</sup>

<sup>1</sup>Chambre Régionale d'agriculture Grand Est, France; <sup>2</sup>AgroTransfert Ressources & Territoires, France; <sup>3</sup>INRA UMR Agronomie, France

### INTRODUCTION

The common crop systems on chalky soils of Champagne are capable of high productivity levels, using synthetic agricultural inputs, mainly nitrogen (N) synthetic fertilizer. Over the last 6 years, the average rate of N fertilizer application was 146 kgN/ha/year, which makes the Champagne-Ardenne region the third largest consumer of N fertilizer per hectare in France (UNIFA, 2016). The fluctuation of energy cost and the strengthening of national and European regulations make the dependency on synthetic N fertilizer an issue for the economic health of farms in chalky soils. Moreover, adding fertilizer N to agricultural systems is accompanied by environmental issues due to N losses to the atmosphere and water.

In the Champagne-Ardenne region, the representatives of regional chambers of agriculture and agricultural cooperatives decided to explore alternative practices in order to reduce the rate of synthetic N fertilizers, without decreasing the quantity and the quality of the crop production. Thus, the Auto'N project was launched in 2013 and the objectives were:

- To design alternative crop systems and to evaluate their sustainability;
- To highlight the use and the efficiency of alternative N sources and to promote alternative practices towards the farmers of chalky soils;
- To provide and test a method for advisers to accompany farmers in changing practices.

### MATERIAL AND METHODS

#### A novel design method (Reau and al., 2012)

We worked with 7 “pioneers” farmers and their advisers to design and implement alternative crop systems. The method combines “de novo” designs and step-by-step designs (Meynard and al, 2012). “De novo” design consists of creating a new crop system, forgetting the current one, by gathering information inside the “pioneers” group in “design workshops” (Bertet, 2013). Before each workshop, the central farmer assesses his satisfaction for each service linked to N management: crop nutrition, limitation of N losses and carbon storage in soil. This assessment is formalized in a global target, submitted to the group during the workshop. The other farmers, considered as “consultants”, are invited to propose all the ideas which would help the central farmer to reach his target. There were 7 design workshops, so that each farmer became the central farmer once. After these workshops, each farmer chooses the practices to test in his farm and designs a crop system with the animator and his adviser. This step requires a thorough analysis of his motivations, through the characterization of the results he observes in his fields.

After the *de novo* design step, a “step by step” design begins based on the yearly results from the fields. Observations and measurements are realized during 5 years to evaluate the services of N in the crop system. Each year, the project animator and the farmer’s adviser analyze how the farmer evaluates his results and help him to understand why failures happened, if happened. Then the farmer can decide to change practices in order to avoid other failures and/or to change his expectations on crop results. If all the expected results are obtained, the farmer also can decide to apply this crop system on other fields of his farm. The traceability of practices, decision rules and production performances is used to characterize *a posteriori* the crop systems. These data are also used to improve our knowledge on water and N fluxes in chalky soils.

### RESULTS AND DISCUSSION

De novo design process has been improved over the 7 design workshops in 2015 and 2016. The rules of the workshops imposed to forget the regulation and economic constraints and to adopt a high tolerance for the target and project of the other farmers. Once these rules were accepted, we observed that the farmers focused on an agronomic analysis of their practices and showed their will to understand N fluxes in their fields. The diversity and the large quantity of ideas generated during the workshops showed that the farmers let express their creativity and their expectations. Finally, they chose to explore different ways to reduce N consumption, corresponding to their motivation, their sensibility and their technical and economic constraints.

Table 1. Description of the 7 cropping systems designed and tested by the “pioneer” farmers in 2016

<b>Expected services of N</b> (OM = Organic Matter)	No economic losses because of N shortcut or excess OM storage	No production losses because of N shortcut Low level of N losses	No production losses because of N shortcut OM storage	No economic losses because of N shortcut OM stock maintenance	No production losses because of N shortcut Low level of NO <sub>3</sub> losses	No production and economic losses because of N shortcut
<b>Synthetic N input</b>	89 kgN/ha/yr	124 kgN/ha/yr	110 kgN/ha/yr	12 kgN/ha/yr	103 kgN/ha/yr	131 kgN/ha/yr
<b>Practices</b>						
<b>Crops with low needs in N</b> (W = winter, S = spring)	Sunflower, S barley (instead of rape and W wheat)	/	S barley (instead of W barley)	Fodder W wheat or S barley (instead of miller wheat)	S barley (instead of W wheat)	Sunflower (instead of rape)
<b>Legume crops</b> (frequency)	S pea and clover (17%)	W pea (12,5%)	Alfalfa (10,5%)	Legume seeds (20%)	Alfalfa (10%)	Lens, Alfalfa (18%)
<b>Intercrop cover</b> (frequency)	83 %	63 %	42%	20 %	43 %	41 %
<b>Organic N input</b>	Compost and manure every 3 years	Vinasse every 2-3 year	Vinasse every 3 years	Digestate every year	Composted manure every 3 years	Manure with straw every 6 years
<b>Efficiency of synthetic N input</b>	Date of input according to rain forecast	5 inputs on wheat and pilotage	Liquid N with sulfur and pilotage	Burying digestate 24h after input	Liquid N with sulfur, 4 inputs on wheat	Pilotage on rape and wheat

## CONCLUSIONS

The main alternative practices designed by “pioneer” farmers were (i) choosing, between crops of similar gross margin, the one with the lowest N need, (ii) using organic N instead of synthetic N for spring crops and (iii) improving management of intercrops to recycle soil mineral N surplus and fix atmospheric N<sub>2</sub> with legumes. These alternative practices lead to a synthetic N input 30% lowest than the average rate of N fertilizer application in Champagne-Ardenne. Two farmers explore additional practices at farm level in order to suppress the use of any synthetic mineral N fertilizer: producing N fertilizer with a methanation unit, or converting the entire farm in organic farming.

## REFERENCES

- Berthet E., 2013. Contribution à une théorie de la conception des agro-écosystèmes: Fonds écologique et inconnu commun. Thèse de Doctorat en sciences de gestion. Paris: Économie, Organisations & Société, p. 248.
- Meynard J-M., Dedieu B. et Bos A.P., 2012. Re-design and co-design of farming systems. An overview of methods and practices, In: Farming Systems Research into the 21st century: The new dynamic. Ika Darnhofer, David Gibon, Benoît Dedieu, Editors, Springer, pp. 407-432.
- Reau R., Monnot L.A., Schaub A., Munier-Jolain N., Pambou I., Bockstaller C., Cariolle M., Chabert A. et Dumans P., 2012. Les ateliers de conception de systèmes de culture pour construire, évaluer et identifier des prototypes prometteurs. Innovations Agronomiques, 20, pp. 5-33.
- UNIFA, 2016. La fertilisation en France. Le marché en chiffres. [<http://www.unifa.fr/le-marche-en-chiffres/la-fertilisation-en-france.html>]

## N AND S CYCLES IN CRUCIFER-LEGUME COVER CROP MIXTURES

COUËDEL, A.<sup>1</sup>, ALLETTO, L.<sup>1,2</sup>, JUSTES, E.<sup>1,3</sup>

<sup>1</sup> AGIR, Université de Toulouse, INRA, INPT, INP-EI PURPAN, Castanet-Tolosan, France; <sup>2</sup> Chambre Régionale d'Agriculture Occitanie, 31321 Castanet-Tolosan, France; <sup>3</sup> CIRAD, UMR SYSTEM Univ. Montpellier, CIHEAM-IAMM, CIRAD, INRA, Montpellier SupAgro, 34980 Montpellier, France

### INTRODUCTION

Cover crops grown in rotation with cash crops provide ecosystem services by reducing pollution and anthropogenic inputs. Among cover crop families, crucifers can efficiently prevent nitrate and sulphate leaching by catching residual soil mineral nitrogen (N) and sulphur (S) to enhance N and S catch crop services (Couëdel et al., 2018a, 2018b). However, compared to legume cover crops, crucifers provide less mineralised N to the subsequent main cash crop (N green manure service). Bispecific crucifer–legume cover crop mixtures can be seen as a potential solution to increase biodiversity in cropping systems combining advantages of both species (Couëdel et al., 2018b). Nevertheless crucifers could be a poor companion crop for two main reasons: 1) they strongly compete for light, water and nutrients due to their rapid root and shoot growth and 2) they can have an allelopathic effect on legumes during their growth due to production of glucosinolates, which are exuded by roots in the rhizosphere and transformed into biocides such as isothiocyanates (Matthiessen and Kirkegaard, 2006). There is a lack of information on levels of ecosystem services linked to the N and S cycles provided by mixtures compared to sole cover crops. The aim of our study was to assess the trade-offs of bispecific crucifer-legume mixtures in comparison to sole cover crops on N and S cycles.

### MATERIAL AND METHODS

Experiments were conducted at two sites (near Toulouse and Orléans, France) over two years where few cultivars from eight crucifers (rape, white mustard, Indian mustard, Ethiopian mustard, turnip, turnip rape, radish and rocket) and nine legumes (Egyptian clover, crimson clover, common vetch, purple vetch, hairy vetch, pea, soya bean, faba bean, and white lupin) were tested in sole-crop and in 98 bispecific mixtures (substitutive design of 50%-50% density of sole crops). Statistical analysis was performed on four measured variables (shoots+roots): 1) N acquired, 2) S acquired, 3) N mineralised and 4) S mineralised, the N and S mineralization being calculated using respectively C:N and C:S ratios (Eriksen et al., 2004; Justes et al., 2009). Analysis of variance (ANOVA) was used to evaluate effects of site, year and cover crop type (sole crop or mixture) on each variable. Tukey test allowed distinguishing differences among cover crop types for each site-year. Statistical analyses were performed using R software (R Core Team, 2016), and differences among treatments were considered significant at  $P < 0.05$ .

### RESULTS AND DISCUSSION

Only few differences were obtained between cultivars compared. Consequently results were averaged at the species level and are presented here at the family level for highlighting the main messages.

Crucifer - legume bispecific mixtures provided the same N and S catch crop service (mean soil acquisition of 50 kg N ha<sup>-1</sup> and 12 kg S ha<sup>-1</sup>) and significantly increased the N green manure service (mean mineralisation of 22 kg N ha<sup>-1</sup>) compared to pure crucifers (mean of 8 kg N ha<sup>-1</sup>) (Couëdel et al., 2018a, 2018b). Despite half the density of crucifers, S green manure service was only reduced by 15% in the mixture (mean mineralisation of 5.5 kg S ha<sup>-1</sup>) (Couëdel et al., 2018a). On a species basis, despite the high and variable competition for abiotic resources generated by crucifers, no incompatibility of growth was observed in mixtures. Overall crucifers and legumes tested were sufficiently complementary to mutualise multi-ecosystem services by providing level of each service close to that of the best sole cover crop family (Table 1).

*Table 1. Services associated with nitrogen (N) and sulphur (S) cycles for crucifer and legume in sole crop (SC) or in mixture. The service is provided in proportion of the best sole crop family (average of all species tested), which then is considered at 100%.*

Service	Mean crucifer SC	Mean legume SC	Mean mixtures
N catch crop	100%	66%	98%
N green manure	18%	100%	63%
S catch crop	100%	30%	99%
S green manure	100%	23%	85%

## CONCLUSION

Our study confirms for a wide range of cover crop species and on four sites x years that crucifer-legume mixtures tested can provide multi-ecosystem services beyond well-known N management services. Therefore it can be recommended to diversify the species included in cover crops in order to provide a high level of multi-ecosystem services and to secure the success of cover cropping in particular for summer sowing carried out in dry regions or under low rainfall conditions.

**Acknowledgements:** This study was part of the CRUCIAL project, which was financially supported by the French Ministry of Agriculture (CASDAR project no. C-2013-05) and the Occitanie Region (CLE project no. 13053068).

## REFERENCES

- Couëdel, A., Alletto, L., Justes, É., 2018a. Crucifer-legume cover crop mixtures provide effective sulphate catch crop and sulphur green manure services. *Plant Soil*. doi:10.1016/j.agee.2017.11.017
- Couëdel, A., Alletto, L., Tribouillois, H., Justes, E., 2018b. Cover crop crucifer-legume mixtures provide effective nitrate catch crop and nitrogen green manure ecosystem services. *Agric. Ecosyst. Environ.* 254, 50–59. doi:10.1016/j.agee.2017.11.017
- Eriksen, J., Thorup-Kristensen, K., Askegaard, M., 2004. Plant availability of catch crop sulfur following spring incorporation. *J. Plant Nutr. Soil Sci.* 167, 609–615. doi:10.1002/jpln.200420415
- Justes, E., Mary, B., Nicolardot, B., 2009. Quantifying and modelling C and N mineralization kinetics of catch crop residues in soil : parameterization of the residue decomposition module of STICS model for mature and non mature residues. *Plant Soil* 325, 171–185. doi:10.1007/s11104-009-9966-4
- Matthiessen, J., Kirkegaard, J., 2006. Biofumigation and Enhanced Biodegradation: Opportunity and Challenge in Soilborne Pest and Disease Management. *CRC. Crit. Rev. Plant Sci.* 25, 235–265. doi:10.1080/07352680600611543

## **AUTUMN SOIL MINERAL NITROGEN CONCENTRATION AS POTENTIAL PREDICTOR OF NITROGEN LEACHING**

SWARTZ, E.<sup>1</sup>, BØRGESEN, C.D.<sup>1</sup>, BLICHER-MATHIESEN, G.<sup>2</sup>, PIIL, K.<sup>3</sup>, VINTHER, F.P.<sup>1</sup>, ØSTERGAARD, H.S.<sup>3</sup>

<sup>1</sup> Institute of Agroecology Aarhus University, Denmark; <sup>2</sup> Department of Bioscience Aarhus University, Denmark; SEGES, Denmark

### **INTRODUCTION**

Nitrogen (N) leaching from arable land to ground and surface water has been identified as an environmental problem in Europe (Kronvang et al., 2017). In Denmark, leaching from arable land (54% of the land area) is highly climate dependant and occurs mostly during autumn to early spring, where there is surplus precipitation and low evaporation. Denmark has greatly reduced its N emissions since the late 1980s and is currently transitioning from a national to a targeted regulatory approach (Jabloun et al., 2015; Kronvang et al., 2017). An approach towards targeted regulation of excess N is to consider the soil content of mineralised nitrogen (N<sub>min</sub>) of arable land. This is currently in use in Belgium and Germany for controlling N-inputs in groundwater protection zones. N<sub>min</sub> varies throughout the year; in autumn, it depends on the net mineralization, nitrogen uptake by crops, crop type, soil type and gaseous losses by denitrification.

Since nitrate in soil is highly soluble, it is argued that the residual N<sub>min</sub> (mainly nitrate) in the soil during autumn may be a valuable indicator of the amount of N which can potentially leach during the leaching season in autumn and winter. This project hypothesises that the N<sub>min</sub> in agricultural fields in the autumn can be used as a predictor to quantify the nitrogen that leaches during the leaching season when selected additional parameters are known. It is aimed to develop an empirical model to predict nitrogen leaching from agricultural fields based on N<sub>min</sub> measurements in the autumn and the field management data as supporting input variables ex. soil type, water balance and applied fertiliser. The optimal sample depth and sampling time in autumn to predict leaching will also be investigated. This study is ongoing throughout the duration of this year and it is aimed to present the model and results at the conference.

### **MATERIAL AND METHODS**

#### **Experimental sites and treatment**

Field management data was collected from eight experiments consisting of 76 fields with different crop sequences in Denmark starting from April 2014 up to March 2017 (three leaching seasons, where a leaching season is from October – March). The experimental sites were located at seven different locations throughout Denmark representing four Danish soil types (JB1, JB3, JB4, JB6) and had an average precipitation of 700mm. Crop sequences consisted of winter cereals (winter barley, wheat, rye), and spring cereals (spring barley, oats) combined with bare soil, volunteers or catch crops during winter. Different fertilisation rates were tested, ranging from 0 to 200% of the recommended N rate were applied.

#### **Measurements and calculations**

Soil mineral content was measured in composite samples taken in a depth of up to one meter. Each drilling was split into four depths (0-25cm, 25-50cm, 50-75cm, 75-100cm) and the samples from each depth was combined to make up four composite soil samples. Sampling occurred over three periods during Autumn; beginning with Round 1 (R1) in early October, Round 2 (R2) in early November and Round 3 (R3) at the end of November. The samples were analyzed for nitrate (NO<sub>3</sub><sup>-</sup>) and ammonium (NH<sub>4</sub><sup>+</sup>). Two monthly soil water samples were taken from ceramic suction cups installed at one-meter depth on each field (four blocks with two suction cups at each place). The soil water was analysed for NO<sub>3</sub><sup>-</sup> and NH<sub>4</sub><sup>+</sup>.

A water balance and hence the water drained from the soil profile (percolation) was calculated for each experimental plot using the DAISY 5.18 model. The soil water N concentration and percolation was used to calculate the N leaching from October – March for each plot and year.

Statistical and Principle Component Analysis (PCA) were performed in R-Studio (3.4.2) where plots were made using the ggplot and ggbiplot packages.

## RESULTS AND DISCUSSION

Preliminary PCA indicated that soil type and the depth of the sampling was the most important variable influencing the Nmin concentrations. Hereafter, followed the sampling time, fertilization level and sowing time. Higher levels of calculated leaching were observed for similar treatments with sandier soils (JB4) compared to soil with a higher clay content (JB6). Experiments with catch crops showed a clear reduction in excess Nmin in the autumn and calculated seasonal leaching compared to no catch crops during the autumn and winter. For example, Figure 1a illustrates the efficient utilization of the excess Nmin by ryegrass (catch crop) compared to the bare soil treatment during autumn following a summer harvest of spring barley. No fertilization treatments were applied to the catch crops, hence, the excess N applied to the spring barley was utilized by the ryegrass. Consequently, the calculated leaching (Figure 1b) was also significantly lower with ryegrass compared to the bare soil treatment due to much lower Nmin and thus much lower potentially leachable N present in the soil.

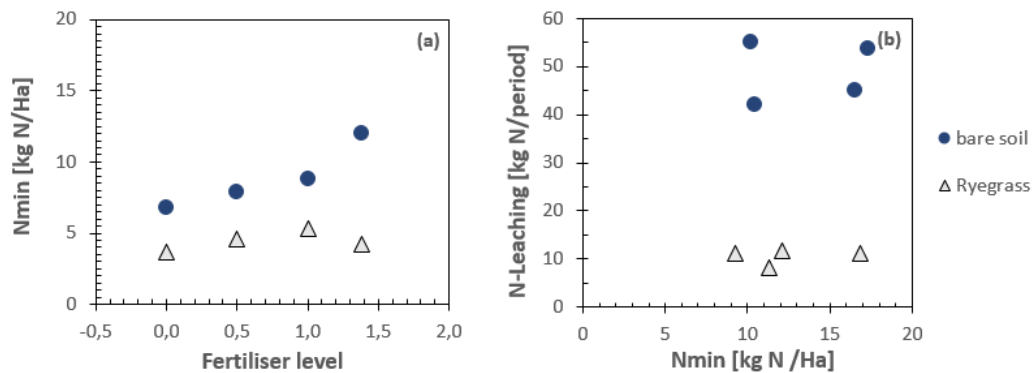

Figure 1. Spring barley with ryegrass as a catch crop (triangle) and bare soil (dark dot) as autumn/winter treatment on a JB4 soil in 2016. (a) Sampled Nmin (Round 3 at depth 0-25cm) with increasing fertiliser level and (b) calculated seasonal leaching vs. sampled Nmin (Round 3 at depth 0-25cm).

Early planting (at least 2 weeks prior to normal planting times) of the summer crop also resulted in lower Nmin and consequently lower calculated seasonal N leaching.

## CONCLUSION

The current results clearly indicate that the soil type, use of catch crops and sowing time of winter crops affects the Nmin in the autumn which as a result influences the potential leachable N present in the soil during the leaching season. The next steps in developing an empirical model for predicting seasonal leaching based on Nmin in the autumn will be (i) to establish which Nmin depth best correlates with the calculated leaching; (ii) to quantify the reduction of the different autumn/winter treatments on the calculated leaching. The results also showed that soil type is important for the relationship between Nmin and leaching, therefore (iii) a ratio of the Nmin and normalised leaching should be established for each soil type to be included in the model. Further conclusions of the study will be presented at the conference.

## REFERENCES

Jabloun, M., Schelde, K., Tao, F., Olesen, J.E., 2015. Effect of temperature and precipitation on nitrate leaching

from organic cereal cropping systems in Denmark. *Eur. J. Agron.* 62, 55–64.

<https://doi.org/10.1016/j.eja.2014.09.007>

Kronvang, B., Blicher-Mathiesen, G., Windolf, J., 2017. 30 years of nutrient management learnings from Denmark: A successful turnaround and novel ideas for the next generation. (No. 30), *Science and Policy: Nutrient Management Challenges for the Next Generation*. Massey University, Palmerston North, New Zealand.

## LIVING COVER COMPETITION IN BANANA PLANTATION AND NITROGEN MANAGEMENT AFTER A LEGUME COVER CROP ROTATION

ACHARD, R.<sup>1</sup>, ROSALIE, E.<sup>1</sup>, DOREL M.<sup>2</sup>.

<sup>1</sup> GECO, CIRAD UPR GECO, Campus Agroenvironnemental de la Martinique, 97232 Le Lamentin, Martinique, France;

<sup>2</sup> CIRAD UPR GECO, Neufchâteau, 97130 Capesterre, Guadeloupe, France.

### INTRODUCTION

Intercropping banana with a mown spontaneous cover or sown cover crop represents an alternative to herbicide use for the control of weeds. Intercropping a living cover induces nitrogen competition for the banana during the first crop cycle, then for following cycles the lower growth of the cover and the cycling of nutrient induced negligible competition effects (Achard, 2016). In that case, maintaining crop productivity for the first cycle supposed to compensate the additional nitrogen demand of the living cover by increasing N fertilization. An adaptation of N fertilization program to banana plantation with living covers without increasing N leaching, has been proposed through a modeling approach (Ripoche *et al*, 2012). The current question is to design herbicide free banana cropping system integrating living cover, in order to compensate the additional nitrogen demand of the living cover and ensuring a sufficient nitrogen availability to maintain banana productivity, without increasing leaching risk. The goal of this study was to evaluate, in the field, the performance of two herbicide free banana management options based on mechanical control of weeds after a previous cover crop, and determine if those options would require an increase of N fertilization and/or would increase nitrogen leaching risk.

### MATERIAL AND METHODS

The study was carried out in Martinique on nitisols, with a mean annual rainfall of 2400mm. Eleven month after sowing *Stylosanthes guianensis*, the cover crop was destroyed by mowing before banana plantation. The field trial compared three management treatments through a randomized block design with three replicates. The first management treatment (MW) combined no tillage, mulched soil with cover crop residues and weed control by mowing. The second treatment (PW) combined a soil tillage with a weed control by mowing and the control treatment (CT) consist in a conventional chemical control of weeds. Banana in vitro derived plantlets were planted with a 2.65 m x 1.5 m spacing, i.e. 4m<sup>2</sup> per plant. The fertilization corresponded to common producer's practice, and was equal for all treatments: 9 g N per plant at planting and 28 g N per plant at 60 and 120 days after planting (DAP), i.e. a total amount of 110 kg N.ha<sup>-1</sup> during this study. For P and K, the fertilization ensured a non-limiting nutrition of the banana plants. Each experimental plot consisted of six banana plants, surrounded by a border. The weed biomass was evaluated by destructive observations on 0.25 m<sup>2</sup> area per plot, randomly localized. The weed biomass was negligible on CT. The banana growth was estimated through the pseudostem girth and the leaf emission, the biomass of banana plants was estimated by an allometric relation. The relation between %N content and the banana biomass from Thieuleux (2006) was used.

### RESULTS AND DISCUSSION

#### Cover crop production and weed growth

At 30 days after planting (DAP), despite the mulch of *S. guianensis*, MW had significantly higher weed biomass in comparison to PW (130 g/m<sup>2</sup> vs 50 g/m<sup>2</sup>), meaning that mulching with *S. guianensis* is less efficient than soil tillage for controlling weed emergence. At 100 DAP, just before the first mowing, weed biomass remained higher on MW treatment than on PW with 0.88 and 0.44 kgDM/m<sup>2</sup> (corresponding to 18 and 9 gN/m<sup>2</sup>), respectively.

#### Banana growth response

Banana plants had similar growth response in CT and PW (cf. table1) until 100 DAP. However, at 160 DAP on PW, banana plants had lower growth and leaves emission. As CT and PW managements distinguished only according to their mowing management of weed, the depressive effect of MW reflected the weed competition effect. In



spite of a high growth of weeds, MW treatment showed better banana growth than PW and did not suffer from any reduction of banana growth in comparison to CT.

Table 1. Response of the banana pseudostem girth to experimental treatments

Experimental treatment	48 DAP		100 DAP		160 DAP	
	C30	FE	C30	FE	C30	FE
MW: Mulch + weed cover	11.9 A	5.5	27.0 A	15.23 A	60.9 A	26.01 A
CT: Ploughing + chemical weed control	10.8 AB	5.5	24.1 AB	14.41 AB	56.8 A	25.97 A
PW: Ploughing + weed cover	9.4 B	6.1	22.3 0 B	13.96 B	49.13 B	24.25 B

### Evolution of the total nitrogen uptake by plants component and the soil mineral nitrogen content

By comparing the estimated nitrogen uptake of the weeds and of the banana plants (cf. figure 1) in control treatments (CT) with PW, we observed that the high amount of nitrogen uptake by weed cover induced a reduction of other N compartment distributed among the N banana uptake and N mineral soil content. However, on MW, instead of weak depletion of mineral N of the soil, there was an increase the global N content of the agrosystem.

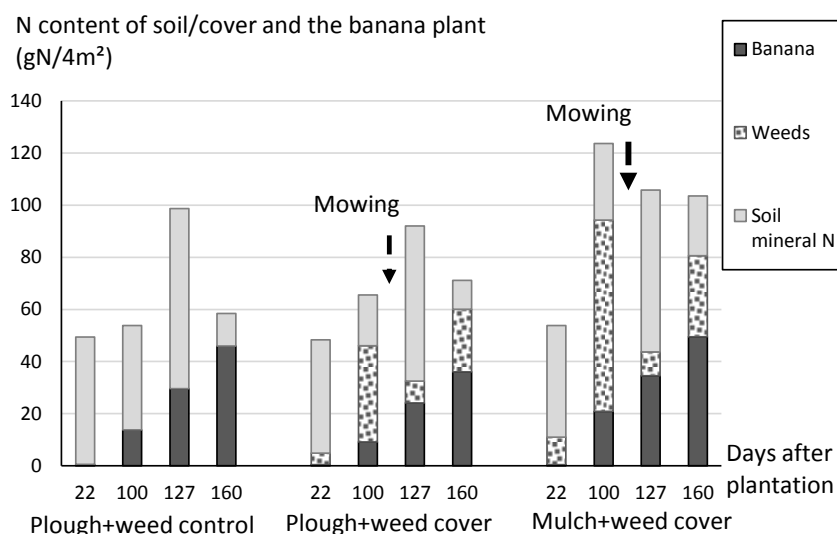

Figure 1. Dynamic of the repartition of N uptake between weeds banana crop and soil mineral nitrogen.

### CONCLUSION

PW management had an impact by competing with banana growth, that needs to be compensated for by an increase of Nitrogen fertilization. As MW management has no negative impact on the banana growth this management would not require an increase of nitrogen fertilization, its higher nitrogen amount in comparison to conventional management indicated lower nitrogen leaching until this crop stage.

### REFERENCES

- Achard R., 2016. Etude du fonctionnement d'associations entre le bananier et une couverture vivante ; évaluation des potentialités et stratégies d'utilisation de plantes de service pour contrôler les adventices. Thèse de doctorat, Université Paris-Saclay, pp. 187.
- Ripoche A., Achard R., Laurens A., Tixier P., 2012. Modeling spatial partitioning of light and nitrogen resources in banana cover-cropping systems. Eur. Journ. Agr. Vol 41, 81-91.
- Thieuleux, L., 2006. Biodisponibilité de l'azote en cultures bananières sur nitisol. Ph.D. Thesis. Université des Antilles et de la Guyane, Guadeloupe, France, pp. 105.

## LANDSCAPE AND NATIONAL LEVEL SOLUTIONS FOR A MORE SUSTAINABLE N MANAGEMENT IN DENMARK

DALGAARD, T.<sup>1</sup>, BROCK, S.<sup>2</sup>, CORDOVIL, C.M.S., GRAVERSGAARD, M.<sup>1</sup>, HANSEN, B.<sup>3</sup>, HASHEMI, F.<sup>1</sup>, HASLER, B.<sup>4</sup>, HUTCHINGS, N.J.<sup>1</sup>, JACOBSEN, B.<sup>5</sup>, JENSEN, L.S.<sup>6</sup>, KJELDEN, C.<sup>1</sup>, OLESEN J.E.<sup>1</sup>, SCHJØRRING, J.K.<sup>6</sup>, SIGSGAARD, T.<sup>7</sup>, STUBKJÆR ANDERSEN, P.<sup>8</sup>, TERMANSEN, M.<sup>5</sup>, VEJRE, H.<sup>8</sup>, VESTERGAARD ODGAARD, M.<sup>1</sup>, WIBORG, I.A.<sup>9</sup>

<sup>1</sup> Department of Agroecology, Aarhus University, Blichers Allé 20, DK-8830 Tjele, Denmark. [tommy.dalgaard@agro.au.dk](mailto:tommy.dalgaard@agro.au.dk); <sup>2</sup> Aarhus University, Dept. of Culture and Society, Jens Chr. Skous Vej 7, DK-8000 Aarhus C, Denmark; <sup>3</sup> Geological Survey of Denmark & Greenland – GEUS, C.F. Møllers Allé 8, DK-8000 Aarhus C, Denmark; <sup>4</sup> Aarhus University, Dept. of Environmental Sciences, Frederiksborgvej 399, DK-4000 Roskilde, Denmark; <sup>5</sup> University of Copenhagen, Dept. of Food and Resource Economics, Rolighedsvej 25, DK-1870 Frederiksberg C, Denmark; <sup>6</sup> University of Copenhagen, Dept. of Plant and Environmental Sciences, Thorvaldsensvej 40, DK-1871 Frederiksberg C, Denmark; <sup>7</sup> Aarhus University, Dept. of Public Health, Bartholin Allé 2, 8000 Aarhus C, Denmark; <sup>8</sup> University of Copenhagen, Dept. Geosciences and Natural Resource Management, Rolighedsvej 23, DK-1858 Frb. C, Denmark; <sup>9</sup> SEGES, Knowledge Centre for Agriculture, Agro Food Park 20, DK-8200 Aarhus N, Denmark.

### INTRODUCTION

In 2016, The Danish Government introduced an N-policy paradigm shift with a new regulation tailored to local reduction targets rather than the general, national reduction goals applied in previous action plans. It is a large challenge to implement this and has been a turning point for studies in the DNMARK Research Alliance ([www.dNmark.org](http://www.dNmark.org)) and the related NitroPortugal coordination and support action, presented in this paper. For instance, a new scheme with watershed advisors (“oplandskonsulenter”) has been implemented, inspired by the DNMARK pilot landscape study sites, and the geographically tailored N regulation will be implemented stepwise over the coming years, with significantly increased implementation of measures like wetlands, mini-wetlands, afforestation and other landscape level filters to prevent reactive nitrogen (Nr) from reaching vulnerable recipients. These measures are integrated on top of the existing general regulation, and assessment of the integrated effect is important both at the landscape scale and at the national scale, and is the turning point for solution scenario development at both landscape and national scales.

### MATERIAL AND METHODS

Three different groups of solution (mitigation) scenarios have been explored in the DNMARK alliance: 1) New production chains with more efficient use and recycling of N, 2) Geographically differentiated N-mitigation measures based on planning and management of agricultural landscapes, and 3) Changed consumption patterns driving land use change and reducing N use. The solution scenarios, based on emission factor modelling in line with Hutchings et al. (2014), are evaluated in terms of how they can contribute to and ideally comply with targets agreed for N pollution to surface and groundwater (Water Framework Directive; Nitrates Directive), ammonia volatilization (CAFE) and nitrous oxide (EU climate targets). In addition, the scenarios may depend on their internal logic and the measures adopted can lead to other benefits in terms of effects on biodiversity, nature and ecosystems as well as different types of revenue-generating production.

### RESULTS AND DISCUSSION

In this paper, we present the following selected examples of the above scenario categories:

#### New production chains with more efficient use and recycling of N

- Anaerobic digestion (biogas) of livestock manure (with maize and grass silage added). This results in enhanced N use efficiency of applied manure thereby yielding a lower N leaching and lower N<sub>2</sub>O emissions. However, this may increase ammonia volatilization. Overall, this reduces the need for use of mineral N.
- Acidification of livestock slurry in animal housing for respectively cattle and all livestock. This will substantially reduce ammonia volatilization, which enhances the content of mineral N in the manure

applied in the field. This may reduce the need for use of mineral N fertilizer. This will not in itself reduce N leaching, but if combined with use of nitrification inhibitors, in some cropping systems and soil types, there may be a possibility to reduce N leaching during spring time (in particular for N applied to silage maize and potatoes).

Table 1. Examples on results from the national solution scenarios on new production chains with a more efficient use and recycling (Anaerobic digestion (biogas) of livestock manure, and acidification of livestock slurry).

	Emissions reductions (% change)			Applied N in field (% change)		
	NO <sub>3</sub>	NH <sub>3</sub>	N <sub>2</sub> O	Fertilizer	Manure	Total
Biogas	-11.4	7.3	-12.6	-21.0	12.4	1.3
Acidification (cattle)	0.3	-18.3	-0.7	-4.7	2.0	-0.2
Acidification (all)	0.6	-49.1	-0.4	-18.9	8.9	-0.3

### Geographically differentiated N-measures based on planning and management of agricultural landscapes

The focus of geographically differentiated N mitigation measures relate to the different susceptibilities of aquatic ecosystems (groundwater, fresh water and marine systems) to N loading across the landscape and to differences in the capacity of landscape components to reduce nitrate to N<sub>2</sub> (groundwater and surface water). The possibilities of applying differentiated N-measures depend highly on the scale at which these are applied, since both vulnerability and N reduction varies greatly across the landscape. In this study the focus was on applying measures (set-aside) for reducing N loadings to the marine environment in Denmark. The N-loading was calculated from the N leaching from the root zone corrected for N reducing in groundwater and surface waters. The effect was assessed by evaluating the area needed to comply with the Water Framework Directive targets for maximum load to individual marine environments. Three different criteria for targeting the placement of set-aside were evaluated: N reduction in groundwater and surface waters, naturalness (biodiversity) of the landscape, and land value.

### Changed consumption patterns driving land use change and reducing N use

Changes in both local and global consumption (and production) patterns will affect N use and N losses in Danish agriculture. For this, we considered two alternative food demand scenarios, which are likely to have an impact on agricultural production, land use and nitrogen balances in Denmark: 1) A changed global consumption scenario, and 2) A local consumption scenario. The first scenario represents a change in the export demand for Danish agricultural products (including the extent to which production to the domestic market will have to adapt to a changed export demand). In contrast, the second scenario represents a change in the domestic food demand behavior and the resulting changes in exports that may follow from this change, given the total area available for agricultural production.

**Acknowledgements:** To Innovation Fund Denmark for support to the [www.dNmark.org](http://www.dNmark.org) Research Alliance, and to the EU Commission for support to the NitroPortugal H2020 Twinn-2015 Coordination and Support Action.

### REFERENCE

- Dalgaard T, Hansen B, Hasler B *et al.*, 2014. Policies for agricultural nitrogen management - trends, challenges and prospects for improved efficiency in Denmark. *Environ. Res. Lett.* 9, 115002.
- Hutchings N, Nielsen O, Dalgaard T *et al.* 2014. A nitrogen budget for Denmark; developments between 1990 and 2010, and prospects for the future. *Environ. Res. Lett.* 9, 115012.

## **CONTROLLED TRAFFIC FARMING INCREASES ROOT GROWTH, CROP AND SOIL NITROGEN IN VEGETABLE CROPPING SYSTEMS**

HEFNER, M.<sup>1</sup>, LABOURIAU, R.<sup>2</sup>, NØRREMARK, M.<sup>3</sup>, KRISTENSEN, H.L.<sup>1</sup>

<sup>1</sup> Department of Food Science, Aarhus University, Denmark; <sup>2</sup> Department of Mathematics, Aarhus University, Denmark; <sup>3</sup> Department of Engineering, Aarhus University, Denmark

### **INTRODUCTION**

Problems of machinery induced soil compaction are evident in crop production, resulting in changes of nitrogen (N) availability, restricted root growth and reduced yields (Batey & McKenzie, 2006). Controlled traffic farming (CTF) uses GPS signals to keep machine traffic in permanent lanes, which restricts soil compaction to wheel tracks. In our study we compared effects of CTF to random traffic farming (RTF) on root growth, soil N mineralization, N uptake and crop yield, in organic vegetable cropping systems across two soil types in Denmark after a period of two years since establishment. Our hypotheses were that CTF will in contrast to RTF (1) improve root growth, (2) not affect N mineralization and (3) increase crop yield and N uptake.

### **MATERIAL AND METHODS**

Field experiments were conducted at two commercial organic farms in Denmark from 2013 to 2016. The farm of Skifteker Økologi (54°58'N, 10°32'E) was situated on a fine sandy loam and the farm of Vostrup Øko (55°89'N, 8°45'E) on a coarse sandy soil. CTF was compared to RTF as the control (n=3). CTF was carried out with auto-guidance and highly accurate RTK-GPS (Real Time Kinematic). Machinery traffic in the CTF plots was restricted to permanent tracks contrary to machinery traffic in the RTF plots. Crop samples were analysed for marketable yields, total biomass and N content to calculate N accumulation; and soil mineral N. Potential soil N mineralization was studied by incubating top soil samples at 25°C for 35 days. Root growth was registered by filming by use of minirhizotrons reaching 1.5 or 2.5 m depth (Xie & Kristensen, 2017). The number of roots was calculated as root intensity and tested by fitting to a Poisson distribution including a random component and adding an offset to improve the statistical analysis. This resulted in an arbitrary (no) unit.

The 5-year crop rotation at Skifteker Økologi was red clover – white cabbage – potato followed by vetch as a winter cover crop – beetroot – winter squash. The experimental design included the full crop rotation in adjacent fields each year. Three out fields per treatment were sampled each year, being at the same GPS position within the bed throughout the experiment. At Vostrup Øko the 4-year crop rotation was grass-clover – carrot – potato – beetroot with a similar design as at Skifteker, but only growing one crop each year.

### **RESULTS AND DISCUSSION**

Crops had more roots at harvest especially in the deep part of the root zone in four out of the six crop seasons at Skifteker Økologi, that is, in white cabbage and potato in 2015 and in beetroot and winter squash in 2016 (Figure 1). At Vostrup Øko more roots were found under beetroot in 2015 (data not shown). N accumulation was higher in CTF treatments in white cabbage and potato in 2015, but not in beetroot in 2015 or in 2016 at Skifteker Økologi. The difference was not significant at Vostrup Øko (Table 1). Yields at the two farms followed the same pattern as the N accumulation (data not shown). Soil mineral N was higher below CTF for some crops, whereas potential mineralization of N did not differ between CTF and RTF treatments (data not shown). These results indicate a positive effect of CTF on crop yields, root growth and N accumulation already 2 and 3 years after conversion from RTF at Skifteker Økologi on a fine sandy loam. However, the effect was not evident every year or clearly linked to crop species. At Vostrup Øko on coarse sandy soil, the effect of CTF was significant only on root growth.

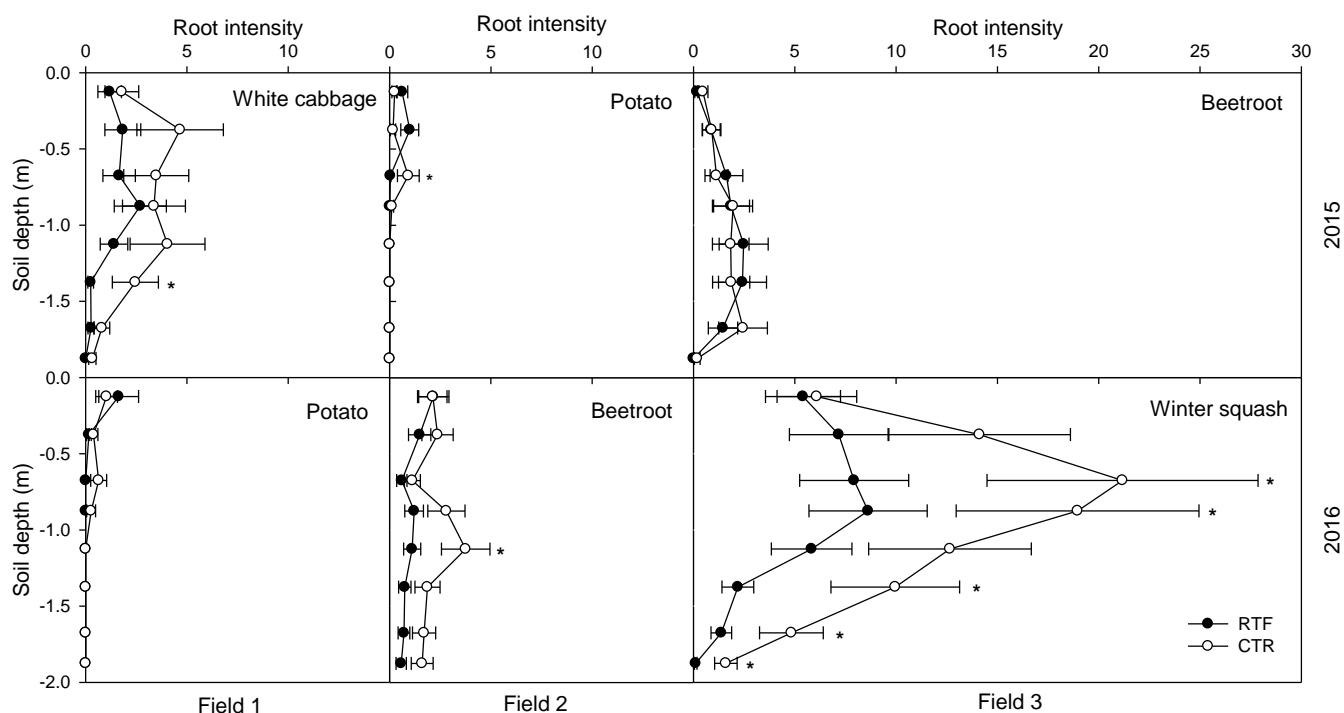

Figure 1. Root intensity at Skiftevær Økologi in 0 to 2 m depth at crop harvest in the sampled fields in 2015 and 2016. Bars show 95% confidence intervals. \* indicate significant difference between treatments at  $p < 0.05$ .

Table 1. Nitrogen accumulation ( $\text{kg ha}^{-1}$ ) in the aboveground plant parts at Skiftevær Økologi (Fields 1-3) and Vostrup Øko. Confidence intervals at 95% are shown. Different letters indicate difference between treatments at  $p < 0.05$ .

Treatment	Field 1	Field 2	Field 3	Vostrup
<b>2015</b>	White cabbage	Potato	Beetroot	Beetroot
CTF	142 (131-153) <sup>a</sup>	153 (134-172) <sup>a</sup>	87 (74-101) <sup>a</sup>	113 (87-139) <sup>a</sup>
RTF	116 (105-127) <sup>b</sup>	92 (73-111) <sup>b</sup>	71 (57-84) <sup>a</sup>	87 (61-113) <sup>a</sup>
<b>2016</b>	Potato	Beetroot	Winter squash	
CTF	51 (33-69) <sup>a</sup>	72 (54-91) <sup>a</sup>	68 (50-87) <sup>a</sup>	-
RTF	52 (34-70) <sup>a</sup>	68 (49-86) <sup>a</sup>	48 (30-66) <sup>a</sup>	-

## CONCLUSION

CTF increased root growth, yields and N accumulation in several vegetable crops in an organic crop rotation on sandy loam and increased root growth on sandy soil. The results underline the potential of CTF to improve yields and N use efficiency in organic vegetable production.

**Acknowledgements:** The project was funded by the Green Growth and Development programme (GUDP) under the Danish Ministry of Environment and Food and participants in the project ORGANICS IN THE TRAIL.

## REFERENCES

- Batey T., McKenzie D.C. 2006. Soil compaction: identification directly in the field. *Soil Use and Management* 22, 123-131.
- Xie Y., Kristensen H.L. 2017. Intercropping leek (*Allium porrum*) with dyer's woad (*Isatis tinctoria*) increases rooted zone and agro-ecosystem retention of nitrogen. *European Journal of Agronomy* 82, 21-32.

## EVALUATING THE POTENTIAL OF DIETARY CRUDE PROTEIN MANIPULATION IN REDUCING AMMONIA EMISSIONS FROM CATTLE AND PIG MANURE

AMON, B.<sup>1</sup>, E.P.M, SAJEEV.<sup>2</sup>, ZOLLITSCH, W.<sup>3</sup>, AMMON, C.<sup>1</sup>, WINIWARTER, W. <sup>4,5</sup>

<sup>1</sup> Leibniz Institute for Agricultural Engineering and Bioeconomy (ATB), Germany; <sup>2</sup> Institute of System Sciences, Innovation and Sustainability Research and FWF-DK Climate Change, University of Graz, Austria; <sup>3</sup> Division of Livestock Sciences, Department of Sustainable Agricultural Systems, University of Natural Resources and Life Sciences (BOKU), Austria; <sup>4</sup> International Institute for Applied Systems Analysis (IIASA), Austria; <sup>5</sup> Institute for Environmental Engineering, University of Zielona Góra, Poland

### INTRODUCTION

Manure management is a prominent source of NH<sub>3</sub> emissions within the livestock sector (UNECE 2016). Various studies have described and quantified the potential of abatement options to reduce NH<sub>3</sub> emissions from manure management (Bittman et al. 2014). The manipulation of CP in animal diets is one such abatement technique to reduce NH<sub>3</sub> emissions from manure management. The reduction of CP in animal diets has been described and recommended as one of the most cost effective and strategic ways to reduce NH<sub>3</sub> emissions from manure management in Annex IX to the Gothenburg protocol (UNECE 2015), as well as in the recent guidance document on NH<sub>3</sub> abatement (Oenema et al. 2014).

NH<sub>3</sub> emission reductions from dietary manipulation of animal diets have been quantified using measured and reported NH<sub>3</sub> emissions from experimental studies (Hou et al. 2015; Oenema et al. 2014). However, there exists considerable variability in the reported emission reduction estimates. This is mainly because these studies do not distinguish between animal types and also discounts for the underlying factors that affect emissions of NH<sub>3</sub> from reduced CP in animal diets. This highlights the need to better quantify the influence of reduced CP on NH<sub>3</sub> emissions, while distinguishing for animal types and also accounting for a range of factors which may influence NH<sub>3</sub> emissions.

This paper aims to address this research gap by presenting a comprehensive analysis of NH<sub>3</sub> emission reductions from lowering CP content in animal diets. The results discussed here examine the relationship between reduced CP and NH<sub>3</sub> emissions distinguishing between cattle and pigs. The results also explore the effect of reduced CP on total ammoniacal nitrogen (TAN) and of the initial and final CP levels on NH<sub>3</sub> emission reductions. Furthermore, the study also analyses the effect of additional factors such as manure management stages and animal categories on NH<sub>3</sub> emission reductions. The conclusions suggest the need to investigate further questions which would form the basis for discussions at the conference.

### MATERIAL AND METHODS

Our study used a meta-analysis to quantify and compare the effect of a reduction in CP on NH<sub>3</sub> emissions for both cattle and pigs (Sajeev et al. 2017). Since a reduction of CP content in animal diets affects all phases of the manure management chain, we considered emissions from urine and faeces excreted in animal houses, during their storage, and their application to agricultural soils. The emission reductions were calculated relative to the NH<sub>3</sub> emissions during reference CP treatments. Regression analysis was used to determine the relationships between NH<sub>3</sub> emission reductions, TAN reductions and the CP traits (CP reductions, initial CP and final CP levels) along with their associated interactions.

### RESULTS

Results indicate higher mean NH<sub>3</sub> reductions of 17 ± 6% per %-point CP reduction for cattle as compared to 11 ± 6% for pigs. Statistically significant relationships exist between the level of CP reduction, NH<sub>3</sub> emissions and TAN content in manure for both pigs and cattle, with cattle revealing higher NH<sub>3</sub> reductions and a clearer trend in relationships. Manure management stages and pig categories did not indicate a significant influence on NH<sub>3</sub> emission reductions. The results presented help to accurately quantify the effects of NH<sub>3</sub> abatement following

reduced CP levels in animal diets distinguishing between animal types and other physiological factors. This is useful in the development of emission factors associated with reduced CP as an NH<sub>3</sub> abatement option during manure management.

## CONCLUSION AND DISCUSSION

The higher NH<sub>3</sub> reductions in cattle as presented in this study highlight the opportunity to extend concepts of feed optimization from pigs and poultry to cattle production systems to further reduce NH<sub>3</sub> emissions from livestock manure. This is attributed to the greater attention given to optimization of protein supply in pigs relative to cattle and also due to the specific physiology of ruminants to efficiently recycle nitrogen in situations of low protein intake.

The results presented opens up a set of further research questions. The authors would like to use the Nitrogen Workshop as a forum to discuss these questions. For instance: (i) What is the current level of implementation of reduced CP in animal diets as an NH<sub>3</sub> abatement option? (ii) What are the factors that influence the level of implementation of reduced CP in animal diets? (iii) What are the practical implications of lowering CP in cattle diets? Would there be any effect on milk production, meat gain and quality? (iv) How can we incorporate these results in to an emission inventory? (v) Does lowering CP in ruminant diets to abate NH<sub>3</sub> emissions have an influence on methane (CH<sub>4</sub>) emissions from enteric fermentation? If so, can these interactions be quantified?

**Acknowledgements:** E.P.M. Sajeev was supported by the Austrian Science Fund (FWF) under research grant W 1256-G15 (Doctoral Programme Climate Change – Uncertainties, Thresholds and Coping Strategies).

## REFERENCES

- Bittman, S., M. Dedina, C. Howard, O. Oenema, and M. Sutton. 2014. Options for ammonia mitigation: Guidance from the UNECE Task Force on Reactive Nitrogen. Centre for Ecology and Hydrology, Edinburgh, UK. [http://www.clrtap-tfrn.org/sites/clrtap-tfrn.org/files/documents/AGD\\_final\\_file.pdf](http://www.clrtap-tfrn.org/sites/clrtap-tfrn.org/files/documents/AGD_final_file.pdf). Accessed 24 October 2017.
- Hou, Y., G. L. Velthof, J. P. Lesschen, I. G. Staritsky, and O. Oenema. 2017. Nutrient recovery and emissions of ammonia, nitrous oxide and methane from animal manure in Europe: effects of manure treatment technologies. *Environ Sci Technol* 51: 375-383.
- Sajeev EPM, Amon B, Ammon C, Zollitsch W, Winiwarter W (2018) Evaluating the potential of dietary crude protein manipulation in reducing ammonia emissions from cattle and pig manure: A meta-analysis *Nutrient Cycling in Agroecosystems*: 110,161-175
- Oenema, O., S. Tamminga, H. Menzi, A. Aarnik, and C. Pineiro. 2014. Livestock feeding strategies. In: Bittman, S., et al., (eds), Options for Ammonia Mitigation: Guidance from the UNECE Task Force on Reactive Nitrogen, Convention on Long Range Transboundary Air Pollution. Centre for Ecology and Hydrology, Edinburgh, UK. p. 10-13. [http://www.clrtap-tfrn.org/sites/clrtap-tfrn.org/files/documents/AGD\\_final\\_file.pdf](http://www.clrtap-tfrn.org/sites/clrtap-tfrn.org/files/documents/AGD_final_file.pdf). Accessed on 24 Oct. 2017
- UNECE. 2015. Methane and ammonia air pollution. Policy Brief prepared by the UNECE Task Force on Reactive Nitrogen. Task Force on Reactive Nitrogen, Working Group on Strategies and Review of the UNECE Convention on Long-range Transboundary Air Pollution, Aarhus, DK. <http://www.clrtap-tfrn.org/content/methane-and-ammonia-air-pollution>. Accessed on 24 October 2017.
- UNECE. 2016. Convention of Long-Range Transboundary Atmospheric Pollution, United Nations Economic Communication for Europe, Geneva, Switzerland. <http://ec.europa.eu/eurostat/web/environment/air-emissions-inventories/database>. Accessed on 16 November 2016.

## SUPPORTING TRANSITION TO LOW INPUTS PRODUCTION SYSTEMS: ECONOMIC AND ENVIRONMENTAL ASSESSMENT

DEVIIENNE S.<sup>1</sup>, VERTES F.<sup>2</sup>, GARAMBOIS N.<sup>1</sup>, AKKAL-CORFINI N.<sup>2</sup>, DURAND P.<sup>2</sup>, PARNAUDEAU V.<sup>2</sup>

<sup>1</sup> AgroParisTech, UFR Agriculture comparée, UMR Prodig, France; <sup>2</sup> INRA Agrocampus Ouest, UMR SAS, France.

### INTRODUCTION

Livestock farming is an essential activity in many rural areas. When concentrated in intensive highly productive areas (such as Brittany, NL, DK) it is known to generate both positive services and negative impacts (Dumont et al., 2016), in particular on water, air and soil quality, that imply the need for further evolution toward more sustainable agriculture. How to support transition to sustainable farming at farm and territory scales was the question, applied to a case study (Blavet watershed, Brittany, France), by building possible scenario with local stakeholders and assessing their environmental and socio-economic consequences at both scales. We identified connections between production systems and risky nitrogen agricultural practices and explored potential ways to reduce the environmental impact of farms while respecting their economic viability and technical feasibility of changes.

### MATERIAL AND METHODS

The Blavet river drains a 2090 km<sup>2</sup> watershed located on granitic (west) with slopes and abrupt relief or shale (east) substrates with flat to moderate slopes. Agricultural areas represent about 70% of the total area, with 3700 farms. Dairy production dominates in the north and western part (granite and/or rainy climate) while the median eastern part with higher agricultural potentialities crop (including vegetables) production, being predominant, is mostly combined with dairy, pig or poultry production.

The technical-economic assessment was realised using the agrarian diagnosis method (Cochet and Devienne, 2006) at regional scale, to identify the different types of production systems according to the present and past means of production, thanks to farm surveys. Each production system was characterized as a combination of cropping and livestock systems, whose function logic was explained and economic results assessed and modelled. The N leaching risk of the different cropping systems was assessed by i) calculating annual soil N surplus modulated by a leaching risk coefficient based on soil cover during winter (from 30% under grassland to 100% under bare soil) and ii) Syst'N model (Parnaudeau *et al.*, 2012) for a subsample of farming systems and corresponding cropping systems. Principal component analysis was used to identify clusters of crop rotation x leaching risks, on the cropping systems described in the Blavet data basis from enquiries

Each “conventional” production systems (in a first step dairy cattle specialized or mixed with cash crop production) was then related to an economic/autonomous one (EA), based on agro-ecological principles and/or involved in organic farming, in the context of similar production means and soil-climate conditions. In order to model the redesigning of production systems, we conducted an in-depth study of agro-ecological systems currently present in the region. Results presented here focus on economic and N losses assessment for a conventional dairy system and a possible thriftier and more autonomous alternative.

### RESULTS AND DISCUSSION

**1. General results for the Blavet watershed:** 40 types of production systems (including 19 dairy production systems, 4 of which being EA alternative systems) were identified and characterized. About 630 cropping systems were distributed in 14 clusters crossing a 1<sup>st</sup> gradient “crop succession with grasslands or not” and a 2<sup>nd</sup> one corresponding to a N leaching risk gradient (mean values of clusters between 5 and 80 kgN-NO<sub>3</sub>.ha<sup>-1</sup>.yr<sup>-1</sup>) and “vegetables or not”. If dairy production systems differ depending on land type and herd size, which is correlated with equipment level, they share a common forage system operating logic, maize playing a key role in the process



of milk output growth. Depending on the location (shale or granite, wide or narrow interfluvium) the share of arable land and maize yields are more or less important as much as the place of maize in the ration (5 to 3 kg per day during grazing season; 90% to 2/3 of the ration in the winter) and the milk yield (9,500-10,000l to 7500-8000l per cow). Inequalities of access to land and equipment lead to large income disparities, with a growing number of economically fragile production systems in the current context of dairy crisis. Cropping systems linked to dairy production systems were distributed in 11/14 clusters (all < 70 kgN-NO<sub>3</sub>.ha<sup>-1</sup>.yr<sup>-1</sup>).

## 2. Possible transition for one type of dairy farming system: technical, economic and N emissions assessments

We highlight here an example of transition of a dairy production system (DC1) to an EA system (DCEA1) based on grass-legume grasslands without N fertilizer and mostly grazed, with a rotational grazing system. Despite lower milk yields and production, the drastic decrease of inputs and equipment use allows increased economic performances (value-added and income) and lower N emissions, thanks also to better soil cover in winter.

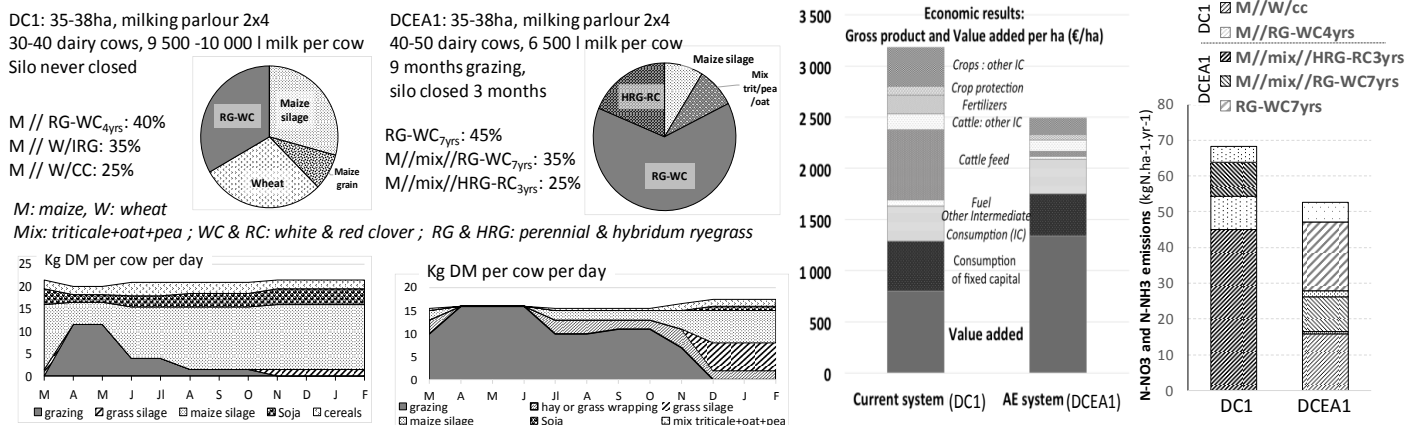

Figure 1: Comparison of DC1 and DCEA1 on technical, economical and N emissions (Syst'N results, hatched areas = N-NO<sub>3</sub> leached, dotted areas = N-NH<sub>3</sub> volatilised)

## CONCLUSION

The agrarian diagnosis coupled with environmental assessment at farm and watershed scales is based on the analyses of local agricultural systems, in their specific biophysical and socio-economic conditions. Redesign is built using knowledge of agro-ecological systems types as declined by local farmers, and can thus be used to decline changing scenario at territory scale. It was applied on dairy production and crop (including industry vegetables) production systems, before to be extended to other productions. In all cases, coupling improvement in both economic and environmental results led to highlight the conditions favoring transitions and to demonstrate that farmers may find it economically advantageous to adopt systemic changes based on agro-ecological principles allowing lower N emissions. Ongoing work will precise territorial impacts of changes at large scale on regional economic and social issues, as well as on N fluxes at watershed scale, while some other impacts or ecosystem services linked to current and alternative production systems will be assessed.

**Acknowledgements:** ANR for Escapade funding, Brittany region and AE Loire-Bretagne for Creseb-Blavet funding

## REFERENCES

Dumont B. (coord), Dupraz P. (coord.) et al., 2016. Rôles, impacts et services issus des élevages en Europe. Synthèse de l'expertise scientifique collective, INRA (France), 126 p.

Parnaudeau V., Reau R., Dubrulle P., 2012. Un outil d'évaluation des fuites d'azote vers l'environnement à l'échelle du système de culture: le logiciel Syst'N. Innovations Agronomiques 21, 59-70.

Cochet H, Devienne S., 2006. Fonctionnement et performances économiques des systèmes de production agricole: une démarche à l'échelle régionale. Cahiers Agriculture n°6, nov-déc 2006.

## ORGANIC N FERTILIZATION EFFECTS ON PASTURE ESTABLISHMENT AND FOREST FIRE PREVENTION

FERREIRO-DOMINGUEZ N<sup>1,2</sup>, RODRIGUEZ-RIGUEIRO J<sup>1</sup>, RIGUEIRO-RODRIGUEZ A<sup>1</sup>, MOSQUERA-LOSADA MR<sup>1</sup>

<sup>1</sup> Department of Crop Production and Engineering Projects, Escuela Politécnica Superior de Lugo, University of Santiago de Compostela, Campus Universitario s/n, 27002 Lugo, Spain <sup>2</sup> Forest Research Centre, School of Agriculture, University of Lisbon, Tapada da Ajuda s/n, 1349-017 Lisbon, Portugal

### INTRODUCTION

Soil fertility is key to ensure high pasture production. Lime and fertilizers usually improves soil chemical properties in acid soils, enhancing herbaceous pasture establishment instead of woody understory vegetation in silvopastoral systems, once established harvest that promotes fire risk and causes people death in South Europe. Once established, grazing or harvesting maintains the dominance of the herbaceous component in the silvopastoral system (Mosquera-Losada et al. 2006). Liming and fertilization also helps to maintain botanical composition of sown grasslands, leading to a better animal grazing and production and, in Galicia, to a clear reduction of forest fire risk. Increasing fertility is usually based on mineral fertilizers that are currently costly for both farmers and the environment due to fertilizer production and transport. Thus, using organic fertilizers easily available and close to the farm should be promoted. Municipal sewage sludge (SS) is a good option to increase pasture production and enhance soil pH of acid soils in Galicia (Mosquera-Losada et al., 2010), but could cause some harmful to the environment due to higher proportion of heavy metals SS has compared with soil, which needs to be evaluated at long term. This study aims at evaluating the effect of three doses of SS (160, 320 and 480 kg total N ha<sup>-1</sup>) combined or not with lime, on the botanic pasture composition, compared with control treatments (no fertilisation (NF) and mineral fertilisation (MIN)) during twelve years in a silvopastoral system established under *Pinus radiata* D. Don in Galicia.

### MATERIAL AND METHODS

The study was conducted in Pol (Lugo, Galicia, NW Spain) in a plantation of *Pinus radiata* D. Don established in 1993 (1667 trees ha<sup>-1</sup>). In autumn of 1997, an experiment with a randomised block design was carried out in 27 experimental plots (9 treatments x 3 replicates) of 96 m<sup>2</sup>. Each plot was sown with a mixture of *Lolium perenne* L., *Dactylis glomerata* L. and *Trifolium repens* L. after ploughing. All plots were initially fertilised with 120 kg P<sub>2</sub>O<sub>5</sub> ha<sup>-1</sup> and 200 kg K<sub>2</sub>O ha<sup>-1</sup>. The nine treatments were: three SS doses (160 (L1), 320 (L2) and 480 (L3) kg total N ha<sup>-1</sup>) with or without liming applied in 1997 before sowing (2.5 t CaCO<sub>3</sub>ha<sup>-1</sup>) applied in 1998, 1999 and 2000, a no fertilization (NF) treatment as unfertilized control in the limed and unlimed plots and a mineral treatment (MIN) control in the unlimed plots (500 kg of 8% N – 24% P<sub>2</sub>O<sub>5</sub> – 16% K<sub>2</sub>O ha<sup>-1</sup> and year from 1998 to 2003). . To evaluate the residual effect of SS treatments, the same mineral fertiliser doses were added in 2001, 2002 and 2003 in the previously SS fertilised plots. The botanical composition of the pasture was estimated by random sampling of pasture (4 per plot, each 0.3 × 0.3 m<sup>2</sup>) during spring and winter from 1998 to 2012. Samples included pine needles on soils and were separated into the different species by hand in the laboratory. This study shows the data obtained in spring 1998, 2004 and 2012. The data were analysed using ANOVA (proc glm procedure). Means were separated by using LSD test, if ANOVA was significant.

### RESULTS AND DISCUSSION

Pasture production was reduced from the beginning to the end of the experiment. Shortly after being sown (1998), both *Trifolium* and *Lolium* responded positively to liming, and *Lolium* was better established when liming was combined with L3. *Trifolium repens* L. and *Lolium perenne* L. were generally better established in limed and SS fertilized plots (Figure 1) as these treatments improve soil fertility, pasture productivity and quality (Mosquera-Losada et al., 2009) probably due to the pH increase (Bailey, 1995). *Dactylis* response was better when higher SS doses (480 kg N ha<sup>-1</sup>) were applied but disappeared after 2004 in both the unlimed NF and the MIN plots. Both *Lolium* and *Trifolium* disappeared in all treatments four years after the last SS fertilization, probably due to the

high water soil acidity (4.5) and to the increase of canopy cover caused by the Pine growth. Spontaneous vegetation, including weeds and shrubs, was in a greater proportion in control treatments (NF) compared to SS treatments enhancing more fertility demanding sowed species. The larger proportion of major shrubs (i.e. gorse) is usually linked to a high fire risk, as shown by different studies indicating that an increase in soil fertility can change the botanical composition of the understory by highly decreasing flammable shrub species (Ferreiro-Domínguez et al., 2014). Other species are mainly associated to spontaneous pasture species (i.e. *Agrostis* spp..) with low feed quality. The higher proportion of needles replacing the pasture obtained in SS fertilized plots could be explained by the trees enhanced growth, whose canopy cover prevented solar radiation to attain the lower stratum, limiting the decomposition and mineralization due to low temperatures and increasing the needle accumulation in the top soil.

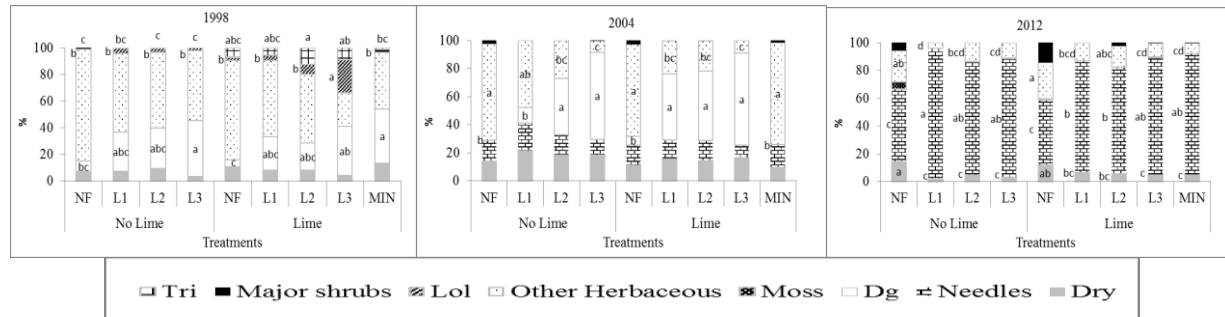

Figure 1. Botanical composition under different treatments in 1998, 2004 and 2012, where NF: no fertilization; L1: low SS dose ( $160 \text{ kg N ha}^{-1}$ ); L2: medium SS dose ( $320 \text{ kg N ha}^{-1}$ ); L3: high SS dose ( $480 \text{ kg N ha}^{-1}$ ); MIN:  $500 \text{ kg ha}^{-1}$  of 8:24:16; Dg: *Dactylis glomerata* L.; Lol: *Lolium perenne* L.; Tri: *Trifolium repens* L.; Dry: senescent material.

## CONCLUSION

Sewage sludge favoured the establishment of sown species increasing pasture quality and reducing the fire risk. Thinning should be carried out to enhance pasture production and reduce needle accumulation in the top soils once canopy cover is complete.

**Acknowledgements:** We are grateful to XUNTA DE GALICIA (Consolidation funds and Consellería de Cultura, Educación e Ordenación Universitaria (“Programa de axudas á etapa posdoutoral DOG nº122, 29/06/2016 p.27443, exp: ED481B 2016/0710”)).

## REFERENCES

- Bailey, J.S., 1995. Liming and nitrogen efficiency: Some effects of increased calcium supply and increased soil pH on nitrogen recovery by perennial ryegrass. *Commun. Soil Sci. Plant Anal.* 26, 1233–1246.
- Ferreiro-Domínguez, N., Rigueiro-Rodríguez, A., Bianchetto, E., Mosquera-Losada, M.R., 2014. Effect of lime and sewage sludge fertilisation on tree and understory interaction in a silvopastoral system. *Agric. Ecosyst. Environ.* 188, 72–79. <https://doi.org/10.1016/J.AGEE.2014.02.007>
- Mosquera-Losada, M.R., López-Díaz, M.L., Rigueiro-Rodríguez, A., 2009. Zinc and copper availability in herbage and soil of a *Pinus radiata* silvopastoral system in Northwest Spain after sewage-sludge and lime application. *J. Plant Nutr. Soil Sci.* 172.
- Mosquera-Losada, M.R., McAdam J., Rigueiro-Rodríguez, A., 2006. *Silvopastoralism and sustainable land management*. CABinternational.
- Mosquera-Losada, M.R., Muñoz-Ferreiro, N., Rigueiro-Rodríguez, A., 2010. Agronomic characterisation of different types of sewage sludge: Policy implications. *Waste Manag.* 30, 492–503.

## PASTURE PRODUCTION IN A SILVOPASTORAL SYSTEM ESTABLISHED WITH *JUGLANS REGIA* L. AND FERTILIZED WITH SEWAGE SLUDGE

MOSQUERA-LOSADA, M.R.<sup>1</sup>, ARIAS-MARTINEZ, D.<sup>1</sup>, RIGUEIRO-RODRÍGUEZ A<sup>1</sup>, FERREIRO-DOMINGUEZ, N.<sup>1, 2</sup>

<sup>1</sup> Department of Crop Production and Engineering Projects, Escuela Politécnica Superior de Lugo, University of Santiago de Compostela, Campus Universitario s/n, 27002 Lugo, Spain; <sup>2</sup> Forest Research Centre, School of Agriculture, University of Lisbon, Tapada da Ajuda s/n, 1349-017 Lisbon, Portugal

### INTRODUCTION

Nitrogen can be applied to the soil through inorganic and organic fertilisers. Inorganic fertilisers are costly from both economic and environmental points of view. The use of sewage sludge (SS) as organic fertiliser is encouraged by the European Community since it can have valuable agronomic properties (EU, 1986), but SS can have higher levels of heavy metals than the soil, which could be a risk. In Europe, SS should be stabilised before applying it into the soils. The main forms of stabilisation are anaerobic digestion, compost and pelletisation. Silvopastoral systems, which are characterized by integrating woody vegetation with forage and livestock production in the same area, can modify the pasture production by the fertilisation with SS but also by the tree density (Mosquera-Losada et al., 2011). The aim of this study was to evaluate the effect of three types of SS (anaerobic, composted and pelletised) on pasture production compared with control treatments (no fertilisation and mineral fertilisation) in a silvopastoral system established under *Juglans regia* L. at different densities (277 and 625 trees ha<sup>-1</sup>).

### MATERIAL AND METHODS

The study was conducted in A Mota (Boimorto, A Coruña, Spain) with an Atlantic climate. At the beginning of the experiment soil pH was acidic (6.28), the texture loam and the bulk density 984.24 kg m<sup>-3</sup>. In 2013, the plot was planted with *J. regia* L. at low (LD: 277 trees ha<sup>-1</sup>) and high tree density (HD: 625 trees ha<sup>-1</sup>) and sown with *Dactylis glomerata* L., *Lolium perenne* L. and *Trifolium repens* L. The experimental design was randomized blocks, with three replicates and five fertilisation treatments per each tree density. Treatments consisted of no fertilisation (NF), mineral fertilisation (MIN) with 500 kg of 8% N – 24% P<sub>2</sub>O<sub>5</sub> – 16% K<sub>2</sub>O ha<sup>-1</sup> and year and fertilisation with anaerobic (ANA), composted (COM) and pelletised (PEL) SS (320 kg total N ha<sup>-1</sup>) before tree planting and a second application of MIN in February 2015 (250 kg of 10% N – 10% P<sub>2</sub>O<sub>5</sub> – 20% K<sub>2</sub>O ha<sup>-1</sup> and year). The plots were grazed by sheep in a continuous stocking system. Pasture production was estimated by taking several samples of pasture per plot within an exclusion cage of 1 m<sup>2</sup> from 2014 to 2017. The samples were weighed in fresh in the field and a sub-sample was taken to the laboratory, weighed and dried (48 hours at 60°C) and weighed again to determine the dry matter production. Annual pasture production in 2015 and 2016 was calculated by summing all harvests in each year. The data were analysed using a repeated measures ANOVA (proc glm procedure). Means were separated by using LSD test if ANOVA was significant (SAS, 2001).

### RESULTS AND DISCUSSION

In this experiment, in both tree densities, pasture production was higher in the 2015 harvest than in 2016 ( $p < 0.001$ ) probably because, despite being 2015 a dry year in general, the mean temperature in 2015 was only 1 °C higher than the last 30 years mean temperature compared with the difference of 16 °C higher of 2016. In any case, the pasture production of this study was similar to the pasture production estimated by Mosquera-Losada et al. (2011) in a similar area. Throughout the study period, the pasture production was significantly higher in LD than in HD (LD: 13.93<sup>a</sup> and HD: 12.68<sup>b</sup> as Mg ha<sup>-1</sup>) (different superscript letters indicate significant differences between tree densities) ( $p < 0.01$ ). This result could be explained by the higher shade generated by trees and the higher competition by water and nutrients between trees and pasture in HD than in LD, which indicates that tree thinning would probably help to increase the pasture production in HD. Finally, under trees established at LD, the fertilisation treatments significantly modified the pasture production in April 2015 and August 2017 harvests ( $p < 0.05$ ) (Figure 1). In April 2015, pasture production was higher in –ANA and COM than in NF, and PEL probably

because ANA COM implies higher inputs of organic matter into the soil, due to its low nitrogen content, that could increase water availability (Mosquera-Losada et al., 2010). However in August 2017, pasture production generally increased with PEL and ANA compared with the other treatments, probably because PEL and ANA increases the availability of N into the soil, and also the liberation of cations (Mosquera-Losada et al., 2010). In the case of the HD, results tended to be similar to those observed in LD (data not shown).

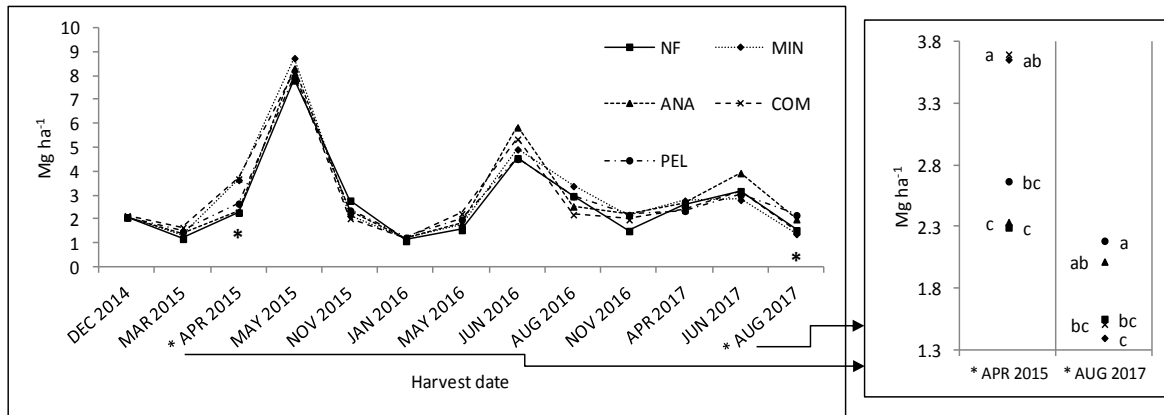

Figure 8: Pasture production (Mg dry matter ha<sup>-1</sup>) in all treatments under low tree density (LD). The right chart shows the production in the two harvests with significant differences. NF: no fertilisation, MIN: mineral; ANA: anaerobic sludge; COM: composted sludge and PEL: pelletised sludge. \* indicates that in that harvest there were significant differences between treatments. Different letters indicate significant differences between fertiliser treatments in each harvest.

## CONCLUSION

Pasture production was increased with low tree densities and influenced by the type of fertilization when weather conditions allowed it. COM and ANA use to have higher production during spring due to the organic matter they provide, that increases drought deficiencies resilience, while in summer PEL is the type of fertilization that better performs in terms of pasture production. The use of sewage sludge improves the agronomic benefits compared with NF and promoting bioeconomy while solving problems of residue management.

**Acknowledgements:** We are grateful to XUNTA DE GALICIA (Consolidation funds and Consellería de Cultura, Educación e Ordenación Universitaria (“Programa de axudas á etapa posdoutoral DOG nº122, 29/06/2016 p.27443, exp: ED481B 2016/0710”)).

## REFERENCES

- EU, 1986. Council Directive 86/278/EEC of 12 June 1986 on the protection of the environment, and in particular of the soil, when sewage sludge is used in agriculture, 181.
- Mosquera-Losada, M.R., Morán-Zuloaga, D., Rigueiro-Rodríguez, A., 2011. Effects of lime and sewage sludge on soil, pasture production, and tree growth in a six-year-old *Populus canadensis* Moench silvopastoral system. *J. Plant Nutr. Soil Sci.* 174, 145–153. <https://doi.org/10.1002/jpln.200900231>
- Mosquera-Losada, M.R., Muñoz-Ferreiro, N., Rigueiro-Rodríguez, A., 2010. Agronomic characterisation of different types of sewage sludge: Policy implications. *Waste Manag.* 30, 492–503. <https://doi.org/10.1016/j.wasman.2009.09.021>
- SAS, 2001. SAS/Stat User’s Guide: Statistics. SAS Institute Inc., Cary, NC, USA.

## **N<sub>2</sub>O EMISSIONS FROM CROP RESIDUES VARY GREATLY WITH RESIDUE QUALITY AND MANAGEMENT**

OLESEN, J.E.<sup>1</sup>, RECOUS, S.<sup>2</sup>, HANSEN, S.<sup>3</sup>, JENSEN, E.S.<sup>4</sup>, BUTTERBACH-BAHL, K.<sup>5</sup>, REES, R.M.<sup>6</sup>, BLEKEN, M.A.<sup>7</sup>, SMITH, K.E.<sup>8</sup>, ERNFORS, M.<sup>4</sup>, LAVILLE, P.<sup>2</sup>, LASHERMES, G.<sup>2</sup>, LOUBET, B.<sup>2</sup>, MASSAD, R.<sup>2</sup>, PETERSEN, S.O.<sup>1</sup>, THORMAN, R.E.<sup>8</sup>, TAGHIZADEH-TOOSI, A.<sup>1</sup>, TOPP, C.F.E.<sup>6</sup>

<sup>1</sup> Aarhus University, Denmark; <sup>2</sup> INRA, France; <sup>3</sup> NORSØK, Norway; <sup>4</sup> SLU, Sweden; <sup>5</sup> KIT, Germany; <sup>6</sup> SRUC, UK; <sup>7</sup> NMBU, Norway; <sup>8</sup> ADAS, UK

### **INTRODUCTION**

The nitrogen (N) content of crop residues is used in national greenhouse gas (GHG) emission inventories to estimate nitrous oxide (N<sub>2</sub>O) emissions from agriculture. Crop residues also make a major contribution to sustaining or enhancing soil carbon (C) stocks and soil fertility. Depending on the amount of C and N in crop residues and their contributions to N<sub>2</sub>O emissions or to the soil C and N balance, residues might increase or decrease the GHG footprint of agricultural systems. In 2015, 21.7 Mt CO<sub>2e</sub> were released as N<sub>2</sub>O from agricultural crop residues in EU (EEA, 2017), making it the third largest source of direct N<sub>2</sub>O emissions from agricultural soils. Yet the quantification of this source has largely been neglected, so that the current estimations of N<sub>2</sub>O emissions from crop residues are associated with some of the largest uncertainties in national GHG inventories. These uncertainties relate to: 1) the amount and N concentration of the returned residue; 2) the magnitude of N<sub>2</sub>O emissions associated with the application of crop residues of different quality to soils; and 3) how N<sub>2</sub>O emissions and uncertainties differ with crop species, soils, climate and management practices. Recent studies suggest that the concurrent C and N transformations are critical for N<sub>2</sub>O emissions from crop residues.

### **MATERIAL AND METHODS**

A new European research project (ResidueGas), started in autumn 2017, will address the estimation of N<sub>2</sub>O emissions from crop residues, including cover crops and incorporation of grassland swards. The project aims to:

- propose a new and improved methodology to estimate N<sub>2</sub>O emissions associated with crop residues for the most important cropping systems in Northern Europe, for use in national emissions inventories.
- assess the relative importance of crop residue management for total N<sub>2</sub>O emissions and the C and N balance of agricultural soils across different cropping and residue management systems for various pedoclimatic conditions, as a basis for the identification and implementation of mitigation strategies.

ResidueGas will suggest a new method to account for N<sub>2</sub>O emissions from soil receiving crop residues through reviewing existing findings and data, targeted experimental studies for Europe, and improved modelling, suggest a new method to account for N<sub>2</sub>O emissions from soil receiving crop residues. Furthermore, ResidueGas will evaluate the mitigation potential of a combination of practices on soil organic carbon (SOC) storage and N<sub>2</sub>O emissions from residue incorporation and develop new software tools that will assist in identifying the best mitigation options. An improved understanding of underlying processes will help further developing biogeochemical models for simulating N<sub>2</sub>O emissions and SOC storage, and testing these effects under field conditions. The improved models will be used as the basis for developing a residue-targeted decision support system, for estimating soil N<sub>2</sub>O and SOC changes in typical crop rotations, soils and agro-environmental zones in Europe. Simulations will be aggregated into a meta-model representing a simplified, but greatly improved and operational approach to estimate residues effects on soil N<sub>2</sub>O emissions and SOC stocks.

### **RESULTS AND DISCUSSION**

Preliminary hypotheses in the ResidueGas project illustrate the importance of critical moments during crop management cycles for N<sub>2</sub>O emissions from crop residues. High N<sub>2</sub>O emissions have been associated with low residue C:N ratios (Charles et al., 2017), but residue C and its degradability are also important for emissions (Li et al., 2016), and in some cases may be a more significant driver than total N input (Pugesgaard et al., 2016). This

indicates that crop residue properties, beyond N supply, such as chemical composition, and the mode of residue applications to soils influence N<sub>2</sub>O emissions, and that C and N availability in residues as well as management need to be considered. The following components of cropping systems, which may be particularly at risk for large N<sub>2</sub>O emissions and should be better studied for inclusion in inventories and for mitigation:

- Incorporation of fresh crop residues after harvesting in summer or autumn of vegetative crops, like vegetables, potatoes and sugar beet
- Winter periods where crop residues remain on the soil surface (not incorporated). Effects are linked to timing of soil tillage and the effects of freeze-thaw on decomposition and N<sub>2</sub>O fluxes at low temperature.
- Incorporation in spring of N-rich residues of cover crops, in particular when these cover crops are ploughed and this is associated with addition of N in mineral fertilisers or manure.
- Cover crops that are frost killed during winter (e.g. Brassica species) giving conditions for decomposition of degradable C and N compounds, and thus for N<sub>2</sub>O emissions.
- Termination of grasslands (in particular grass-clover swards) where degradable C and N in the incorporated plant materials can support denitrification.

The effects of crop residue quality on N<sub>2</sub>O emissions is anticipated to be linked to soil type and soil properties, as well as the method and timing of residue incorporation in soil (Li et al., 2015). Crop residue management is only to a very limited extent included as part of policy measures to reduce agricultural GHG emissions. Emissions reductions can only be effectively incentivized and implemented as mitigation measures, if there are documented and verified effects of mitigation options reflected in national inventories, and if uncertainties can be significantly reduced. Such efforts require focus on the critical moments for N<sub>2</sub>O emission identified above.

## CONCLUSION

Current IPCC methodology to estimate N<sub>2</sub>O emissions from crop residues fails to capture the large variability in quality of the crop residues, where emissions of N<sub>2</sub>O are not only related to the N availability of the crop residues, but also to the availability of degradable carbon enhancing microbial activity and oxygen demand that, in turn, contribute to determining the denitrifying environment in the soil.

**Acknowledgements:** ResidueGas is funded through the ERA-GAS network partly by the EU Horizon 2020 programme and partly by national funding bodies.

## REFERENCES

- EEA, 2017. Annual European Union greenhouse gas inventory 1990–2015 and inventory report 2016. EEA Report No 15/2016.
- Charles, A., Rochette, P., Whalen, J.K., Angers, D.A., Chantigny, M.H., Normand, B., 2017. Global nitrous oxide emission factors from agricultural soils after addition of organic amendments: A meta-analysis. *Agric. Ecosyst. Environ.* 236, 88-98.
- Li, X., Petersen, S.O. et al., 2015. Effects of contrasting catch crops on nitrogen availability and nitrous oxide emissions in an organic cropping system. *Agric. Ecosyst. Environ.* 199, 382-393.
- Li, X., Sørensen, P., Olesen, J.E., Petersen, S.O., 2016. Evidence for denitrification as main source of N<sub>2</sub>O emission from residue-amended soil. *Soil Biol. Biochem.* 92, 153-160.
- Pugesgaard, S., Petersen, S.O., Chirinda, N., Olesen, J.E., 2017. Crop residues as driver for N<sub>2</sub>O emissions from a sandy loam soil. *Agric. For. Meteorol.* 233, 45-54.

# Polysulphate

## Our family of fertilizers works for you

ICL Fertilizers develop Polysulphate based products for cost-effective, efficient and reliable plant nutrition around the world.

[www.polysulphate.com](http://www.polysulphate.com)



 **BASF**

We create chemistry

## Keeping nitrogen on target

Nitrogen use efficiency from BASF

To learn more visit [agro.basf.com](http://agro.basf.com)



**Partenaire  
de l'agriculture  
et l'industrie françaises  
depuis 5 ans**



Présence commerciale  
dans 84 pays



16 sites de  
production sur 4 pays



**80 ans...**  
*... au service de l'agriculture  
du Grand Ouest !*

**BIO3G**  
L'AGRONOME



**Knowledge grows**



# N

**SESSION 1** • N Cycle in landscapes

**SESSION 2** • Regional studies

**SESSION 3** • Local process studies

**SESSION 4** • Studies and mitigation options at the farm level

WITH THE FINANCIAL SUPPORT OF

DIAMOND



Knowledge grows

GOLD



SILVER



PUBLIC SUPPORT



<https://workshop.inra.fr/nitrogenworkshop2018>